



CITY OF EL PASO  
**BIKE PLAN**

August 2016





# CITY OF EL PASO BIKE PLAN

## City of El Paso

Capital Improvement Department-  
Planning Division

Fred Lopez, AICP  
Jim Fisk, AICP  
Kevin Smith  
Sergio Reyes, P.E.

## Internal Steering Committee

Tony Bustillos  
Lauren Baldwin  
Margaret Schroeder  
Everett Esparza  
Sandra Hernandez  
Marty Boyd  
Alfredo Austin  
Ryan Kirby  
Claudia Garcia  
Christine Ponce-Diaz  
Ismael Segovia  
Justin Bass, AICP  
Domingo Cordero  
Rudy Pino  
Jiann-Shing Yang  
Hannah Williams  
Mike Medina  
Nicole Ferrini

## Bicycle Advisory Committee

Oscar Aguilar  
Ruben Chavez  
John Eyberg  
Robert Gonzales  
Leonard Gutierrez  
Jose Luis Loya II  
Melissa Lugo  
Cesar Martinez  
Scott White

## City Council

Peter Svarzbein, District 1  
Jim Tolbert, District 2  
Emma Acosta, District 3  
Carl Robinson, District 4  
Dr. Michiel Noe, District 5  
Claudia Ordaz, District 6  
Lily Limon, District 7  
Cortney Niland, District 8  
Oscar Leeser, Mayor

## City Plan Commission

Edith Brannon  
Diana Marie Perez  
Jayvant Desai  
Tony Benitez  
Rebeca Bustamante  
Charlie Madrid  
Margaret Livingston  
Robert Ardivino

## Consultant Team:



## Alta Planning + Design, Inc.

Paul Wojciechowski, PE,  
Principal  
Catrine Machi, Project  
Manager  
Kevin Neill  
Kristine Neurauter  
Kristen O'Toole  
Mandia Gonzales



## AECOM

Chuck Berry, PE  
Keith Dewey, AICP  
Allison Kaplan



## Barracuda Public Relations

Marina Monsisvais  
Alejandra Munoz  
Ana Gabriela Becerra  
Martin Bartlett  
Alejandra Urquide



## Quantum Engineering

Robert A. Gonzales, PE, CNU-A  
Wendy M. Arredondo, EIT, CNU-A



## Table of Contents

Executive Summary . . . . .	6	Network and Facility Recommendations .	67
Vision, Goals, and Objectives. . . . .	6	Program Recommendations . . . . .	78
Existing Conditions . . . . .	6	Policy Recommendations . . . . .	93
Network Analysis and Methods. . . . .	7	Implementation. . . . .	98
Recommendations . . . . .	7	Bike Network Prioritization . . . . .	98
Vision and Goals . . . . .	10	Maintenance . . . . .	101
Existing Conditions . . . . .	24	Strategies for Working Between Departments . . . . .	102
Planning and Policy Context . . . . .	24	Funding Sources . . . . .	106
The Bicycle Network . . . . .	26	Appendix A: Existing Plans and Policies Summary	
Programs and Partner Organizations. . . . .	31	Appendix B: Bike Network Atlas	
Opportunities and Constraints. . . . .	35	Appendix C: Design Guidelines	
Needs Analysis and Methods. . . . .	37		
Design Users . . . . .	37		
Bicycle Suitability Index . . . . .	38		
Bicycle Demand Analysis. . . . .	39		
Bicycle Level of Traffic stress. . . . .	48		
Collision and Safety Analysis. . . . .	50		
Public Engagement. . . . .	60		
Recommendations . . . . .	67		

## Table of Maps

Map 1 Existing bikeways . . . . .	25
Map 2 Bicycle facility demand: live. . . . .	40
Map 3 Bicycle facility demand: work . . . . .	41
Map 4 Bicycle facility demand: learn-primary/ secondary. . . . .	42
Map 5 Bicycle facility demand: learn-college/ university . . . . .	43
Map 6 Bicycle facility demand: play . . . . .	44
Map 7 Bicycle facility demand: transit . . . . .	45
Map 8 Bicycle facility demand: composite . . . . .	46
Map 9 Bicycle level of traffic stress . . . . .	51
Map 10 Low-stress connectivity clusters . . . . .	52
Map 11 Bicycle crash locations. . . . .	59
Map 12 Future bicycle level of traffic stress . . . . .	74
Map 13 Future low-stress connectivity clusters 75	
Map 14 Recommended bikeway network . . . . .	76
Map 15 Network prioritization . . . . .	99

## Table of Tables

Table 1. Existing Bicycle Network by Facility Type . . . . .	26
Table 2. Bicycle Suitability Index Data Sources. 39	
Table 3. Sources of Model Inputs . . . . .	49
Table 4. Segment Scoring Matrix for Bicycle Level of Traffic Stress . . . . .	50
Table 5. Intersection Scoring Matrix for Bicycle Level of Traffic Stress . . . . .	50
Table 6. Roadways with the Highest Number of Crashes. . . . .	54
Table 7. Recommended Network Mileage . . . . .	72
Table 8. Characteristics of Short- and Long- Term Bicycle Parking . . . . .	73
Table 9. Potential Partners. . . . .	92
Table 10. Prioritization Criteria . . . . .	100
Table 11. Cost Estimates for Recommended Bikeway Types . . . . .	101
Table 12. Recommended Bikeway Network, Annual Operation and Maintenance Cost Estimates . . . . .	102

## Section 1: Executive Summary

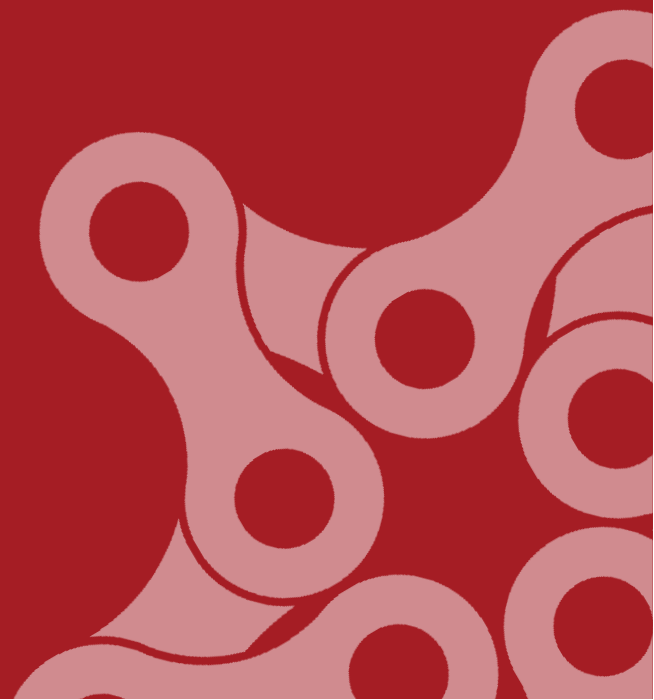

# Executive Summary

A bike plan is a document that guides city staff and elected officials in deciding what streets are best for bicycling, how to make those streets safer for cycling, and what other policies and programs can be made to support the changes in the street. The goals, objectives, and recommended improvements in this plan are based on four key elements: field work, public input, technical analysis, and feedback from city staff and partnering agencies. The City of El Paso Bike Plan is a bold vision of the future of bicycling in the city.

## Vision, Goals, and Objectives

City of El Paso staff created a vision statement to establish the framework for the Bicycle Master Plan.

El Paso will be one of the most bicycle-friendly cities in the country by implementing and evaluating its goals, promoting bicycling as a viable, safe, everyday activity.

The team, consisting of City staff, Bicycle Advisory Committee (BAC), and consultants, then established six goals to guide the evolution of bicycling in the City:

- **Goal 1:** The City of El Paso will be a Silver Level bicycle-friendly community.<sup>1</sup>
- **Goal 2:** El Paso's land use and planning policies and practices will contribute to and enhance the city's bicycle friendliness.
- **Goal 3:** El Paso will work closely and coordinate planning, design, implementation, and maintenance of bicycle improvements with all City departments, El Paso County, the El Paso Metropolitan Planning Organization (EPMPO), Texas Department of Transportation (TxDOT), Fort Bliss, Doña Ana County, Ciudad Juárez, and other adjacent communities and

regional partners in order to enhance the regional comprehensive transportation system and make the bicycle network as cohesive and seamless as possible.

- **Goal 4:** El Paso will have a complete network of bicycle-friendly infrastructure suitable for all abilities, ages, and user types throughout the City.
- **Goal 5:** El Paso will support programs that educate, increase awareness and safety, promote a healthy and sustainable community, evaluate bicycling impacts, improve tourism opportunities, and foster positive attitudes about bicycling.
- **Goal 6:** The City of El Paso will encourage and promote bicycling at every department of civic government and encourage the regional government to do the same.

Objectives were identified for each of these goals and are presented with current strategy, an approach to achieving the objective, a time line for completion, and key players required to achieve the objective.

## Existing Conditions

The team reviewed the existing bicycle network and existing plans, policies, and programs related to bicycling in El Paso to understand the current state of infrastructure and culture in the city. The team identified existing facilities (both on-street and off-street facilities), the grid network of the street, and existing traffic-calming

<sup>1</sup> A community recognized by the League of American Bicyclists as a *Bicycle-Friendly Community (BFC)* is one that welcomes cyclists with trails, bike lanes, share the road campaigns, organized rides, Bike to Work Day events and so much more. A rich matrix of options that recognizes your area's unique resources, the BFC application evaluates how your community encourages people to bike for transportation and recreation through the five Es: engineering, education, encouragement, enforcement, and evaluation. Award levels are ranked by the League based on these options and awarded from highest to low as: Platinum, Gold, Silver, and Bronze.

measures as opportunities to develop a complete network in the city, while existing mountainous terrain and busy roads offer some barriers to encouraging cycling.

## Network Analysis and Methods

The existing bicycle infrastructure was analyzed to evaluate its suitability for bicycling. The bicycle level of stress analysis provided a picture of the quality of bicycle infrastructure. The results show that, while many of the city's streets offer a low-stress environment for bicycling, arterial and collector roadways and other major barriers create challenges for people traveling by bicycle to school, to work, to transit, or for everyday daily trips.

The team also engaged the public for comments on bicycle infrastructure through a series of public workshops, community meetings, and online maps. The public identified the following concerns and desires for the bicycle network:

- Connectivity between points of interest and residential and commercial areas
- Safety of existing infrastructure
- Maintenance of existing infrastructure
- Additional off-road infrastructure, including use of canals or utility infrastructure
- Rideability concerns, such as steep hills
- Safer intersections
- Additional bike share facilities
- Lack of end-of-trip facilities such as bike parking
- More education and encouragement, including law enforcement
- Improvements to aesthetics, such as landscape or public art

This information was integrated into the recommended bicycle network.

## Recommendations

The plan includes a comprehensive set of policy, programming, and bikeway recommendations specifically designed to help El Paso become one of the most bicycle-friendly cities in the United States. These recommendations are built on a solid foundation of extensive public engagement and input, supported by thorough

technical analysis and field work. Bicycle network recommendations focus on building an interconnected system of on-street and off-street bikeways that supports safe, comfortable, and convenient travel, regardless of trip purpose. Program recommendations support safe and regular bicycle use among El Paso residents and visitors, as well as respectful and responsible use of public streets and trails by all user types, including people bicycling, walking, and driving motor vehicles. Policy recommendations address the framework for funding, designing and operating the bike network, built on consistent procedures and clear roles for and relationships among city departments and with external agencies and organizations.

## Implementation

Creating the improved network requires a methodical approach. The team developed planning-level costs for the recommended network. Each segment of the recommended bicycle network was then evaluated and scored using a set of criteria—including connectivity to other facilities and transit and construction and maintenance costs—in order to recommend a strategy to implement the network improvements. This information will inform the City of El Paso as it begins to construct the infrastructure recommended in the plan.

El Paso's bike plan implementation data should be monitored and compared to other US cities' progress. The *El Paso Bike Plan* should be considered an evolving document. City staff along with BAC will periodically monitor implementation progress to measure the progress of bike plan completion and update the plan every ten years.

This planning effort is consistent with and contributes to the goals of the long-term investment and implementation in the planned Active Transportation System within the El Paso and Mesilla Valley MPO and Instituto Municipal de Investigacion y Planeacion (IMIP). The Active Transportation System links existing trails and shared-use paths throughout the region with the intent of promoting active transportation. This plan connects the on-street bikeway with trails and shared-use paths.



This page left blank intentionally.

## Section 2: Vision and Goals



## Vision and Goals

City of El Paso staff, with input from the Internal Steering Committee and the public, created a vision statement to establish the framework for the Bicycle Master Plan and developed goals based on existing planning documents and community input. Each goal has a series of objectives, which are more specific actions that support each goal, to shape actions that will carry out the plan. Performance measurements will help the City to track its progress towards meeting the goals and objectives of the plan, focusing on accountability and motivation in carrying it out. This chapter introduces the vision, goals, and objectives for the plan.



### Vision:

El Paso will be one of the most bicycle-friendly cities in the country by implementing and evaluating its goals, promoting bicycling as a viable, safe, everyday activity.



## Goal 1:

The City of El Paso will be a Silver-level Bicycle-Friendly Community.

### Objective 1

**Develop a strategy to achieve Silver level designation as a Bicycle-Friendly Community by the League of American Bicyclists (LAB).**

*Goal date:* January 2018

*Current strategy:* No current defined strategy

*Future measures:* Carry out action plan from the Bike Plan to achieve Bronze designation in 2016 and Silver in 2018 from LAB.

#### Key players:

- City Council and Mayor
- City Manager's Office
- Sun Metro
- Capital Improvement Department-Planning Division
- Bicycle Advocacy
- Camino Real Regional Mobility Authority (CRRMA)
- City of El Paso Public Information Office
- Bicycle/Pedestrian Coordinator

### Objective 2

**Foster a greater sense of community and neighborhood by improving the visibility of bicyclists and pedestrians.**

*Goal date:* January 2017

*Current strategy:* No current defined strategy

*Future measures:* One online survey to be conducted per year including questions related to visibility of bicyclists and pedestrians. Favorable impression of bicyclists and pedestrians to be measured, benchmarked, and increased by 10 percent per year. Results to be published on the City of El Paso's website.

#### Key players:

- City Council and Mayor
- City Manager's Office
- Capital Improvement Department-Planning Division
- Local School Districts
- Bicycle Advocacy
- Bicycle/Pedestrian Coordinator
- Neighborhood Associations



## Goal 2:

El Paso's land use and planning policies and practices will contribute to and enhance the city's bicycle friendliness.

### Objective 1

**Integrate the bicycling and transit networks and improve El Paso residents' ability to link bicycling and transit trips. Update regional Google "trip planner" to include a multimodal search with links to bike and bus express routes for time-competitive travel.**

*Goal date:* January 2025

*Current strategy:* No current defined strategy

*Future measures:* Regional Google trip planner to be updated by January 2025. Bike share usage within 1/2 mile of transit stops to be measured by SunCycle and data shared with the City of El Paso. Sun Metro should consider tracking the number of transit riders using bicycles.

#### *Key players:*

- Capital Improvement Department-Planning Division
- Sun Metro
- SunCycle
- City of El Paso Public Information Office
- Bicycle/Pedestrian Coordinator

### Objective 2

**Increase the number and quality of places to ride bicycles in the City and its environs.**

*Goal date:* July 2020

*Current strategy:* 140 miles of existing bicycle lanes/paths/wide shoulders

*Future measures:* Fund and implement recommended bicycle facilities from Bike Plan, closing gaps and connecting destinations, 20 percent each year until complete.

#### *Key players:*

- City Council and Mayor
- Parks and Recreation Department
- Capital Improvement Department-Planning Division
- Bicycle/Pedestrian Coordinator
- Streets and Maintenance Department
- TxDOT
- El Paso Water Utilities

### Objective 3

**Create complete, standardized networks of multi-modal streets with ample shaded sidewalks, bicycle facilities, and frequent on-street parking that is clearly defined from the bicycle lane to demonstrate and delineate door zones.**

*Goal date:* January 2025

*Current strategy:* No adopted plan

*Future measures:* Identify Great Streets priority network and incorporate into the Capital Improvement Program (CIP) by 2017. Identify two major Great Streets per year.

#### *Key players:*

- Capital Improvement Department-Planning Division
- Streets and Maintenance Department
- Sun Metro
- Planning and Inspections Department
- Bicycle/Pedestrian Coordinator
- TxDOT



#### Objective 4

Encourage development along existing or planned bicycle networks where additional segments and secure bicycle storage can be added to the network.

Goal date: January 2017

Current strategy: No current defined strategy

Future measures: Development plans along bicycle routes to be identified in the permitting phase; bicycle/pedestrian coordinator to be involved in permitting process; bicycle parking to be required by ordinance for development along existing/planned bicycle routes.

Key players:

- Capital Improvement Department-Planning Division
- Planning and Inspections Department
- Parks and Recreation Department
- Economic and International Development
- Bicycle/Pedestrian Coordinator

#### Objective 5

Transform existing streets, both large and small, using appropriate traffic-calming that is built into the design of the street, in order to restore balance to their design so that pedestrians and bicyclists feel safe and comfortable.

Goal date: January 2025

Current strategy: Existing Neighborhood Traffic Management Program

Future measures: Increase number of traffic-calming installations each year.

Key players:

- Capital Improvement Department-Planning Division
- Streets and Maintenance Department
- County of El Paso
- Planning and Inspections Department
- TxDOT
- El Paso Metropolitan Planning Organization
- Utility Companies
- Bicycle/Pedestrian Coordinator

#### Objective 6

The City of El Paso will improve its thoroughfares and wide arterial roads over time as opportunities are found to increase transit service and improve connectivity, walkability, bikeability, and economic benefits to surrounding areas.

Goal date: January 2025

Current strategy: Existing Major Thoroughfare Plan

Future measures: Identify and publish on the City's website the number of new buffered or protected bike lanes and striped bike lanes on thoroughfares and arterials each year.

Key players:

- Capital Improvement Department-Planning Division
- Streets and Maintenance Department
- County of El Paso
- Planning and Inspections Department
- TxDOT
- El Paso Metropolitan Planning Organization
- El Paso Water Utilities
- Utility Companies
- Bicycle/Pedestrian Coordinator

### Objective 7

Update bicycle parking requirements to include short- and long-term parking facilities and standards through a citywide bicycle parking plan. This plan will update bicycle parking requirements with refined bicycle parking ratios and graphic standards that depict bicycle parking type, placement, and location standards that require an adequate amount of secure properly positioned bicycle parking at key trip attractors and generators throughout the community. The parking requirements will require commercial and residential developments to provide suitable areas for bus stops with bicycle storage and encourage employers to remove subsidies for parking and provide financial incentives to cycling, transit, and walking as a commuting alternative, and to include showers, lockers, and changing areas at places of employment.

Goal date: July 2020

Current strategy: Bicycle parking required in El Paso City Code, Title 20, Appendix C-Table of Parking Requirements and Standards

*Future measures:* Complete survey of bicycle parking and publish results on City website. Update City's land development code (Section 20.14.070) to reflect bicycle parking best practices and incentivize parking requirement reductions in exchange for building bicycle parking, showers, lockers, and changing areas.

#### Key players:

- Streets and Maintenance Department
- Parks and Recreation Department
- Capital Improvement Department-Planning Division
- Planning and Inspections Department
- Sun Metro
- Community and Human Development
- Development Community
- University of Texas at El Paso
- El Paso Community College
- Bicycle/Pedestrian Coordinator
- City Manager's Office
- City Council and Mayor



## Goal 3:

Work closely and coordinate planning, design, implementation, and maintenance of bicycle improvements with all City departments, El Paso County, EPMPO, TxDOT, Fort Bliss, Doña Ana County, Ciudad Juárez, and other adjacent communities and regional partners in order to enhance the regional comprehensive transportation system and make the bicycle network as cohesive and seamless as possible.

### Objective 1

**Utilize the principles described in *Plan El Paso* to plan, design, and implement bicycle infrastructure in conjunction with other City plans and projects.**

*Goal date:* June 2020

*Current strategy:* Principles highlighted in *Plan El Paso*, Great Streets Design Guidelines

*Future measures:* Master list of other City plans and projects to be maintained and consulted prior to bicycle infrastructure project plan implementation; Great Streets Design Guidelines to be used as guideline for all identified Great Streets and consulted for reference in non-Great Streets projects (when approved); National Association of City Transportation Officials (NACTO) *Urban Street Design Guide* as applicable to all projects.

#### *Key players:*

- Capital Improvement Department-Planning Division
- Planning and Inspections Department
- Streets and Maintenance Department
- TxDOT
- Fort Bliss
- El Paso Metropolitan Planning Organization
- Bicycle/Pedestrian Coordinator
- El Paso Water Utilities

### Objective 2

**Include bicycle facilities in the City's capital projects, and coordinate with utility companies, the county water improvement districts, Franklin Mountain State Park, TxDOT, El Paso County, other municipalities, and the EPMPO to ensure bicycle infrastructure is included in their capital improvement plans.**

*Goal date:* January 2018

*Current strategy:* No current defined strategy

*Future measures:* Bicycle projects will be added in coordination with associated infrastructure projects in the City CIP; bicycle/pedestrian coordinator will coordinate with other entities to include bicycle infrastructure in their CIP.

#### *Key players:*

- City Council and Mayor
- City Manager's Office
- Capital Improvement Department-Planning Division
- El Paso Water Utilities
- El Paso Metropolitan Planning Organization
- TxDOT
- County of El Paso
- El Paso Community College
- University of Texas at El Paso
- Municipalities
- Planning and Inspections Department
- Bicycle/Pedestrian Coordinator

### Objective 3

**Create cross-border multimodal transportation choices.**

*Goal date:* January 2018

*Current strategy:* Existing bicycle and pedestrian lanes on international bridge

*Future measures:* Increase percentage of bicyclists and pedestrians crossing border by 2 percent per year.

*Key players:*

- City Council and Mayor
- City Manager's Office
- Capital Improvement Department-Planning Division
- Streets and Maintenance Department
- Planning and Inspections Department
- International Bridges Department
- Bicycle/Pedestrian Coordinator
- El Paso Water Utilities
- Ciudad Juárez
- US Government Border Patrol

*Objective 4*

**Work with Parks and Recreation Department, Water Improvement District, Gas Utilities, State Parks and Wildlife, Franklin Mountain, Hueco Tanks, US Boundary and Water Commission, Texas Commission and TxDOT (where appropriate), to increase pedestrian and bicyclist connectivity across natural and man-made barriers such as freeways, ravines, river beds, canyons, and arroyos.**

*Goal date:* January 2020

*Current strategy:* No current defined strategy

*Future measures:* Identify and publish on the City's website the number of pedestrian and bicycle connectivity barriers addressed each year.

*Key players:*

- City Council and Mayor
- City Manager's Office
- El Paso Water Utilities
- TxDOT
- County of El Paso
- Parks and Recreation Department
- Capital Improvement Department-Planning Division
- Streets and Maintenance Department
- El Paso County Water Improvement District No. 1
- University of Texas at El Paso
- El Paso Community College
- Office of Resilience + Sustainability
- Bicycle/Pedestrian Coordinator

*Objective 5*

**Provide shorter and more convenient routes for non-motorized traffic across barriers.**

*Goal date:* January 2020

*Current strategy:* No current defined strategy

*Future measures:* Identify and publish on the City's website the number of pedestrian and bicycle connectivity barriers addressed each year.

*Key players:*

- El Paso Water Utilities
- TxDOT
- County of El Paso
- Parks and Recreation Department
- Capital Improvement Department-Planning Division
- Streets and Maintenance Department
- El Paso County Water Improvement District No. 1
- University of Texas at El Paso
- El Paso Community College
- Office of Resilience + Sustainability
- Bicycle/Pedestrian Coordinator

*Objective 6*

**Ensure that there is seamless coordination between all City departments that could possibly be involved in improving or affecting the bicycle network.**

*Goal date:* January 2017

*Current strategy:* Existing BAC

*Future measures:* Bicycle/pedestrian coordinator to conduct quarterly conference call/meeting of city departments to discuss project list.

*Key players:*

- City Council and Mayor
- City Manager's Office
- El Paso Water Utilities
- Streets and Maintenance Department
- Capital Improvement Department-Planning Division
- Parks and Recreation Department
- El Paso Police Department
- Sun Metro
- Economic and International Development Department
- Bicycle/Pedestrian Coordinator

## Goal 4:

El Paso will have a complete network of bicycle-friendly infrastructure suitable for all abilities, ages, and user types throughout the City.

### Objective 1

**Implement standards for the design, planning, construction, and maintenance of infrastructure.**

*Goal date:* January 2018

*Current strategy:* Existing El Paso street cross sections

*Future measures:* Adopt new City street cross section standards that include Great Streets standards.

#### *Key players:*

- Streets and Maintenance Department
- Capital Improvement Department-Planning Division
- Parks and Recreation Department
- TxDOT
- County of El Paso
- Bicycle/Pedestrian Coordinator
- El Paso Water Utilities

### Objective 2

**Implement safe and accessible facilities that are comfortable for all users, especially on major roads where the amount and the speed of traffic would normally deter most people from riding a bike.**

*Goal date:* January 2017

*Current strategy:* No current defined strategy

*Future measures:* The minimum standard for arterials will be buffered or protected bikeways; minimum standard for collectors will be striped bike lanes.

#### *Key players:*

- Streets and Maintenance Department
- Capital Improvement Department-Planning Division
- Planning and Inspections Department
- Parks and Recreation Department
- TxDOT
- County of El Paso
- Bicycle/Pedestrian Coordinator

### Objective 3

**Connect the bike share system to existing and proposed bicycling and walking facilities.**

*Goal date:* January 2020

*Current strategy:* Existing SunCycle system

*Future measures:* 100 percent of new bike share stations to be located on existing or proposed bicycle network

#### *Key players:*

- Streets and Maintenance Department
- Capital Improvement Department-Planning Division
- Planning and Inspections Department
- Parks and Recreation Department
- TxDOT
- County of El Paso
- EPMPO
- University of Texas at El Paso
- Fort Bliss
- El Paso Community College
- Bicycle/Pedestrian Coordinator



#### Objective 4

**Provide streetlights that improve safety for drivers, bicyclists, and pedestrians while complying with the dark sky ordinance and reducing light pollution.**

*Goal date:* January 2025

*Current strategy:* Streetlight maintenance program

*Future measures:* Audit of areas needing streetlights, and streetlights that are updated to national standards, to be completed by 2018. Streetlights to be installed by 2025. Maintain existing streetlights.

*Key players:*

- County of El Paso
- Streets and Maintenance Department
- TxDOT
- Capital Improvement Department-Planning Division
- Bicycle/Pedestrian Coordinator

#### Objective 5

**Provide safe and convenient crossings at intersections and mid-block, where needed. Improvements that create safe and convenient crossings at intersections may include different bike lane crossing treatments like green-colored markings, bike boxes, turn queue boxes, median cut-throughs for bikes, and raised cycle track crossings of interchanges.**

*Goal date:* January 2020

*Current strategy:* Maintained crosswalks as part of street maintenance

*Future measures:* Audit of high-risk intersections and areas needing midblock crossings to be completed by 2020. Safe crossings to be included with all street resurfacing/restoration/new build projects. City's 311/citizen reporting system to be updated to allow the City to address bicyclists' issues with a work order through maintenance or a proposed project.

*Key players:*

- Streets and Maintenance Department
- TxDOT
- County of El Paso
- Capital Improvement Department-Planning Division
- Bicycle/Pedestrian Coordinator

#### Objective 6

**Implement a regular bicycle network maintenance program, with priority given to bicycle lanes and primary bicycle routes, in order to encourage people to choose bicycling year round.**

*Goal date:* January 2018

*Current strategy:* No current defined strategy

*Future measures:* Maintenance guidelines will be provided to Public Works, and annual budgets will be adjusted to include maintenance.

*Key players:*

- Streets and Maintenance Department
- Capital Improvement Department-Planning Division
- TxDOT
- County of El Paso
- Bicycle/Pedestrian Coordinator



## Goal 5:

El Paso will support programs that educate, increase awareness and safety, promote a healthy and sustainable community, evaluate bicycling impacts, improve tourism opportunities, and foster positive attitudes about bicycling.

### Objective 1

**Raise awareness that riding a bicycle is a viable and easy-to-use form of transportation and recreation, helping to eliminate the perception that experienced (fast and fearless) bicyclists are the only people who ride bicycles.**

*Goal date:* January 2017

*Current strategy:* Existing police department trainings

*Future measures:* Educational materials will be handed out to 300 people per year. Electronic brochures focusing on drivers will be created and hosted on Police websites. A bicycle program page will be created for the City website; all materials will be hosted on this page. City will use social media to disseminate information during Bike Month.

#### Key players:

- City Council and Mayor
- El Paso Metropolitan Planning Organization
- Chamber of Commerce
- Environmental and Code Enforcement
- Office of Resilience + Sustainability
- Sun Metro
- Police Department
- Economic and International Development Department
- Convention and Visitors Bureau
- Capital Improvement Department-Planning Division
- Parks and Recreation Department
- Streets and Maintenance Department
- Bicycle/Pedestrian Coordinator
- Department of Public Health

### Objective 2

**Improve bicyclist and motorist safety by improving infrastructure and educating users about safe bicycle riding and driving skills.**

*Goal date:* January 2017

*Current strategy:* Existing police department trainings

*Future measures:* Include bicycle safety in defensive driving courses. City to offer four Traffic Skills 101 (TS101) bicycle skills classes per year. City to host an LCI (League Cycling Instructor) training once every two years.

#### Key players:

- City Council and Mayor
- El Paso Metropolitan Planning Organization
- Capital Improvement Department-Planning Division
- Streets and Maintenance Department
- Advocacy Groups
- Police Department
- Bicycle/Pedestrian Coordinator
- Department of Community and Human Development

### Objective 3

**Promote innovative recreational, educational, and cultural programs centered around bicycling. Continue to support, fund, and expand Scenic Sundays. In recent years El Paso has dramatically increased the number of its outdoor community health events such as marathons, triathlons, cyclovia, and so forth. The City should continue to support these efforts and work to increase the number, range of kinds, and attendance levels. Close low-traffic roads, especially in downtown, on selected weekend days to provide opportunities for bicyclists and those interested in bicycling to do so in a safe environment.**

*Goal date:* January 2017

*Current strategy:* Existing Scenic Sundays, health events

*Future measures:* Dedicate web page to Scenic Sundays with regularly updated information. Determine number of health-related events and increase by 10 percent

each year. Conduct study to assess impact of closing low-traffic roads downtown. Track public health research data related to active transportation. Track bike tourism data.

*Key players:*

- Schools
- Office of Resilience + Sustainability
- Economic and International Development Department
- Race Directors
- Bike Retail/Run Shops
- Police Department
- Capital Improvement Department-Planning Division
- Convention and Visitors Bureau
- Chamber of Commerce
- Streets and Maintenance Department
- Parks and Recreation Department
- Bicycle/Pedestrian Coordinator
- Advocacy Groups
- Downtown Management District
- Department of Public Health

*Objective 4*

**Reduce collisions involving pedestrians, bicyclists, and motor vehicles and aspire to reach zero pedestrian and bicyclist deaths.**

*Goal date:* January 2020

*Current strategy:* No current defined strategy

*Future measures:* Create Vision Zero policy in El Paso and districtwide. Publish annual data that show high motor vehicle-pedestrian and motor vehicle-bicycle crash sites. Create Vision Zero action plan to address high-crash sites.

*Key players:*

- City Council and Mayor
- Police Department
- Capital Improvement Department-Planning Division
- Advocacy Groups
- Streets and Maintenance Department
- Bicycle/Pedestrian Coordinator
- Schools

*Objective 5*

**Implement wayfinding signing improvements along all current and proposed bikeways in order to enhance the visibility, predictability, utility, and safety of the bicycle network.**

*Goal date:* January 2019

*Current strategy:* No current defined strategy

*Future measures:* Create a uniform wayfinding plan and time line for implementation

*Key players:*

- Streets and Maintenance Department
- Capital Improvement Department-Planning Division
- Police Department
- Parks and Recreation Department
- TxDOT
- County of El Paso
- Bicycle/Pedestrian Coordinator

*Objective 6*

**Increase awareness of bicycle options and safety through trainings, police, public events, public service announcements, educational materials (bicyclists, pedestrians, children, and those who are physically impaired), and partnerships.**

*Goal date:* January 2017

*Current strategy:* Existing police department trainings

*Future measures:* 300 people will be trained in bicycling in year 2017 at public events. Three public service announcements will be run per year by year 2017. Educational materials will be handed out to 300 people per year.

*Key players:*

- City Council and Mayor
- Schools
- Police Department
- Capital Improvement Department-Planning Division
- Streets and Maintenance Department
- Advocacy Groups
- Bike Retail/Run Shops
- TxDOT
- County of El Paso
- Bicycle/Pedestrian Coordinator

## Goal 6:

The City of El Paso will encourage and promote bicycling at every department of civic government and encourage the regional government to do the same.

### Objective 1

**Maintain bicycles in the city fleet as another means of transportation for staff.**

*Goal date:* July 2017

*Current strategy:* 14 bicycles currently available to check out

*Future measures:* Encourage frequent use and track usage. Aim for 20 percent increase in usage each year.

#### *Key players:*

- City Manager's Office
- Streets and Maintenance Department
- Police Department
- Capital Improvement Department-Planning Division
- Bike Retail/Run Shops
- Bicycle/Pedestrian Coordinator
- City Council and Mayor
- Office of Resilience + Sustainability

### Objective 2

**Encourage bicycling to and from work for government employees by providing incentives, changing areas, showers, and secure parking areas.**

*Goal date:* January 2018

*Current strategy:* No current defined strategy

*Future measures:* Changing areas, showers, and secure parking areas to be available to City employees by January 2017. Package of incentives to be created and used by 5 percent of employees.

#### *Key players:*

- City Manager's Office
- Capital Improvement Department-Planning Division
- Streets and Maintenance Department
- Sun Metro
- Office of Resilience + Sustainability
- Bicycle/Pedestrian Coordinator
- City Council and Mayor

### Objective 3

**The City will explore the use of alternative funding sources to continue to support transportation options throughout the City.**

*Goal date:* January 2017

*Current strategy:* No current defined strategy

#### *Future measures*

Set a goal of a minimum number of grant funds to be secured each year for the plan and program.

#### *Key players:*

- City Manager's Office
- Capital Improvement Department-Planning Division
- Streets and Maintenance Department
- Sun Metro
- Office of Resilience + Sustainability
- Economic and International Development
- Bicycle/Pedestrian Coordinator
- El Paso Metropolitan Planning Organization
- City Council and Mayor



#### Objective 4

Create, fund, and support a bicycle and pedestrian coordinator as the steward of the bicycle master plan and future implementation.

Goal date  
January 2017

Current strategy  
City staff attend state and national transportation conferences. City hosts staff and community NACTO trainings.

Future measures  
Bicycle and pedestrian coordinator to be fully funded and hired by January 2017.

#### Key players:

- City Manager/City Manager's Office
- City Council Representatives and Mayor
- Capital Improvement Department-Planning Division
- Bicycle/Pedestrian Coordinator

#### Objective 5

Train select City staff, partners, community stakeholders, and contractors to understand or participate in bikeway design according to standards adopted by the City.

Goal date  
July 2017

Current strategy  
No current defined strategy

Future measures  
Annual trainings for City staff and police on enforcement and Best Management Practices (BMP).

#### Key players:

- Streets and Maintenance Department
- Parks and Recreation Department
- Capital Improvement Department-Planning Division
- City Consultants
- Bicycle/Pedestrian Coordinator
- City Council and Mayor
- Police Department
- Planning and Inspections Department

#### Objective 6

The City will develop funding strategies to take advantage of federal, state, and local funds that will make implementation and maintenance of the recommendations and the goals set forth in this plan.

Goal date  
January 2017

Current strategy  
No current defined strategy

Future measures  
At least 20 percent of goal grant funds to be available to match grants each year for the plan and program.

#### Key players:

- City Council and Mayor
- Office of Management and Budget
- Bicycle/Pedestrian Coordinator
- Streets and Maintenance Department
- Capital Improvement Department-Planning Division
- Economic and International Development
- Office of Resilience + Sustainability





## Section 3: Existing System



## Existing Conditions

This chapter provides a snapshot of current conditions for bicycling in El Paso and documents the City's progress toward creating a bicycle-friendly community. It begins with a brief overview of the plans and documents that have provided a framework for bicycle facility development over the last thirty years, followed by an inventory of the City's existing bicycle facilities and traffic-calming measures. The chapter concludes with a general summary of the overarching opportunities and constraints that will impact the development of bicycle facilities and the overall bikeway network in the coming years. This will be an integral part of the overall program to create a culture of bicycling in the City of El Paso.

The bicycling environment in the City of El Paso continues to evolve. The growing number of bicycle lanes and shared use paths, like the buffered bike lane on Montwood Drive and the Pat O'Rourke Memorial Trail, reflect El Paso's desire to make bicycling a safe, convenient, and accessible choice for transportation and recreation. The City's traffic-calming program, the Neighborhood Traffic Management Program (NTMP) has helped to reduce travel speeds and make neighborhood streets safer for all road users, including bicyclists and pedestrians. The launch of the SunCycle Bike Share system in and around Downtown El Paso demonstrates the region's commitment to increasing transportation choices for area residents, employees, and visitors. Even with these improvements to the built environment, many roadways throughout the City are still intimidating to bicyclists and present significant challenges to residents and visitors that bicycle for transportation, or would like to bicycle, but are too intimidated by wide thoroughfares, heavy traffic volumes, and high traffic speeds.

### Planning and Policy Context

The City of El Paso and its partners throughout the region have made great strides to advance bicycling as a viable mode of transportation. This progress is built on a foundation of transformative plans and policies, designed to increase active transportation and create a system that accommodates the diverse values, needs,

and aspirations of the community. Efforts to integrate bicycling into the transportation network go back as far as 1977, culminating in 1982, when the City of El Paso developed its first Comprehensive Bikeway Plan. Since this first concerted effort to develop a bicycle transportation system, numerous local and regional plans have been developed that extoll the benefits of bicycling and offer actions and strategies to increase bicycling activity, such as the *Regional Bikeways Plan* (1997) and *SmartCode Bicycle Module* (2012). While early plans focused more explicitly on building bike lanes, bike routes and trails, more recent plans focus on a holistic approach to supporting active transportation. These recent plans include elements such as smart growth, mixed-use development, street design standards, bicycle parking, and education and encouragement programs, all of which are essential to creating a culture that supports bicycling. A complete review of existing plans and policies can be found in Appendix A, Existing Plans and Policies.

Two plans in particular, *Plan El Paso* (2012), the City's comprehensive plan, and the *Draft Great Streets and Corridor Plan* (2016), offer a solid foundation on which this Bicycle Plan effort can be developed. The ambitious goals of *Plan El Paso* emphasize bicycling as an integral component to the goal of becoming the least car-dependent city in the Southwest and connect alternative transportation to the long-term health, livability, and

# Map 1 EXISTING BIKEWAYS

## Legend

### Existing Bicycle Facilities

- Shared Lane Markings
- Wide Shoulder / Shoulder Bikeway
- Bike Lane
- Buffered Bike Lane
- Shared Use Path

### Other Features

- ★ SunCycle Bike Share Station
- Parks
- + City of El Paso

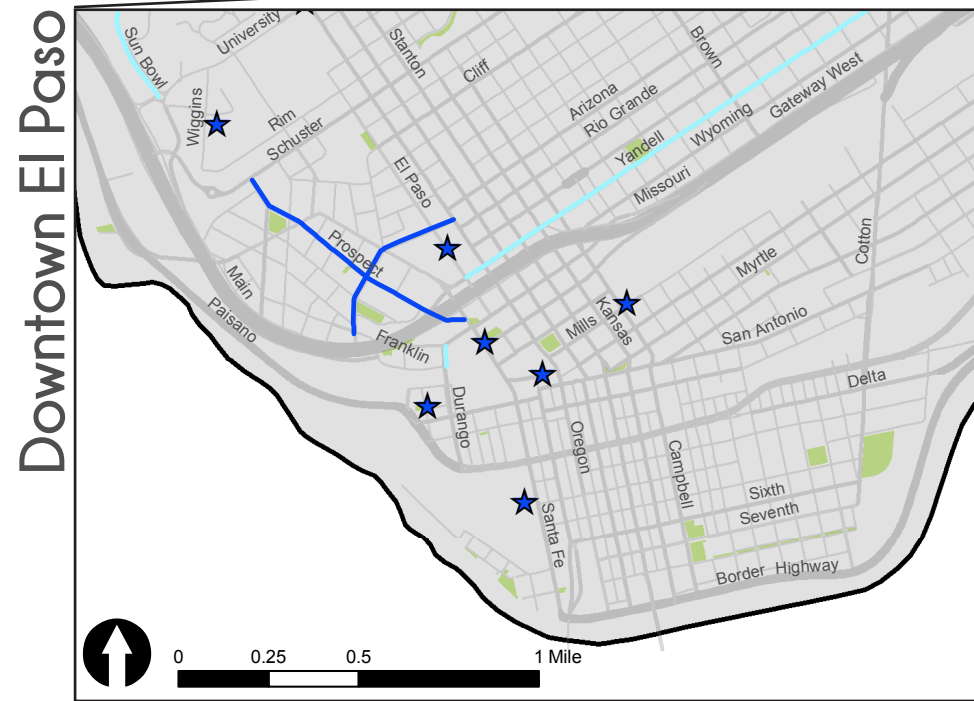
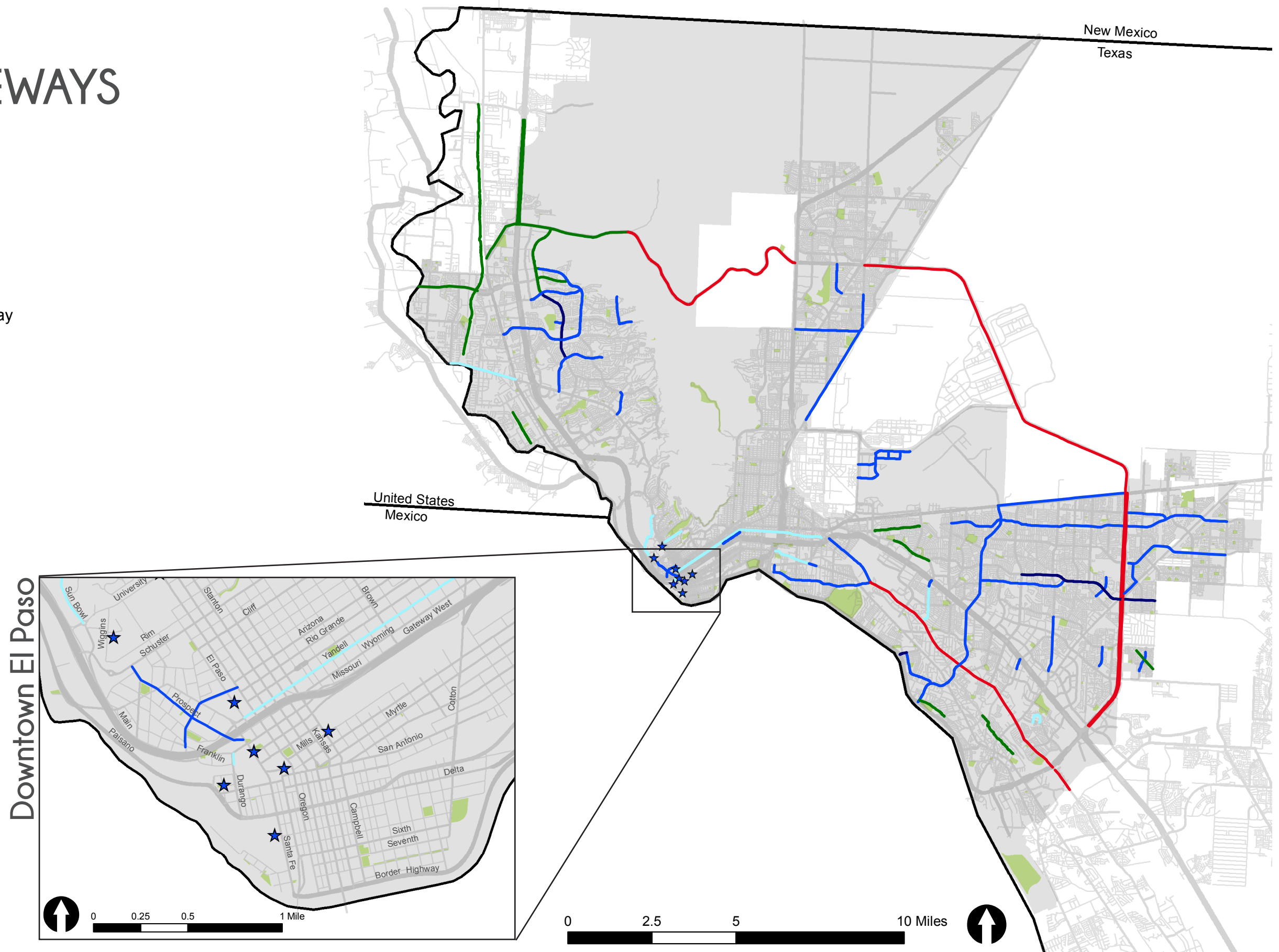

As of July 2016

economic vitality of the community. The *Great Streets and Corridor Plan*, which is a direct by-product of *Plan El Paso*, provides specific guidance for roadway design and integrating bicycle facilities into new and existing roadways of all shapes and sizes. The recommendations put forth in this Bicycle Plan build on these existing documents and further support the City’s efforts to reduce automobile dependency and position bicycling as a safe, convenient, and viable mode of transportation.

## The Bicycle Network

The City of El Paso’s bicycle network is growing. With over 100 miles of on-street bicycle facilities and over 30 miles of shared-use paths, the vision for an interconnected system of bike lanes and trails identified in previous planning efforts is beginning to take shape. The bicycle network consists of bike lanes, buffered bike lanes, shared travel lanes, wide shoulders, and shared-use paths, many of which are connected to one another and support travel between adjacent neighborhoods and commercial districts. Table 1 details the existing network mileage by facility type, and each facility type is described in greater detail later in this section of the plan. Map 1 shows the distribution of the existing network that is spread across the City, which is currently fragmented but offers great opportunities for connectivity in the future.

Even with the rapid growth in the bicycle network in recent years, there are still deficiencies that must be addressed moving forward. Three major deficiencies

**Table 1. Existing Bicycle Network by Facility Type**

Facility Type	Miles
Signed/Marked Bicycle Routes	11.5
Wide Shoulders	28.5
Bike Lanes	62.0
Buffered Bike Lanes	7.0
Shared-Use Paths (including Sidepaths)	30.6
Total	140

As of July 2016

limit the network’s utility for current bicyclists and deter potential bicyclists from bicycling on city streets. The first, and perhaps most significant based on feedback provided by El Pasoans throughout the planning process, is the lack of connectivity between the city’s main activity centers such as downtown and University of Texas-El Paso (UTEP) and the emerging Medical Center of the Americas. Bicycle facility installation is often dependent on scheduled capital improvements. New bike lanes are often developed independently from the existing network, and transitions between projects are not provided or explained to the public who use or live near these facilities.

The second shortcoming is the lack of low-stress facilities that accommodate less experienced bicyclists. Many bicycle facilities are located along busier arterial and collector roadways characterized by higher vehicle speeds and greater motor vehicle volumes, both of which can intimidate and deter less experienced bicyclists. By identifying routes along local roadways, neighborhood streets, and off-street paths, the City can open the bicycle network to accommodate a wider range of bicyclists.

The third major deficiency in the existing bicycle network is the lack of pavement markings leading up to and through intersections along existing bikeways, such as along Montwood, Yarborough, or Paseo del Norte. Intersection gaps like these are present along most corridors with bike lanes. These gaps create confused interaction between motorists and bicyclists, who must merge with motor vehicle traffic and navigate across signalized intersections with multiple turning movements. By extending bike lanes through the intersection approach and the intersection itself, the City of El Paso can more clearly indicate the appropriate, safe, and direct path for bicyclists. These intersection signing and markings can increase motorist awareness for bicyclists, highlight conflict areas between bicyclists and turning motorists, and encourage safe bicyclist lane positioning and positive interaction with motor vehicles.

Refer to Chapter 4, Network Analysis and Methods, for more information regarding locations of potential bicycling demand.

## Existing Bicycle Facilities

The existing bicycle network is composed of a variety of facility types. These facility types are described below, along with current mileage and a brief description of the quality and characteristics of some representative facilities for each type.

### Signed/Marked Bicycle Routes

Signed/marked bicycle routes use marking signage, wayfinding signage, and/or shared lane markings to guide people on bicycles along low-speed, low-volume roadways. Bicycle routes are often used to provide a low-speed alternative to a bicycle lane and fill short gaps in the bicycle transportation network. There are currently 11.5 miles of shared lane markings throughout El Paso. Examples of roadways with shared lane markings include Hunter Drive in Mission Valley, Sun Bowl Drive next to the University of Texas at El Paso, and Yandell Drive through Central El Paso. Conditions and quality of the shared lane markings vary throughout the city, as some markings on busier roadways are harder to maintain than others on less traveled roadways.

### Wide Shoulders

Wide paved shoulders are common bicycle facilities on many state and county highways throughout Texas and much of the Southwest, and El Paso is no exception. On rural highways, paved shoulders offer a suitable facility for many of the area's recreational road bicyclists, who enjoy the open roads around the perimeter of El Paso. Wide paved shoulders also offer benefits too, like providing space for disabled vehicles, reducing passing conflicts between motor vehicles and bicyclists and pedestrians, providing structural support to the pavement, and adding recovery area to regain control of a vehicle. TxDOT has added wide shoulders to numerous highways in El Paso, including Loop 375 (Transmountain Highway, Purple Heart Memorial Freeway, Joe Battle Boulevard) and North Loop Drive.

There are a total of 28.5 miles of wide shoulders in the City of El Paso, with an additional 20.6 miles immediately outside the City on Loop 375. Many area residents have expressed their concern with the conditions along

many of these wide paved shoulders, including varying shoulder widths and pavement quality, the presence of debris, high travel speeds of adjacent vehicles, and occasional disruptions and missing segments. The issue of through bicycle travel at interchanges and intersections is another key concern.



*Figure 1. El Paso features 28.5 miles of wide paved shoulders within city limits. Additional paved shoulders exist just outside El Paso.*

### Bicycle Lanes

Bicycle lanes designate an exclusive space for bicyclists through the use of pavement markings and signage. Bicycle lanes are located adjacent to motor vehicle travel lanes and are intended for use in the same direction as motor vehicle traffic. Bicycle lanes are typically on the right side of the street, between the adjacent travel lane and curb, road edge, or parking lane. Many bicyclists, particularly less experienced riders, would only consider riding on a busy street if it had a striped and signed bikeway and would avoid streets if they were expected to share a lane with vehicles.

The City of El Paso has made significant investments in bicycle lanes in recent years. The 62 miles of bicycle lanes throughout El Paso demonstrate the City's commitment to supporting bicycling as a viable transportation mode. Many of these projects have been completed in conjunction with regularly scheduled repaving and capital improvements or as a part of new roadway projects. As the City continues to build the bicycle network, addressing network gaps will maximize the value of these existing facilities.



Generally, the quality and character of existing bicycle lanes are acceptable, although there are some design and maintenance issues that must be addressed to provide a consistent level of quality that supports a safe, predictable, and comfortable bicycling experience. These issues include infrequent sweeping and removal of debris from bike lanes, “dropped” bicycle lanes at busier intersections (in which the bicycle lane ends at the intersection approach and resumes on the far side of the intersection), door zone encroachment, narrow bicycle lane widths, and fading striping and markings.



Figure 2. The city features 62 miles of bicycle lanes.



Figure 3. Another example of existing bike lanes in El Paso

## Buffered Bicycle Lanes

Buffered bicycle lanes are conventional bicycle lanes paired with a designated buffer space, creating more separation of the bicycle lane from the adjacent motor vehicle travel lane and/or parking lane. This treatment is appropriate on roadways with high motor vehicle traffic volumes and speeds, high volumes of truck or oversized vehicle traffic, and with adjacent on-street parking. Buffered bike lanes are also implemented as an effective use of space on a roadway for logical interaction between motor vehicles and bicyclists.

The City of El Paso recently added 4 miles of buffered bicycle lanes to Montwood Drive from Lee Trevino Drive to Shreya Street. As the first buffered bicycle lane in the City, the Montwood Drive buffered bicycle lanes signify a shift in the City’s approach to bicycle facility development, with a greater focus on separation, comfort, and user experience. Issues raised by area bicyclists for this project are similar to those raised about bicycle lanes in El Paso, particularly the need for more regular sweeping and for greater consideration for bicyclists approaching and traveling through signalized intersections.



Figure 4. A buffered bike lane on Montwood Drive (Imagery ©2016 Google)

## Shared Use Paths

A shared-use path (also called a trail, sidepath, or greenway) allows for two-way, off-street bicycle use and also may be used by pedestrians, skaters, wheelchair users, joggers and other non-motorized users. These facilities are frequently found in parks, along rivers and beaches, and in greenbelts or utility corridors where there

are few conflicts with motorized vehicles. Shared-use paths can also be located adjacent to roadways, but additional care and design considerations must be followed in order to minimize conflicts between path users and motorized vehicles. Shared-use paths can also include amenities such as lighting, signage, and fencing (where appropriate).

Existing shared-use paths in El Paso showcase the area's rugged natural beauty and provide a diversity of unique recreation and transportation experiences for bicyclists, joggers, hikers, and other trail users<sup>1</sup>. These paths include the Pat O'Rourke Memorial Trail, the Rio Grande Trail, the Pueblo Viejo Linear Trail, and the Mesa Drain Trail. TxDOT recently installed shared-use paths adjacent to Desert North and Desert South outer roads, providing additional trail connectivity in northwestern El Paso. Additional shared-use paths are being constructed along River Bend, Independence, and Viscount. Some of

<sup>1</sup> The City of El Paso's "Trails and Trailheads" brochure is available online: <https://www.elpasotexas.gov/~media/files/coep/parks%20and%20recreation/trailmap-brochure.ashx>



Figure 5. Example of shared-use paths in El Paso



Figure 6. Example of shared-use paths in El Paso

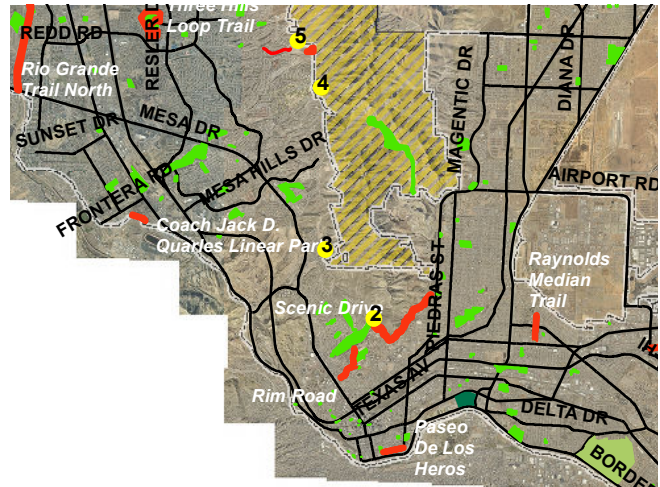

Figure 7. This cropped image from the City of El Paso's Trails and Trailheads brochure shows the location of selected trails within El Paso.

these trails, like the Pueblo Viejo Trail, are located within city-owned linear parks. Others, like the Pat O'Rourke Memorial Trail, Paseo del Norte, and Northwestern are located adjacent to arterial and collector roadways.

With limited connectivity to other bicycle facilities and to surrounding destinations, many of these paths serve only recreational purposes. Prioritizing new trail and bikeway development to connect with these existing facilities can increase their utility as part of a larger non-motorized transportation system. The Edgemere Median Trail has posted signs at each entrance, specifically showing no bicycles allowed.

### Mountain Bike Trails

Mountain bike trails offer El Pasoans a unique recreational opportunity to experience the region's diverse terrain and rugged, natural beauty. While not part of the bicycle transportation network, mountain bike trails are integral to El Paso's bicycling culture. With over 50 miles of trails in and around the City, people of all bicycling skill levels, from beginner to expert, can enjoy some of the finest mountain biking in Texas and the Southwest. Trails in Arroyo Park and Franklin Mountains State Park are popular mountain biking destinations year round. The Texas Parks and Wildlife Department offers a monthly Guided Beginner's Mountain Bike Ride that begins at Chuck Heinrich Memorial Park and takes riders on a 5 to 6 mile journey through the Franklin Mountains.



## Bicycle Facility Selection

Bicycle facilities in El Paso will vary based on existing roadway characteristics like width, travel speeds, and traffic volumes. For low-speed neighborhood roadways, shared facilities like signed or marked bike routes and bicycle boulevards (which include traffic-calming elements) provide speed and traffic management, as well as the appropriate visual cues to guide bicyclists to their destinations. For higher-speed roadways that carry more vehicles, greater separation between bicyclists and motor vehicles can increase user comfort and provide a safer environment for all road users. Buffered bicycle lanes, cycle tracks, and even separated off-street paths are necessary to facilitate safe and comfortable bicycle travel on these higher-speed collector and arterial

roadways. Figure 10 displays a facility selection matrix, which can be used to determine the appropriate bicycle facility for various roadway contexts throughout the City of El Paso. Stakeholders have expressed dissatisfaction with the existing bicycle lanes along many arterial and collector roadways. A facility selection matrix can help ensure that these high-speed, high-volume roadways feature greater separation between motor vehicles and bicycles. The facility selection matrix helps planners by offering contextual guidance for various roadway infrastructure tools. The chart's two design inputs are average annual daily traffic (AADT) and posted speed limit. Subsequent chapters of the plan will discuss facility selection and network planning in greater detail.

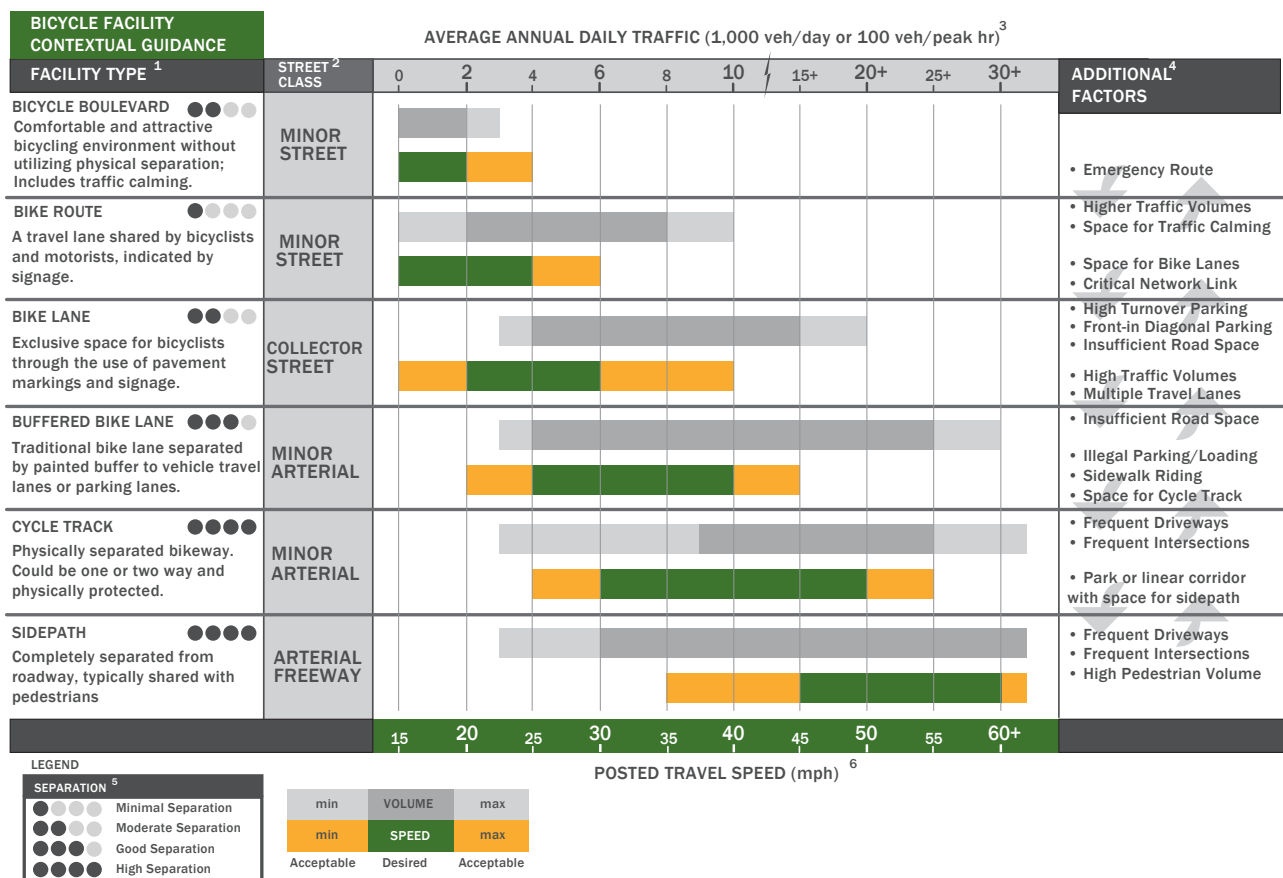

Figure 8. Bicycle Facility Selection Matrix (Sources: FHWA. Separated Bike Lane Planning and Design Guide. 2015. AASHTO. Guide for the Development of Bicycle Facilities. 2012. FHWA. Manual on Uniform Traffic Control Devices. 2009. NACTO. Urban Bikeway Design Guide. 2012. NCHRP Report 766: Recommended Bicycle Lane Widths for Various Roadway Characteristics. 2014)

## Programs and Partner Organizations

When it comes to creating a culture for bicycling, the City of El Paso must do more than just build and maintain bicycle-friendly streets. Numerous departments, including Capital Improvement, the Office of Resilience + Sustainability, Streets and Maintenance, Parks and Recreation Department, SunMetro Transit, and Planning and Inspections all must work together on supportive actions for bicycling in El Paso. From hosting bike workshops for city residents to providing online resources and information, the City will need to enhance efforts encourage bicycling for both recreation and transportation.

### Online Bike Information Resources

The City's Bike Information webpage serves as a valuable resource for bicycling related information and events throughout town. The page includes encouraging reasons to choose bicycling, tips for safe cycling, information about the SunCycle Bike Share program, links to area advocacy organizations and bicycle clubs, and other important bicycle-related information. (<https://www.elpasotexas.gov/ors/get-involved/bike-information>)

### Employee Bike Pool

Started in 2012 to encourage City employees to use alternative transportation and reduce on-the-job vehicle miles traveled, the City of El Paso has a pool of fourteen bicycles. This pool is likely to be moved due the downtown bike share.

### Capital Improvement Department

The City of El Paso's Capital Improvement Department (CID) plays a vital role in developing plans that incorporate and prioritize bicycle mobility, creating policies and design standards to build complete streets and monitoring plan implementation to meet broad-based community goals for transportation investments. The department's recent efforts, including City Council adoption of the NACTO urban street and bikeway design guides, the Great Streets and Corridor Plan (when adopted), in-house bicycle facility design, and numerous bikeway projects implemented throughout the city, are

a testament to El Paso's commitment to transform the built environment and integrate bicycling as a valued mode of transportation for El Pasoans.

### Neighborhood Traffic Management Program

The City of El Paso's Neighborhood Traffic Management Program (NTMP) is designed to evaluate and address traffic concerns in neighborhoods throughout the City. The existing program has minimal funding. The program uses common traffic-calming tools like traffic circles, roundabouts, curb extensions, bulb outs, medians, chokers and speed cushions to reduce motor vehicle speeds and create safer, more enjoyable streets for bicyclists and pedestrians. Kerbey Avenue and the Franklin Hills neighborhood have featured the installation of bicycle facilities. Additionally, more than 250 traffic-calming installations have been added to local streets as part of the NTMP. Some of the streets that have benefited from traffic-calming installations may be ideal corridors for the bicycle network. The following list identifies a selection of the residential streets that have applied and qualified for NTMP traffic-calming funding:

- Pino Real
- Mobile
- Robert Wynn
- Deer
- Hueco Valley
- Francis Scobee
- Vista De Oro
- Fiesta

### SunMetro Bike+Ride

SunMetro, the regional transit provider, promotes Bike+Ride, their slogan for combining bicycling and transit, which can greatly expand the range of bicycle trips. All fixed-route buses are equipped with a front-loading bicycle rack that holds two bicycles. Articulated buses, which serve some fixed routes, and Brio, the Rapid Transit System (RTS) route, along Mesa Street—with planned future route expansions along Alameda Avenue, Dyer Street, and Montana Avenue—come equipped with a three-bicycle rack on each bus. The agency has a webpage devoted to Bike+Ride, complete with information and an instructional video to help bicyclists load and



Figure 9. Curb extensions used as a traffic-calming device on Pennsylvania Place and Trowbridge Drive (Source: ©2016 Nearmap.com)



Figure 10. SunMetro's website includes video instruction on the use of their bike racks (Source: SunMetro.net).

unload their bike from the rack.

### Supporting Organizations

Communities that value and embrace bicycling know that it takes more than just bike lanes and trails to get people out on bikes. Establishing a bike culture to become like many successful bicycle programs around the country requires a holistic approach guided by the Six Es – Education, Encouragement, Engineering, Enforcement, Evaluation (and Planning), and Equity. Originally developed by the League of American Bicyclists, the Six Es stress the importance of changing not just the built environment but also people's habits, attitudes, and perceptions about bicycling.

In El Paso, individuals, agencies, community groups, and other parties are working to make bicycling safe, accessible, convenient, and fun for people of all ages and abilities. This section documents current efforts by agencies and organizations throughout El Paso that are





Figure 11. A graphic illustrating the Six Es

focusing on one or more of the Six Es to weave bicycling into the fabric of the community.

#### Bicycle Advisory Committee

El Paso’s BAC was established through a City resolution dated May 20, 2014, entitled, “Resolution Establishing a BAC for the Purpose of Advising the City of El Paso on Matters Related to Bicycle Planning and Infrastructure.” The BAC plays a key role in this plan’s creation, including assisting with the existing conditions analysis through recommendations creation.

#### Borderland Mountain Bicycling Association

Borderland Mountain Bicycling Association is a local chapter for the International Mountain Bicycling Association that creates, enhances, and preserves mountain biking trails in the El Paso region. They host the annual El Paso Puzzler, an endurance mountain bike race. More information is available through: <https://www.imba.com/about>

#### El Paso Bicycle Club

The El Paso Bicycle Club is an established group of recreational road bicyclists that hosts weekly rides and occasional training and skills workshops to encourage more El Pasoans to get out and ride. In August 2015, the El Paso Bicycle Club partnered with the City of El Paso Parks and Recreation Department to provide a family cycling workshop for people of all ages and skill levels. This cover-all workshop included safety drills, skill building exercises, roadway rides, tips on purchasing the right bike, basic maintenance, and even health and nutrition tips.

#### E.P. Cyclists

E.P. Cyclists is a non-profit cycling organization with a recreation and fitness focus. The organization leads group rides for all levels of cyclists and occasionally provides safety and skills training classes. E.P. Cyclists hosts a number of road races a year and provides training for health and fitness.



*Figure 12. SunCycle operates an eight-station bike share program in downtown El Paso.*

### Franklin Mountain State Park, Texas Parks and Wildlife Department

Franklin Mountain State Park, housed within Texas Parks and Wildlife Department, leads beginner mountain bike rides and wildlife preservation educational tours on the state park trail system. More information is available through: <http://tpwd.texas.gov/state-parks/franklin-mountains>

### Rio Grande Sierra Club El Paso

The Rio Grande Sierra Club El Paso encourages alternative transportation options for climate and wildlife preservation. More information available through: <http://www.riograndesierraclub.org/smarter-transportation-that-saves-wildlife/>

### SunCycle Bike Share

Launched in September 2015, SunCycle Bike Share is an eight-station bicycle share system designed to provide a convenient transportation option for short trips in and around the Downtown El Paso and UTEP area. The Camino Real Regional Mobility Authority developed the bike share system with financial support from the El Paso Metropolitan Planning Organization, the City of El Paso, the Texas Commission on Environmental Quality, and the UTEP Green Fund. Because the program is still in its infancy, data is not yet available to determine the efficacy of the program to decrease motor vehicle use and increase bicycling for short trips in the core of the City. Through various public engagement activities, El

Paso residents expressed their concern that, without supporting facilities like bicycle lanes, cycle tracks, and wayfinding signage, the bike share system will have a limited impact. The system is planning an expansion in 2016.

### The Franklin Mountains Wilderness Coalition

The Franklin Mountains Wilderness Coalition was formed in 1978. The organization played a central role in the formation of the Franklin Mountains State Park. The Coalition, according to materials found through their website, exists to encourage the recreational and educational use of the Franklin Mountains while preserving public lands. The Coalition sees mountain biking as important to improving quality of life and decreasing obesity and diabetes in El Paso. More information available through: <https://franklinmountains.wordpress.com/about/>

### VeloPaso

The VeloPaso Bicycle-Pedestrian Coalition works throughout the region to make bicycling and walking safe, easy, and economical forms of transportation and recreation for everyone. VeloPaso, often in collaboration with various partners throughout the region, leads numerous educational events, including safety training and bicycle skills courses, public awareness campaigns, organized bicycle rides for people of all ages and abilities, and biking and walking accessibility campaigns. In addition, VeloPaso has been a tireless advocate for bicycle and pedestrian-friendly infrastructure in El Paso, building support for policy, planning, and capital improvements that integrate non-motorized transportation.



## Opportunities and Constraints

The opportunities and constraints identified below represent key characteristics of El Paso that will guide project staff as they make recommendations for improved bicycling throughout the city.

### Opportunities

- Existing bicycle facilities offer a foundation on which a complete, interconnected network can be implemented.
- Pre-World War II development patterns, characterized by short block lengths and a gridded street pattern, provide numerous alternatives for bicycle facility development.
- Existing neighborhood traffic-calming installations can serve as building blocks for a bicycle boulevard network.
- The SunMetro transit system provides extensive coverage throughout the City and can be used by bicyclists to extend their trips and reach destinations beyond a comfortable bicycling range. A Brookings Institute study from 2012 found that public transit service covers 90.4 percent of the El Paso metropolitan area.
- Interconnected trails and sidepaths in Northwest El Paso are having a direct impact on bicycling activity and can form the basis for an off-street network that accommodates bicyclists of all ages, abilities, and comfort levels.
- TxDOT has been an active partner in the development of bicycle facilities, incorporating bike lanes and shared use paths into a number of recent and current roadway projects, such as Montana Avenue and Woodrow Bean Transmountain Drive (Loop 375).
- The City's many utility corridors, canals, and waterways may offer linear corridors for shared-use path development.

### Constraints

- Negative perceptions of difficult terrain and extreme weather

- El Paso's unique topography, particularly the Franklin Mountains, creates challenges for bicycling and limits potential routes for facility development.
- Interstate Highway 10, State Highway 54, and other limited access freeways act as barriers for bicycle travel with limited crossing opportunities, often on busier arterial and collector roadways.
- Suburban development patterns in Northwest, Northeast, and East El Paso force bicyclists to use arterial and collector roads to reach popular destinations.
- Most intersections of these arterials and collector roads are not designed with the cyclist in mind.
- Without direct connections to other bicycle facilities, many bike lanes in El Paso are underutilized and do not add value to the bicycle network.
- There are limited bicycle parking opportunities at most destinations.
- Maintenance of existing facilities, including sweeping debris out of bicycle lanes, isn't frequent enough for safe, reliable passage in some areas.
- Motorist and cyclist safety education
- Access to Bicycle Shops for all types of bike users and income levels
- Access to Community Bicycle Maintenance Facilities, build-a-bike program, example: City of Albuquerque's Esperanza Community Bicycle Shop, run by Albuquerque Parks and Recreation Department.
- Lack of bicycle parking amenities, and bike parking appropriately located in front of businesses and popular destinations
- Lack of Bicycle/Pedestrian Coordinator to ensure Bike Plan is followed.
- Lack of identified and/or dedicated funding for bike infrastructure.

## Section 4: Needs Analysis and Methods



## Needs Analysis and Methods

Making recommendations to improve the network requires both data and public input. This chapter includes an in-depth analysis of the roadway network. Data collected from existing conditions was evaluated to understand levels of traffic stress for bicycling, bicycle connectivity, and bicycle crash characteristics in El Paso. In order to understand users, the team held multiple public events to understand how El Pasoans currently bike, what infrastructure they require to support their bicycling needs, and what programs might encourage a bike-friendly culture in the City.

### Design Users

Bicyclists, by nature, are much more affected by poor facility design, construction and maintenance practices than motor vehicle drivers. Bicyclists lack the protection from the elements and roadway hazards provided by an automobile's structure and safety features.

It is important to consider bicyclists of all skill levels when planning and implementing bikeways. Bicycle infrastructure should accommodate as many user types as possible, with decisions for separate or parallel facilities based on providing a comfortable experience for the greatest number of people.

The current AASHTO Guide to the Development of Bicycle Facilities (2012) encourages designers to identify their rider type based on the trip purpose (Recreational vs. Transportation) and on the level of comfort and skill of the rider (Casual vs. Experienced).

### The Four Types of Bicyclists

A more detailed framework for understanding of the US population as a whole, not just existing bicyclists, was developed by planners in Portland, Oregon<sup>1</sup>, and supported by national research<sup>2</sup>. This classification provides the following alternative categories to address varying attitudes towards bicycling in the US:

#### Strong and Fearless:

Characterized by bicyclists that will typically ride anywhere regardless of roadway conditions or weather. These bicyclists can ride faster than other user types, prefer direct routes, and will typically choose roadway connections—even if shared with vehicles—over separate bicycle facilities such as shared-use paths.

#### Enthusied and Confident:

This user group encompasses bicyclists who are fairly comfortable riding on all types of bikeways but usually choose low-traffic streets or shared-use paths when available. These bicyclists may deviate from a more direct route in favor of a preferred facility type. This group includes all kinds of bicyclists—commuters, recreational riders, racers, and utilitarian riders.

#### Interested but Concerned:

This user type comprises the majority of the bicycling population and represents bicyclists who typically only ride on low-traffic streets or shared-use paths under favorable weather conditions. These users perceive significant barriers to their increased use of bicycling, specifically traffic and other safety issues, and may become “Enthusied and Confident” with encouragement, education, and experience.

#### No Way, No How:

People in this category are not bicyclists and perceive severe safety issues with riding in traffic. Some people in this group may eventually become more regular bicyclists with time and education. A significant portion of these people will not ride a bicycle under any circumstances.

1 Roger Geller, City of Portland Bureau of Transportation. *Four Types of Cyclists*. <http://www.portlandonline.com/transportation/index.cfm?&a=237507>. 2009.

2 Dill, J., McNeil, N. *Four Types of Cyclists? Testing a Typology to Better Understand Bicycling Behavior and Potential*. 2012.



Figure 13. Design users fall into four basic categories.

## Bicycle Suitability Index

The Bicycle Suitability Index (BSI) model incorporates infrastructure and demographic data in a Geographic Information System (GIS) to develop a snapshot of existing demand for and supply of bicycle facilities in El Paso. These analytical tools provide an objective, data-driven process of identifying network gaps, opportunities for new facility development, and areas of demand for bicycling activity and supporting facilities.

Two tools formed the basis for this analysis:

- Bicycle Demand Analysis (demand) analyzes trip origins and destinations
- Bicycle Level of Traffic Stress (supply) analyzes what physical on-street infrastructure currently exists

The resulting Supply and Demand Typologies Model presents an array of potential bicycle and improvement opportunities for El Paso. These data-driven tools complement the more subjective input received during public input sessions and through survey and online mapping. Both are critical components to developing a well-rounded network planning effort.

Models serve as an effective means to understand how factors in a complex system interact by providing a simplified version of the system for study. However, by definition, models are representations of reality and are constrained by the quality of available data and the complexity of the system under consideration. Throughout the modeling process, significant effort was made to collect the best data possible for input to the model and field-verify data as necessary and possible. Table 2 lists the data sources used for the BSI analysis.

The results of the modeling can be seen on Maps 2 through 8 and are explained in detail below.

**Table 2. Bicycle Suitability Index Data Sources**

Model Input	Source	Notes
Demographic Data	US Census	2010 Census Block Level Data
School Locations and Enrollment	City of El Paso	GIS Data
Parks	City of El Paso	GIS Data
Recreation and Senior Centers	City of El Paso	GIS Data
Museums	City of El Paso	GIS Data
Libraries	City of El Paso	GIS Data
Transit Service	City of El Paso	GIS Data
SunCycle Bike Share Locations	City of El Paso	GIS Data
Bicycle Facilities	City of El Paso, TxDOT	GIS Data
Traffic Signals	City of El Paso	GIS Data
On-Street Parking	City of El Paso, Aerial Imagery	GIS Data
Posted Speed Limit	City of El Paso	GIS Data
Number of Travel Lanes	City of El Paso	GIS Data

## Bicycle Demand Analysis

### Background, Overview, and Use Considerations

The Bicycle Demand Analysis provides a general understanding of expected bicycling activity by combining individual spatial analysis representative of where people live, work, play, access public transit and go to school into a composite sketch of demand for bicycle facilities throughout El Paso.

In general, the scoring method is a function of density and proximity. Scores reflect relative impact on walking or bicycling to and from census block corners that are located adjacent to the features used in the analysis. As such, scores are represented as density patterns of

census block corners within a 1/4 mile of each other. Subsequently, the scores are effectively a result of two complementary forces:

- Distance decay – the effect of distance on spatial interactions yields lower scores for features over 1/4 mile away from other features; and
- Spatial density – the effect of closely clustered features yields higher scores.

Scores will increase in high feature density areas and if those features are close together. Scores will decrease in low feature density areas and if features are further apart. In essence, the score is the intersection of distance and density. Thus, on the demand maps accompanying this plan, the highest density/usage/activity locations (shown in red) do not represent specific physical facilities, but rather represent relative higher use zones as calculated.

Categories are scored on a scale of 1 (low) to 5 (high) based on density and proximity and then assigned weighted multipliers to reflect the relative influence categories have on bicycle activity.

### Bicycle Demand Analysis Results

Where people live includes 2010 decennial census block level population information. These locations represent potential trip origin locations. The specific threshold for active transportation-supportive residential density varies by community. As a general rule, more trips can be made in areas with higher population density. El Paso’s population is dispersed quite evenly across the city, with higher concentrations of residential populations in certain areas in the East, Northeast, and Northwest planning areas. In East El Paso, densely populated neighborhoods along Vista Del Sol, George Dieter, Edgemere, and Pebble Hills have significant potential to generate bicycle trips. Similar neighborhoods exist along Belvidere, High Ridge, and Resler in the Northwest; Roanoke and McCombs in the Northeast; and Dyer, Alabama, and Arizona in Central El Paso.

Where people work mainly represents trip destinations for people working in El Paso, regardless of residency. This data layer is based on 2010 total employment by census



Map 2

# BICYCLE FACILITY DEMAND: LIVE

## Legend

Demand

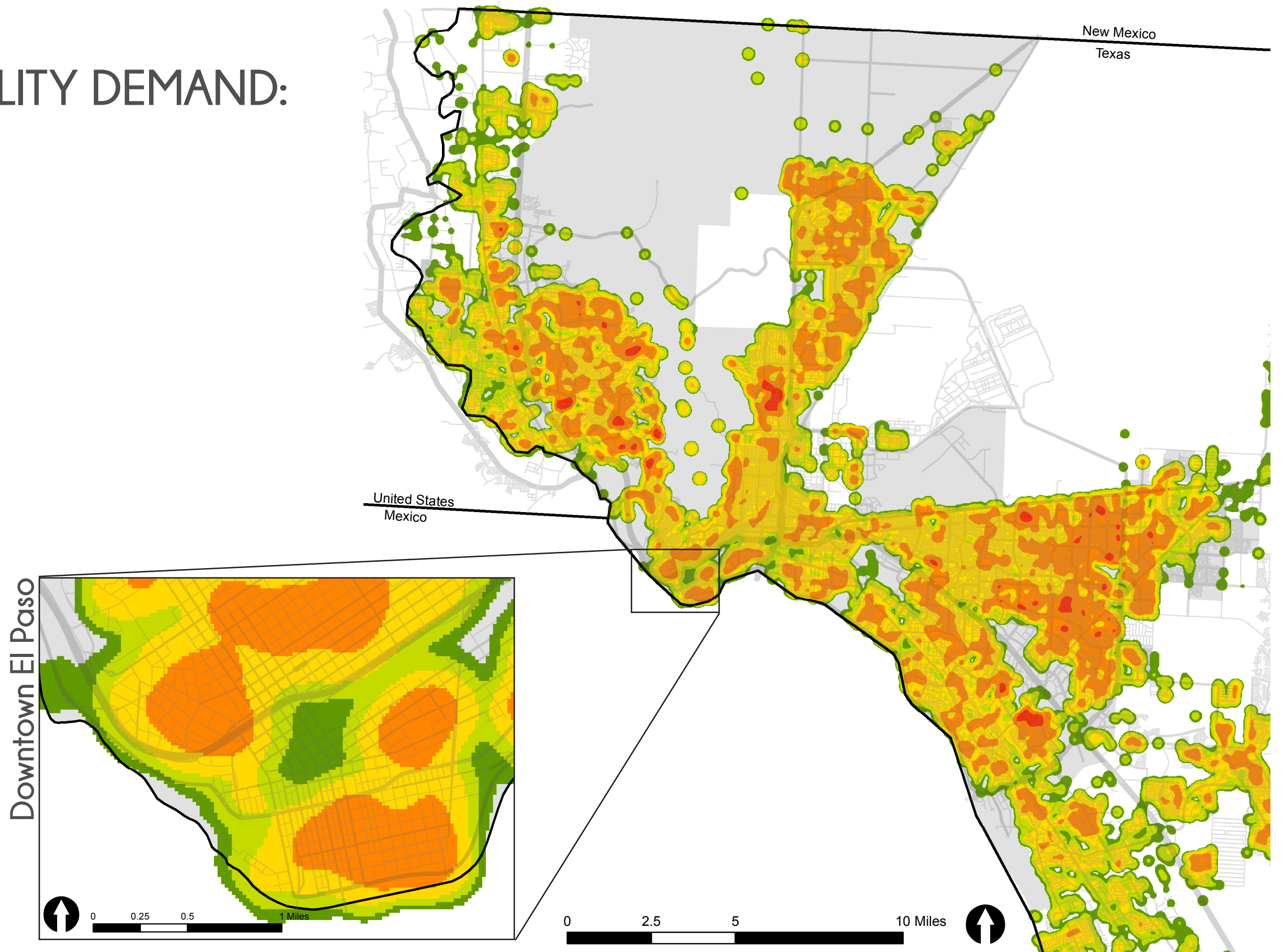

Map 3  
**BICYCLE FACILITY DEMAND:  
WORK**

Legend

Demand

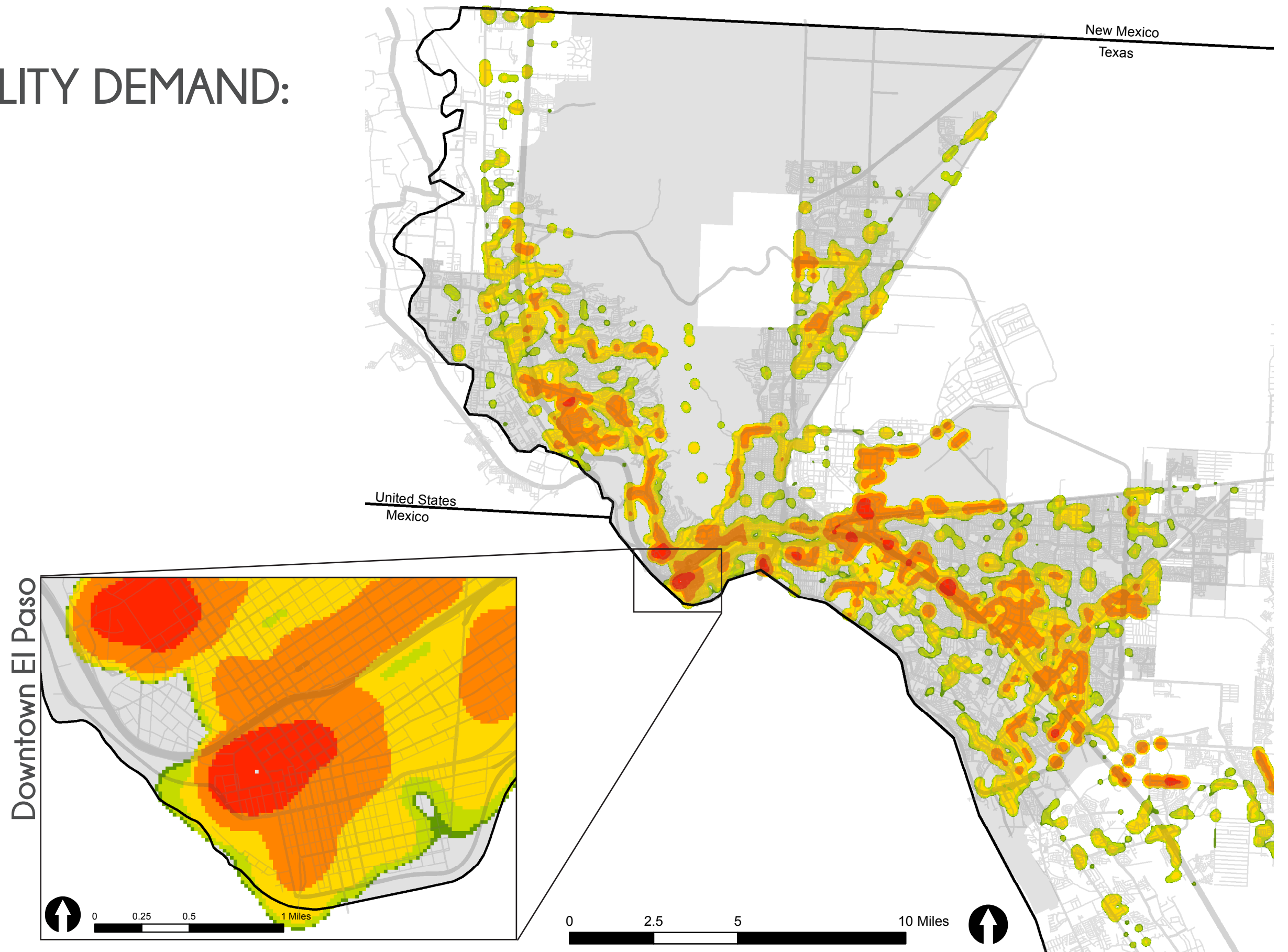



Map 4

# BICYCLE FACILITY DEMAND: LEARN-PRIMARY/SECONDARY

## Legend

### Demand

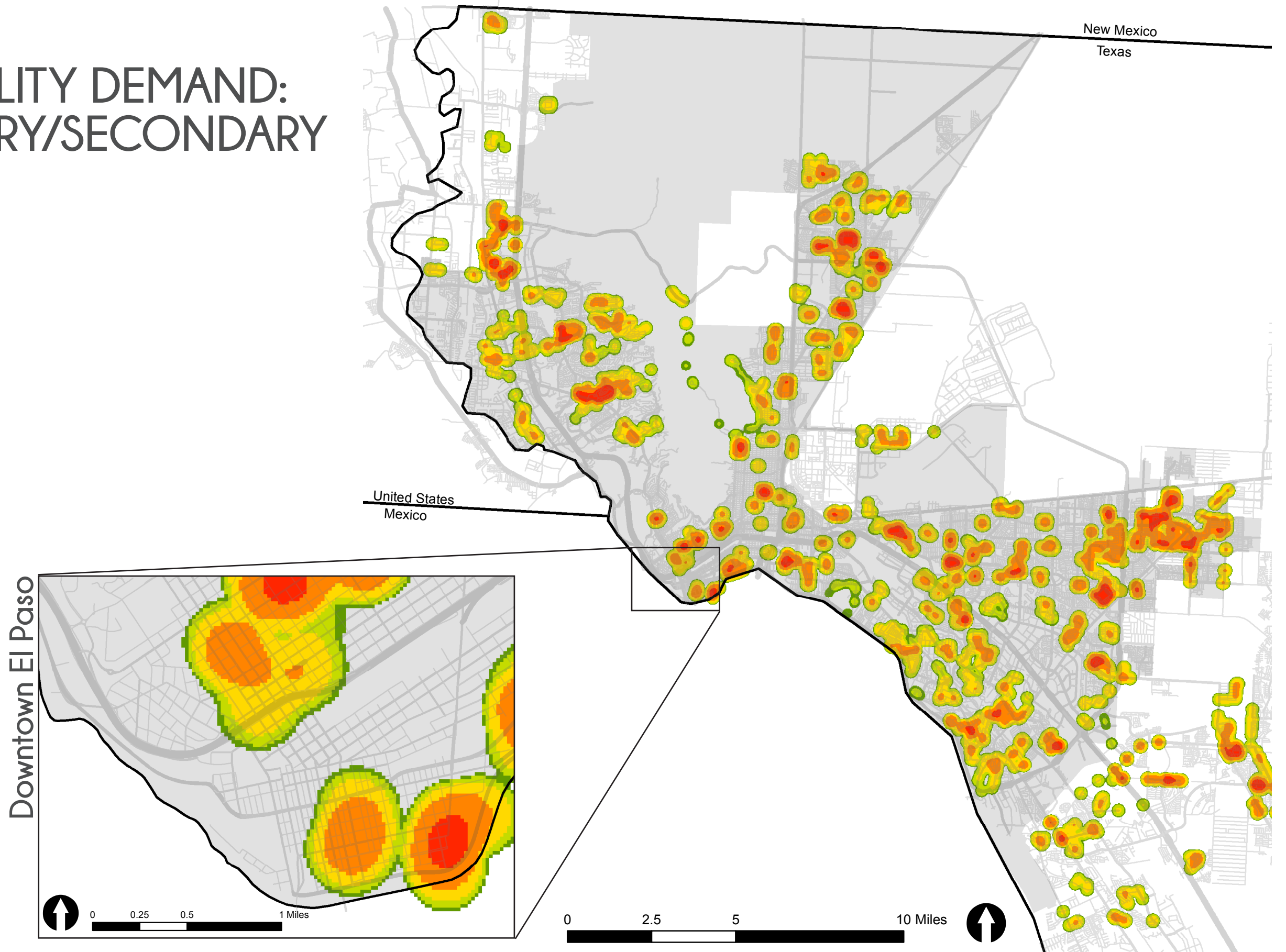

Map 5

# BICYCLE FACILITY DEMAND: LEARN-COLLEGE/UNIVERSITY

## Legend

### Demand

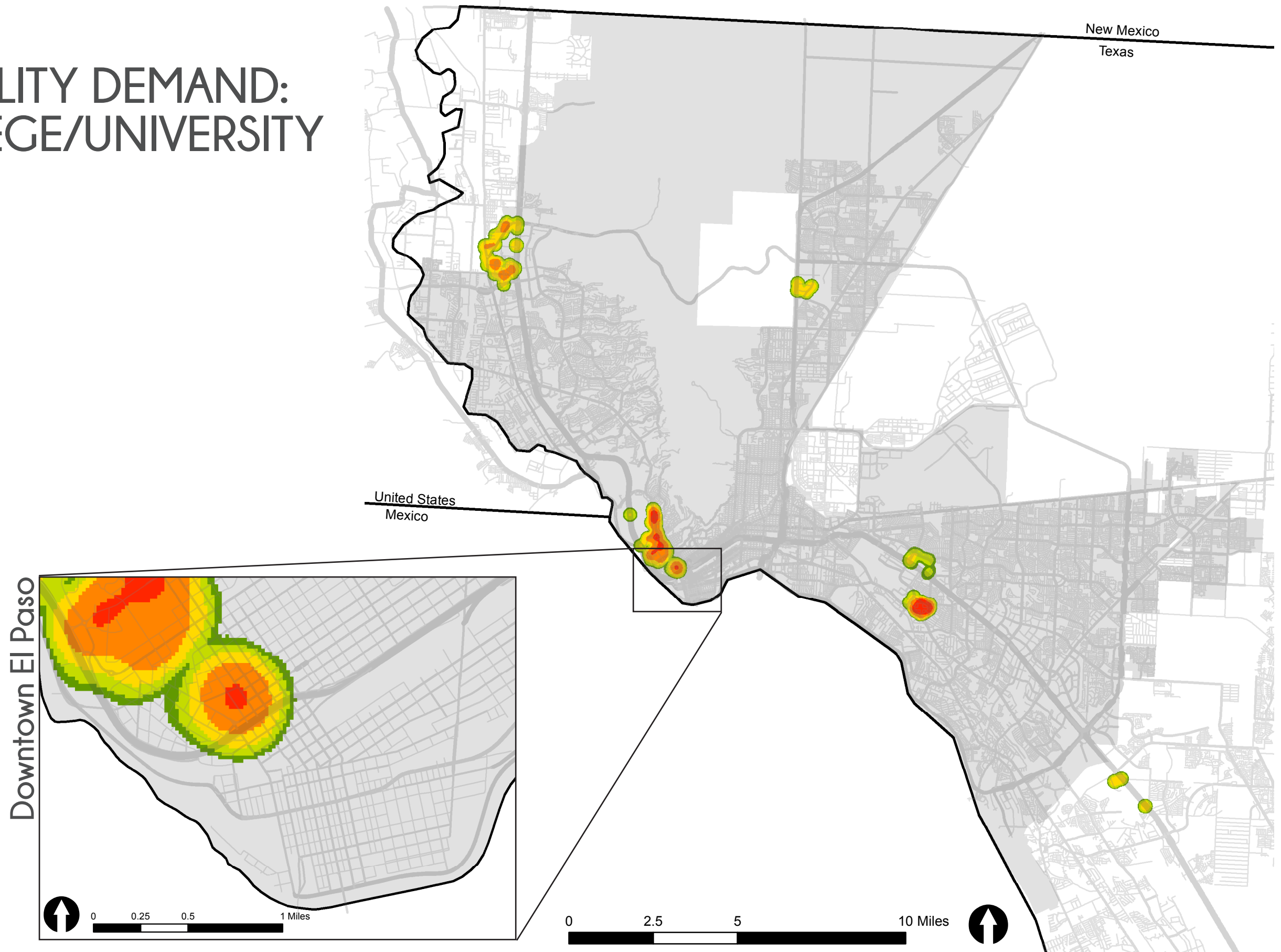



Map 6

# BICYCLE FACILITY DEMAND: PLAY

## Legend

Demand

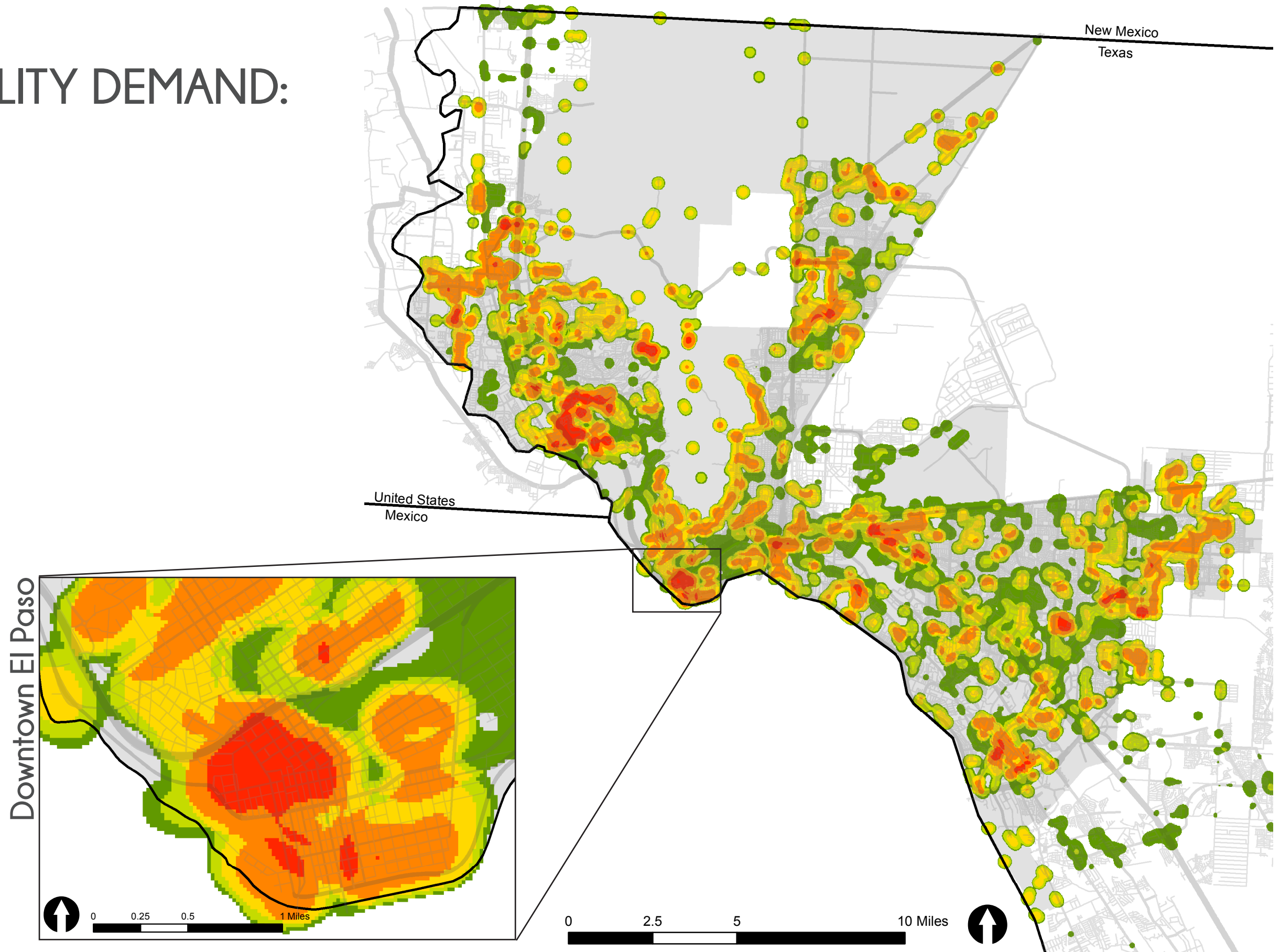



Map 7

# BICYCLE FACILITY DEMAND: TRANSIT

## Legend

Demand

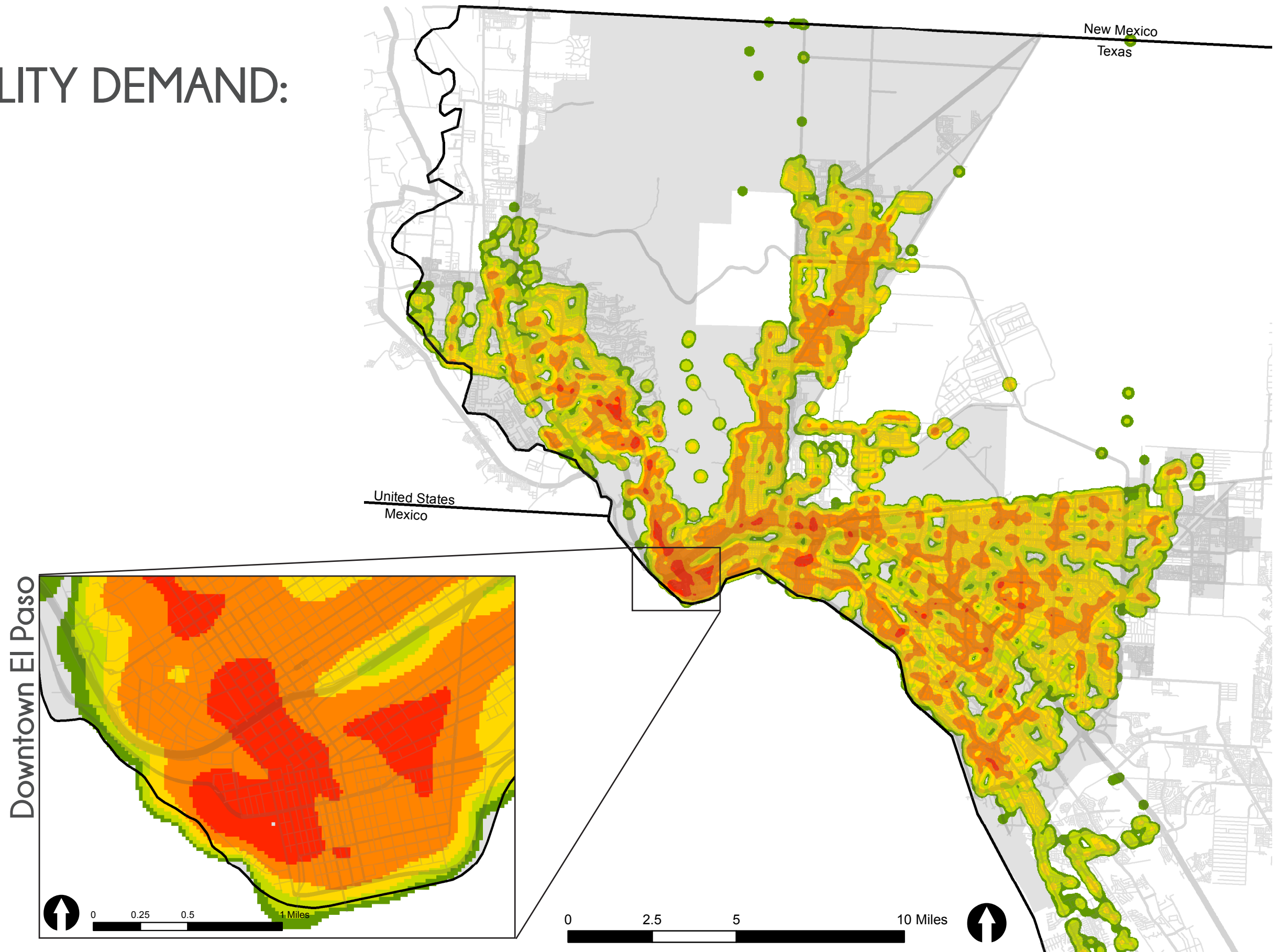
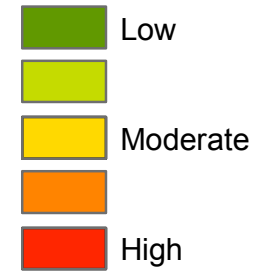

Map 8

# BICYCLE FACILITY DEMAND: COMPOSITE

## Legend

Composite Demand

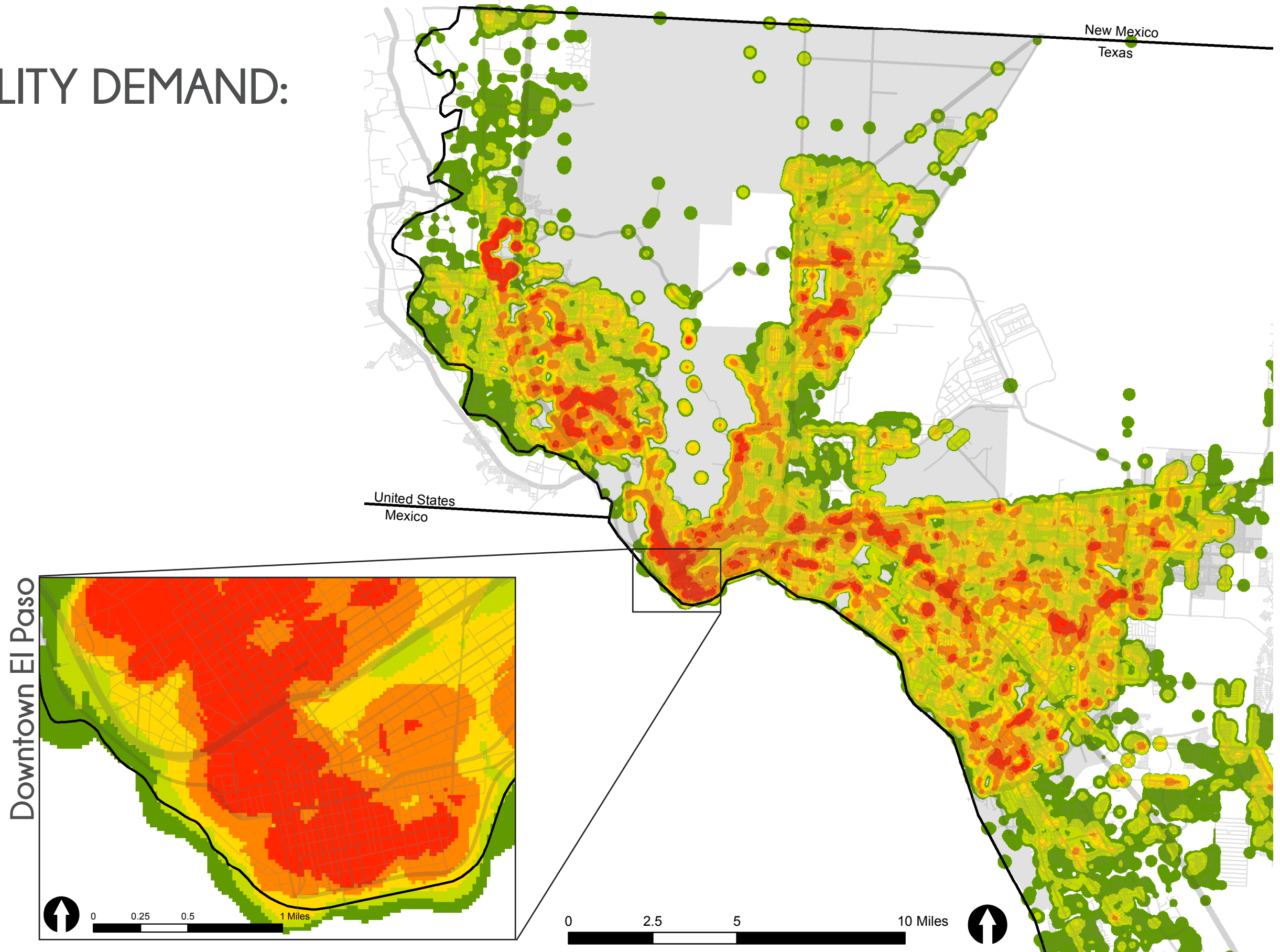



block. Depending on the type of job, this category can represent both trip attractors, like retail stores and cafes, and trip generators, like office parks and office buildings. Hot spots for the “work” analysis include Downtown El Paso, UTEP, Hospitals of Providence Memorial Campus, University Medical Center, El Paso International Airport and surrounding area, Bridge of the Americas Port of Entry, and numerous commercial destinations along Interstate Highway 10 through East El Paso.

Where people learn represents where students K-12, at community college, or at university go to school. Its basis is enrollment data provided by the City of El Paso, and obtained directly from districts and institutions. This becomes the student-age resident equivalent of a work trip generator. University and K-12 models were split to allow for K-12 visual clarity due to relatively large enrollment at the university and community college. K-12 schools are distributed across the entire city and generally mirror residential population distribution. University and community college demand is more concentrated, with the greatest demand at schools with the highest populations, namely University of Texas-El Paso (UTEP), El Paso Community College (EPCC)-Valle Verde Campus, and EPCC–Northwest Campus.

Where people play is a combination of varied land use types and destinations. Overlays such as retail destinations, parks, linear trails like the Rio Grande Trail, senior centers, recreation centers, libraries, and museums contribute to this category. While all destinations are not exactly where one would expect to “play,” these civic amenities are still destinations of importance reflected in this category due to the temporary nature of the visit. Much like schools and other neighborhood amenities, many of the “play” hotspots are scattered throughout El Paso. Significant hotspots include the Rio Grande Trail and the Westside Sports Complex in the Northwest; Downtown El Paso and its numerous cultural institutions, Memorial Park, Lincoln Park, and Ascarate Park in Central El Paso; Pueblo Viejo and Blackie Chesher Parks in Mission Valley; Edgemere Median Trail, the future Eastside Regional Park, and commercial destinations along the Interstate Highway 10 corridor and surrounding

the 375 Loop and Zaragoza intersection in East El Paso; and McKelligon Canyon Park, Northeast Regional Park, and Veterans Park, in Northeast El Paso.

Where people access transit is assessed by location of SunMetro bus stops, Brio rapid transit stops, and SunCycle Bike Share stops. Moreover, a 2012 Brookings Institute study found that public transit covers 90.4 percent of El Paso’s metropolitan area.<sup>3</sup> Transit hotspots generally follow Brio and SunMetro bus routes, e.g., Sun Metro Express bus stops and bus routes, and are especially pronounced in areas where routes intersect and overlap. Downtown, UTEP, University Medical Center, Five Points, the Mesa corridor, and the Alameda corridor represent some of the highest demand areas based on access to transit. By improving bicycle access to these transit hotspots, the city can effectively increase bicyclists’ ability to travel longer distances access destinations outside their traditional bicycling range.

Composite Demand is determined by overlaying the factor maps and applying standard weights to each factor. This composite demand analysis shows that the areas of El Paso with the highest potential for bicycle travel demand are dispersed in clusters throughout the city, often surrounding land uses that generate high volumes of trips, bicycle or otherwise. The main findings are presented below, according to planning area:

- In Central El Paso, these high demand areas are most contiguous and cover UTEP, near UTEP, Downtown El Paso, and parts of the Sunset Heights, Houston Park, and Golden Hills neighborhoods.
- In Northwest El Paso, high demand areas include Mesa between Interstate Highway 10 and Mesa Hills, EPCC–Northwest Campus, Westside Sports Complex, and the numerous shared use paths along Spur 16, Resler, and Woodrow Bean Transmountain.

---

<sup>3</sup> Tomer, Adie. *Where the jobs are: employer access to labor by transit*. 2012. Brookings Institute. Available through: <http://www.brookings.edu/research/papers/2012/07/11-transit-jobs-tomer>

- In the Northeast, the varied amenities and strong residential bases of the Castner Heights, Irvin, and Tobin Mount neighborhoods combine to drive a high demand for bicycle facilities. Farther north, commercial activity at the Fairbanks and Rushing intersection and the surrounding neighborhoods also create a high potential for bicycling.
- In East El Paso, demand is highest at commercial nodes along major arterial and collector roadways. The Airway/Viscount corridor, stretching from Montana to Interstate 10, represents one of the largest contiguous high-demand areas outside of Central El Paso. Other high-demand clusters are located at Zaragoza and Loop 375, McRae and Interstate Highway 10, and George Dieter and Vista del Sol.
- In Mission Valley, composite demand for bicycle facilities is highest at EPCC-Valle Verde Campus, Ascarate Park and the surrounding area, the Zaragoza and North Loop intersection, and along Alameda between Zaragoza and Loop 375.

## Bicycle Level of Traffic Stress

The Bicycle Level of Traffic Stress (BLTS) analysis provides objective, data-driven scores of roadway comfort for bicycle travel that are used to recognize gaps in the bicycle network and aid in the identification of projects that can enhance network connectivity and provide a safe and comfortable bicycling experience for El Paso's diverse population of current and prospective bicycle riders. The analysis incorporates the recent research on factors that impact bicycle comfort and safety, and was tailored to the City of El Paso using the data available. The model analyzed the full roadway network within the City of El Paso, excluding limited access highways, to provide a full picture of connectivity, or lack of connectivity, for bicycling around the city.

The methods used for the BLTS analysis were adapted from the 2012 Mineta Transportation Institute (MTI) *Report 11-19: Low-Stress Bicycling and Network Connectivity*. The approach outlined in the MTI report uses roadway network data, including posted speed

limit, the number of travel lanes, and the presence and character of bicycle lanes, as a proxy for bicyclist comfort level. Road segments are classified into one of four levels of traffic stress based on these factors. The lowest level of traffic stress, LTS 1, is assigned to roads that would be tolerable for most children to ride, and also to multi-use paths that are separated from motorized traffic; LTS 2 roads are those that could be comfortably ridden by the mainstream adult population; LTS 3 is the level assigned to roads that would be acceptable to current "enthused and confident" bicyclists; and LTS 4 is assigned to segments that are only acceptable to "strong and fearless" bicyclists, who will tolerate riding on roadways with higher motorized traffic volumes and speeds. The definitions for each level of traffic stress are as follows<sup>4</sup>:

### LTS 1

Presenting little traffic stress and demanding little attention from bicyclists, and attractive enough for a relaxing bike ride. Suitable for almost all bicyclists, including children trained to safely cross intersections. On links, bicyclists are either physically separated from traffic, or are in an exclusive bicycling zone next to a slow traffic stream with no more than one lane per direction, or are on a shared road where they interact with only occasional motor vehicles (as opposed to a stream of traffic) with a low speed differential. Where bicyclists ride alongside a parking lane, they have ample operating space outside the zone into which car doors are opened. Intersections are easy to approach and cross

### LTS 2

Presenting little traffic stress and therefore suitable to most adult bicyclists but demanding more attention than might be expected from children. On links, bicyclists are either physically separated from traffic, or are in an exclusive bicycling zone next to a well-confined traffic stream with adequate clearance from a parking lane, or are on a shared road where they interact with only occasional motor vehicles (as opposed to a stream of traffic) with a low speed differential. Where a bike lane lies between a through lane and a right turn lane, it is configured to give bicyclists unambiguous priority where cars cross the bike

<sup>4</sup> Mineta Transportation Institute (MTI) Report 11-19: Low-Stress Bicycling and Network Connectivity

lane and to keep car speed in the right-turn lane comparable to bicycling speeds. Crossings are not difficult for most adults.

### LTS 3

More traffic stress than LTS 2, yet markedly less than the stress of integrating with multilane traffic, and therefore welcome to many people currently riding bikes in American cities. Offering bicyclists either an exclusive riding zone (lane) next to moderate-speed traffic or shared lanes on streets that are not multilane and have moderately low speed. Crossings may be longer or across higher-speed roads than allowed by LTS 2, but are still considered acceptably safe to most adult pedestrians.

### LTS 4

This is simply any level of stress beyond LTS 3.

## Methodology

The following data inputs were incorporated into the BLTS analysis. Table 3 displays each variable, its source, and notes on limitations of the available data and assumptions that were made.

Scoring in BLTS is based off of the four basic categories defined in the MTI report. This scoring methodology is summarized in Tables 4 and 5. The BLTS scoring decreases comfort (1 is the highest comfort level) as the number of lanes, posted speed limit, and traffic volumes increase. Traffic volumes reduce comfort more where bicyclists share the road with motorized vehicles, but comfort also decreases in bicycle lanes as traffic volumes next to those bicycle lanes increase.

Table 3. Sources of Model Inputs

Model Input	Source	Notes
Posted Speed Limit	City of El Paso Street Centerline Database	Not available for all streets.
Number of Travel Lanes	City of El Paso Street Centerline Database	Not available for all streets. Streets without data were assigned number of travel lanes using a combination of pavement width and functional classification.
Traffic Signals	City of El Paso	Where local roads meet collector or arterial roads, the local roads were assumed to be stop-controlled.
Bicycle Lanes	City of El Paso	

Unsignalized crossings increase stress for bicyclists along otherwise low-stress routes. An intersection level of service analysis was completed to identify difficult crossings. The results of the intersection analysis were then applied back to street segments approaching each intersection to reflect the quality of the intersection on each segment. Crossing comfort decreases as the number of lanes and posted speed increase. While median refuges can reduce the stress of an unsignalized crossing, refuges were not included in this analysis because of insufficient data.

## Analysis Results

### Segment Analysis

The results of the segment-based BLTS analysis are shown in Map 9. Much of the network consists of disconnected clusters of low-stress (LTS 1 to 2) streets, shown in green and yellow. These islands of low-stress, local neighborhood streets offer a safe and comfortable bicycling experience for nearly all adults and many older children. However, where neighborhood streets approach collector and arterial roadways, level of traffic stress increases for people riding bicycles. Larger arterial roadways provide a more stressful bicycling experience and function as barriers for bicycle travel, especially for less-experienced riders. These results align with El Pasoans' perceived safety risks regarding roadway character and quality for bicycling.

Table 4. Segment Scoring Matrix for Bicycle Level of Traffic Stress

Number of Travel Lanes	Speed Limit					
	Shared Street			Street with Bike Lane		
	≤ 25 mph	30 mph	≥ 35 mph	≤ 30 mph	35 mph	≥ 40 mph
2 lanes (residential)	1	2	4	1	3	4
2 - 3 lanes	2	3	4	2	3	4
4 - 5 lanes	3	4	4	3	3	4
6 or more lanes	4	4	4	4	4	4

1 = Highest Comfort Level

Table 5. Intersection Scoring Matrix for Bicycle Level of Traffic Stress

Number of Travel Lanes	Posted Speed Limit		
	≤ 30 mph	35 mph	≥ 40 mph
Up to 3 lanes	1	2	4
4-5 lanes	2	3	4
6+ lanes	3	4	4

1 = Highest Comfort Level

### Connectivity Analysis

While major roadways act as barriers at unsignalized crossings, signals provide a connection for bicyclists to move between low-stress neighborhood roadways. Map 10 displays connected clusters of roadways that can be travelled without using any link or crossing with a level of stress higher than 2. As the map displays, clusters of low-stress roadways are bound by major arterials, interstate highways, and even topographical constraints. These clusters are most evident in East El Paso, where the grid system of arterial and collector streets limits people’s ability to travel outside local neighborhoods. In Northeast El Paso, east-west arterial corridors and major closed land uses like Fort Bliss limit connectivity. Northwest El Paso is entirely disconnected from the rest of the city, as the only through roadways that offer a connection for bicyclists (Paisano Drive and Mesa Street) are high-stress roadways. This display makes apparent the gaps in the bicycle network that could be targeted for improvements to create connected bicycling routes that are comfortable for the mainstream adult population. Along with improvements along high-stress corridors, safe crossing opportunities across those corridors will greatly increase bicycling mobility.

### Conclusions

The bicycle level of stress analysis described in this plan provides a picture of the quality of infrastructure in the City of El Paso that serves people riding bicycles. The results show that, while many of the city’s streets offer low-stress environment for bicycling, arterial and collector roadways and other major barriers create challenges for people traveling by bicycle to school, to work, to transit, or for everyday daily trips. By identifying these clusters of low-stress streets for bicycling, the City of El Paso can better develop countermeasures and recommendations that increase safety, comfort, and connectivity, and in turn make bicycling a more accessible mode of transportation for El Pasoans.

### Collision and Safety Analysis

Safety for bicyclists of all ages and abilities is a key factor for improving bicycling conditions in El Paso. Although the rate of crashes involving bicycles in El Paso may not be high, concern about safety is a significant barrier to bicycling. Perceived safety risks can impact the number of bicycle trips made. A Safe Routes to School (SRTS) survey in 2004 found that 30 percent of parents consider traffic-related danger to be a barrier to allowing their



Map 9

# BICYCLE LEVEL OF TRAFFIC STRESS

## Legend

Bicycle Level of Travel Stress

- BLTS 1 (Lowest)
- BLTS 2
- BLTS 3
- BLTS 4 (Highest)

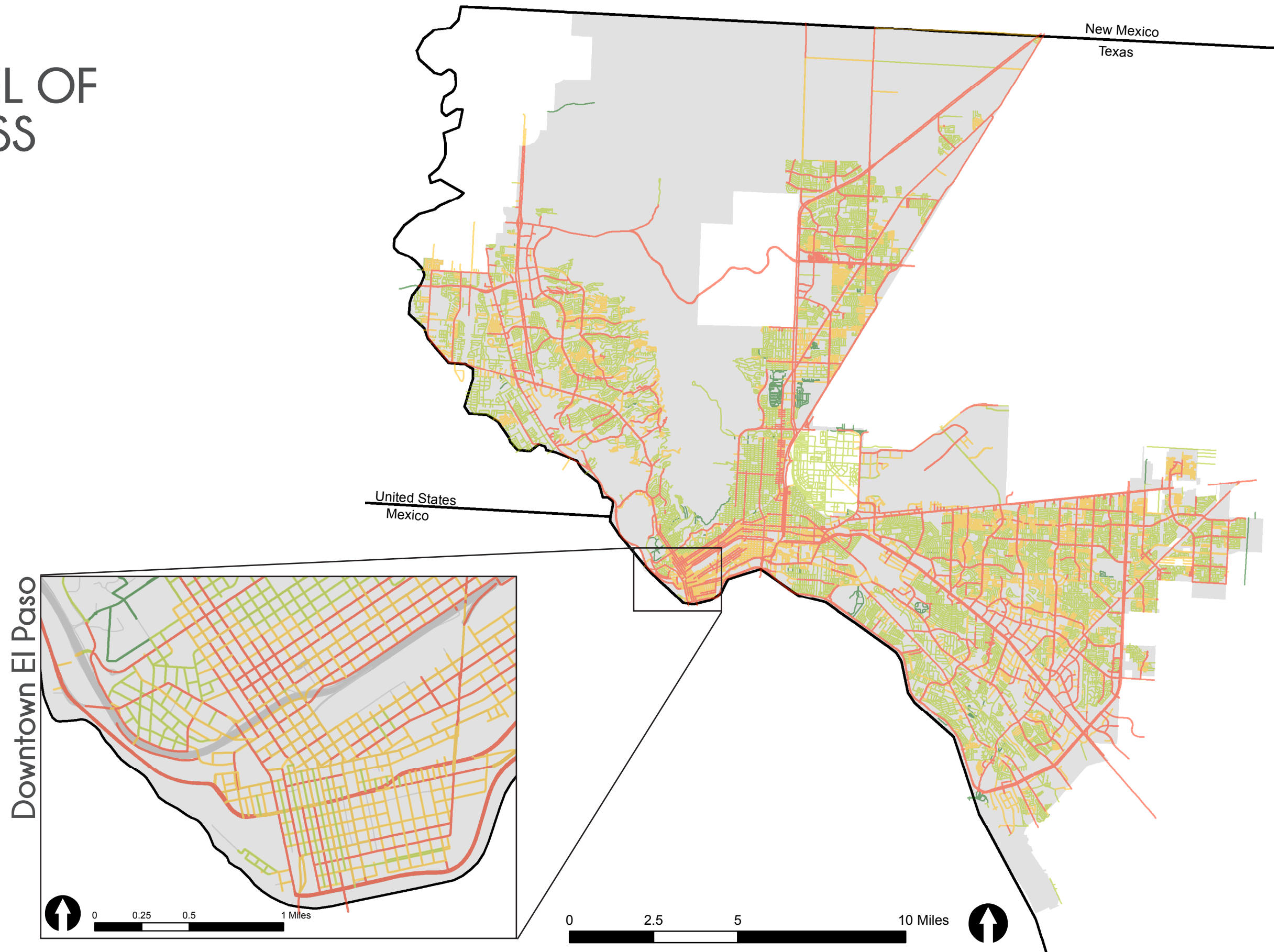

Map 10

# LOW-STRESS (BLTS 1 + BLTS 2) CONNECTIVITY CLUSTERS

## Legend

Existing Clusters

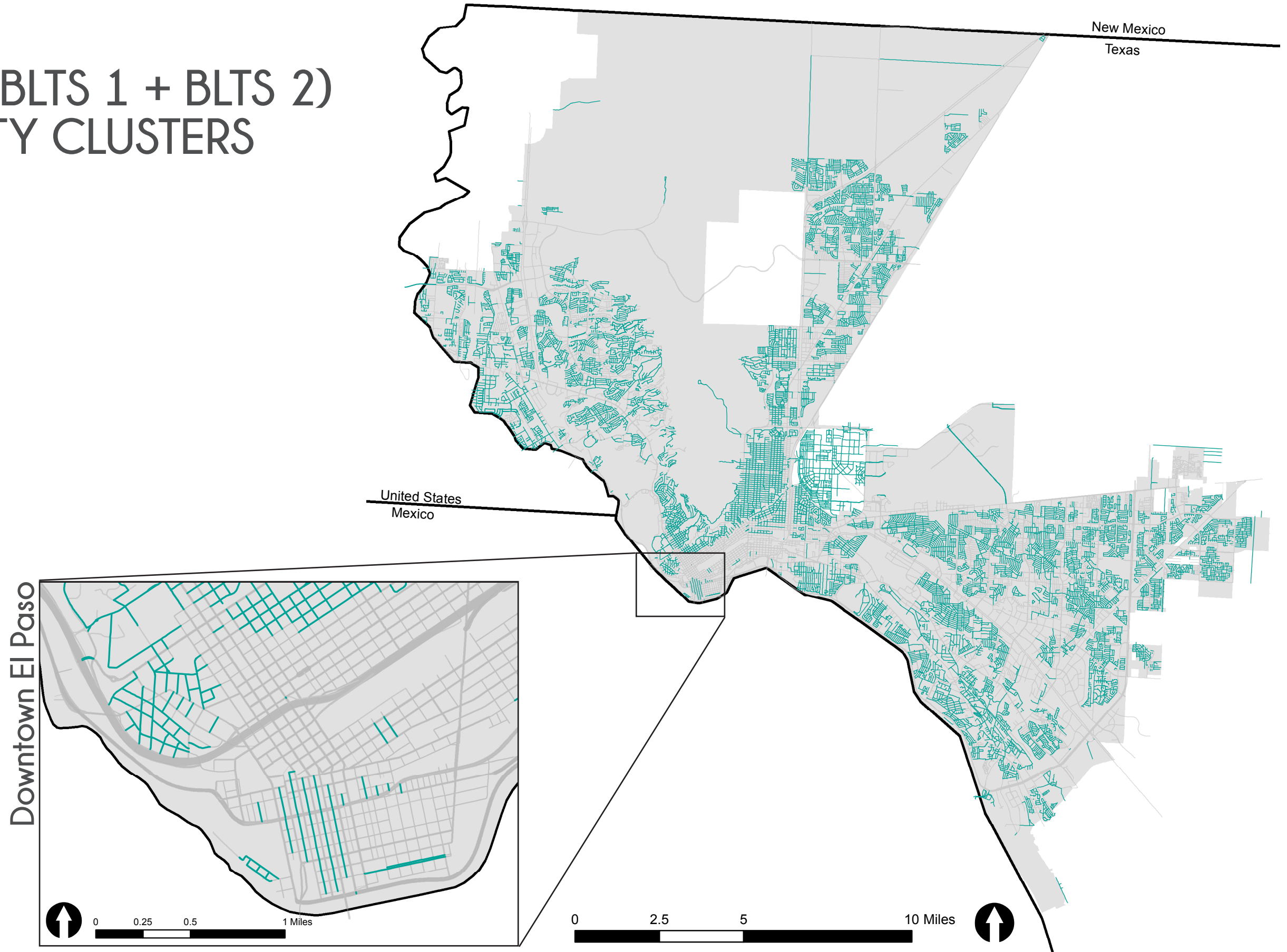

children to walk or bike to school.<sup>5</sup> Improving bicyclist safety is key to El Paso becoming the least car-dependent city in the Southwest and ultimately increase the number of people who use bicycles for transportation. Installation of protected bike lanes in New York City not only increased the number of bicyclists on city streets but also increased safety for and reduced injuries to all street users by 56 percent.<sup>6</sup>

Local traffic collision data can be a valuable source of information for identifying trends in bicycle and pedestrian crashes, understanding specific crash characteristics, and developing countermeasures to create a safer environment for non-motorized roadway users. In order to determine if any specific locations should be reviewed during the recommendations phase for safety improvements, existing crash data was reviewed and analyzed to identify potential crash patterns. Following is a description of the available crash data and discussion of patterns.

### Findings

The TxDOT El Paso District provided crash data from January 1, 2010, through December 17, 2015, nearly six full years of crash data. During this time, a total of 352 crashes involving bicycles occurred in the City of El Paso, with an average of fifty-nine crashes per year.<sup>7</sup> Data for each crash included location information, manner of crash, contributing factors, bicyclist information, severity of injuries, weather and lighting conditions at the time of the crash, and date and time.

### Injury Severity

Injuries often result from bicycle crashes, particularly those involving motor vehicles. Three hundred fifty-four cyclist injuries occurred as a result of the 352 crashes involving bicyclists, indicating that some crashes involved more than one bicyclist. Figure 14 displays bicycle crashes in El Paso by the severity of the bicyclist's injury.

Of those 354 resulting injuries, only one was fatal.<sup>8</sup> More than nine out of every ten crashes resulted in an injury or possible injury.

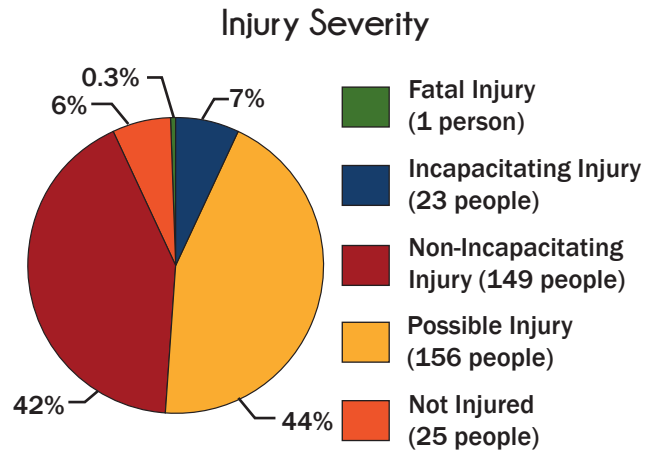

Figure 14. Percentage of crashes by injury severity

### Crash Locations

Map 11 shows the locations of all reported crashes in El Paso from 2010 through 2015. In the absence of bicycle count data, crash location data can provide insight regarding roadways commonly used by bicyclists, although it should not be taken as a direct substitute. The geographic distribution of bicycle collisions correlates to both population density and street network density. The highest concentrations of bicycle collisions are located in Downtown El Paso and the surrounding vicinity, where the traditional neighborhood street grid and a mixture of land uses encourage bicycle transportation. These crashes are distributed among local, collector, and arterial roadway types. Farther from the urban core, suburban development patterns limit local connectivity and impel bicyclists to ride on or cross higher-volume, higher-speed roadways. Crash data reflects this shift in bicyclists' route options, as the majority of bicycle crashes occur on arterials and collectors, including Montana Avenue, Yarbrough Drive, Montwood Drive, Mesa Street, and Alameda Avenue. Figure 15 displays the percent of crashes in each plan area during the 2010 to 2015 time period. Forty-three percent of all crashes occurred in Central El Paso, and an additional 24 percent occurred in East El Paso. The remaining crashes were distributed

5 US Centers for Disease Control and Prevention, *Barriers to Children Walking to or from School United States 2004, Morbidity and Mortality Weekly Report, September 30, 2005*. Available: [www.cdc.gov/mmwr/preview/mmwrhtml/mm5438a2.htm](http://www.cdc.gov/mmwr/preview/mmwrhtml/mm5438a2.htm).

6 NYC DOT, "Measuring the Street: New Metrics for 21st Century Streets", 2012. <http://www.nyc.gov/html/dot/downloads/pdf/2012-10-measuring-the-street.pdf>

7 TxDOT El Paso District crash data, 2010-2015.

8 The fatal crash occurred on August 22, 2013.

evenly among the Northwest, Northeast, and Mission Valley planning areas, with 11 percent in each.

Table 6 lists the ten roadways with the highest number of crashes from 2010 through 2015, including crashes at intersections along these corridors. The high number of crashes along Mesa Street validates residents' concerns about safety issues along this heavily traveled corridor

### Crashes by Plan Area

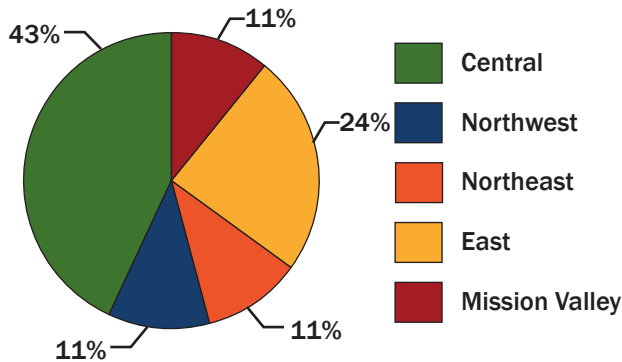

Figure 15. Percentage of crashes by plan area

Table 6. Roadways with the Highest Number of Crashes

Corridor	Number of Crashes (2010 - 2015)
Mesa	27
Paisano	16
Edgemere	15
Montana	13
Yarbrough	12
Alameda	10
Dyer	9
Montwood	9
Oregon	8
Stanton	8

Based on TxDOT data, 2010-2015

and the lack of suitable north-south alternatives between Central and Northwest El Paso.

### Crash Conditions

Figure 16 through Figure 18 show reported bicycle crashes by month, day of the week, and time of day. As shown in Figure 16, the greatest number of crashes was reported in spring and fall months, with the frequency of reported incidents peaking in May and again in October. This is consistent with observed patterns of bicycle use in El Paso and roughly coincides with the most pleasant weather during the course of the year as well as school schedules.

Figure 18 shows the frequency of reported crashes by day of the week. Crashes were most frequently reported on Tuesday and Thursday, while the fewest crashes were reported on Sunday and Wednesday. The higher crashes

### Crashes by Month

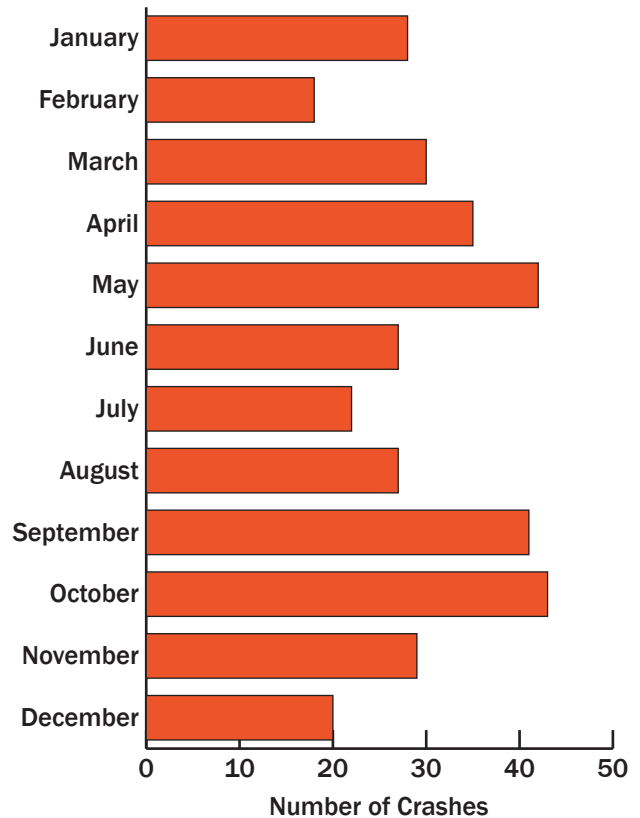

Figure 16. Number of crashes by day of month



## Crashes by Time of Day

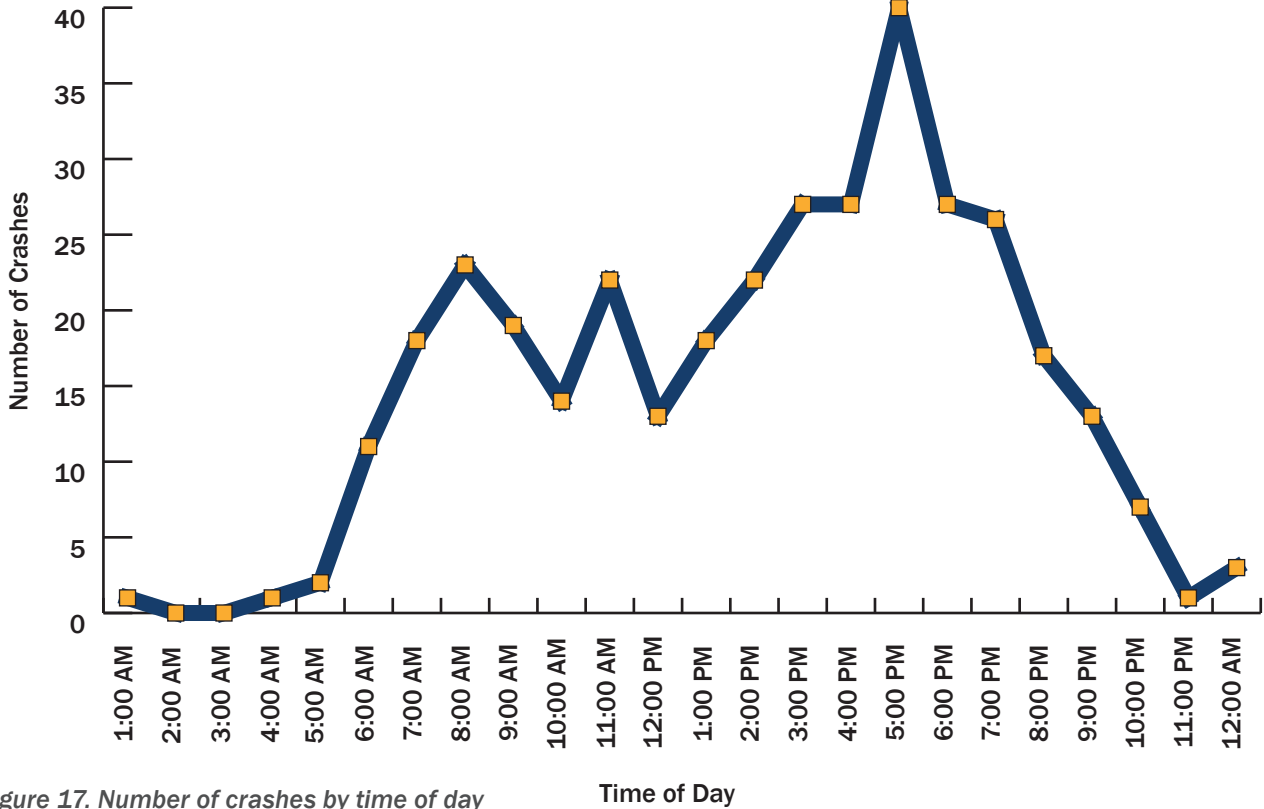

Figure 17. Number of crashes by time of day

## Crashes by Day of Week

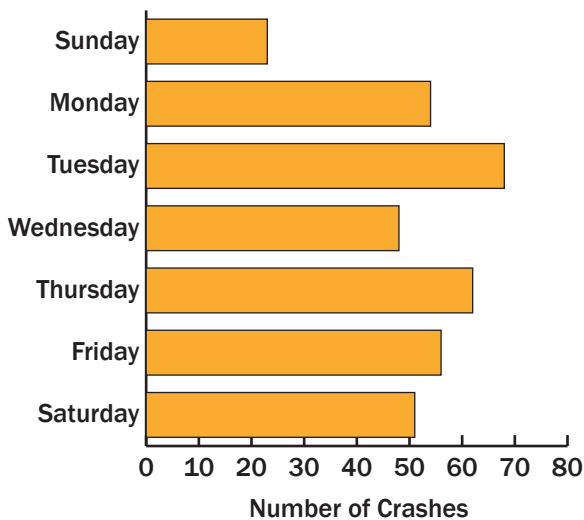

Figure 18. Number of crashes by day of week

per day on weekdays may suggest that more individuals are bicycling for commuting and utilitarian purposes. However, additional data obtained through a bicycle count program would be needed to determine travel patterns by day of the week and time of day.

The reported bicycle collisions occurred most frequently during the afternoon hours, peaking during the 5 PM hour and coinciding with rush hour traffic (Figure 17). More than one in every three bicycle crashes occurred between 3 PM and 7 PM. This late afternoon spike in reported crashes roughly correlates with the evening work commute, as well as children traveling home from school. There are also brief peaks in bicycle crashes during the morning rush hour (7 AM to 9 AM) and the lunch hour (12 PM).



Time of day doesn't always correspond directly to daylight hours, investigating officers also capture light conditions. Over 75 percent of all crashes occur in daylight conditions, compared to roughly 20 percent occurring at night. Of those crashes that occur at night, more than two thirds take place under lighted conditions from streetlights or adjacent land uses as shown in Figure 19.

### Crashes by Light Condition

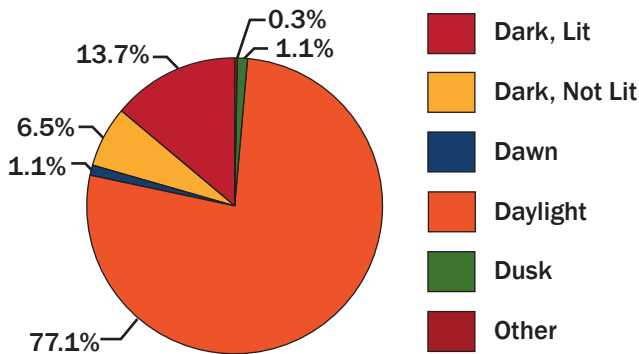

Figure 19. Percentage of crashes by light condition

Weather conditions had little impact on bicycle crashes during the period studied. Almost 97 percent of all crashes occurred under clear skies or clouds. Crashes in

### Crashes by Weather Conditions

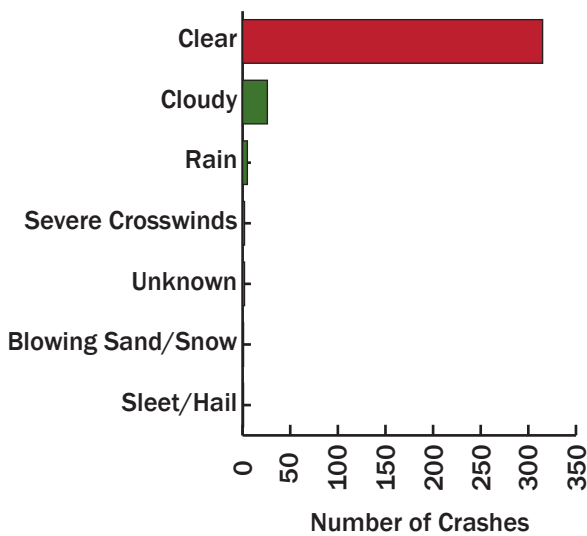

Figure 20. Number of crashes by weather conditions

rainy, windy, snowy, or otherwise severe conditions represent just 3 percent of all crashes as shown in Figure 20. This may reflect both climate and weather conditions in El Paso, one of the sunniest cities in Texas and the sixth sunniest city in the United States<sup>9</sup>, as well as many individuals' propensity to avoid bicycling during precipitation and extreme weather events.

### Crash Characteristics and Contributing Factors

More than two-thirds of all bicycle crashes occurred at intersections or were intersection related, and an additional 11 percent of bicycle crashes occurred at driveway access points. These figures are fairly consistent with data from other urban areas across the US, as a high number of turning movements creates a greater number and variety of potential conflict points. This data also suggests the importance of intersection treatments.

### Crashes by Location

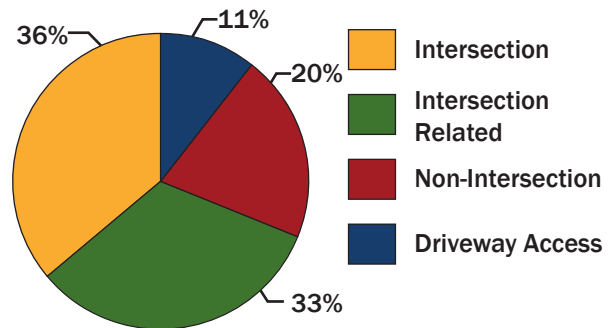

Figure 21. Percentage of crashes by location

Of more than 50 contributing factors from which a reporting officer can choose when detailing a crash, failure to yield right of way was the most frequently cited contributing factor of bicycle crashes, accounting for 28 percent. Other commonly cited primary causes included driver inattention (14 percent), and disregarding stop sign or light (5 percent), as shown in Figure 22. A number of contributing circumstances were recorded in less than 1 percent of crashes.

<sup>9</sup> Source: National Oceanic and Atmospheric Administration, *Extremes in US Climate*. <http://www.ncdc.noaa.gov/extremes/extreme-us-climates.php>, retrieved 2016.

## Crashes by Contributing Factor

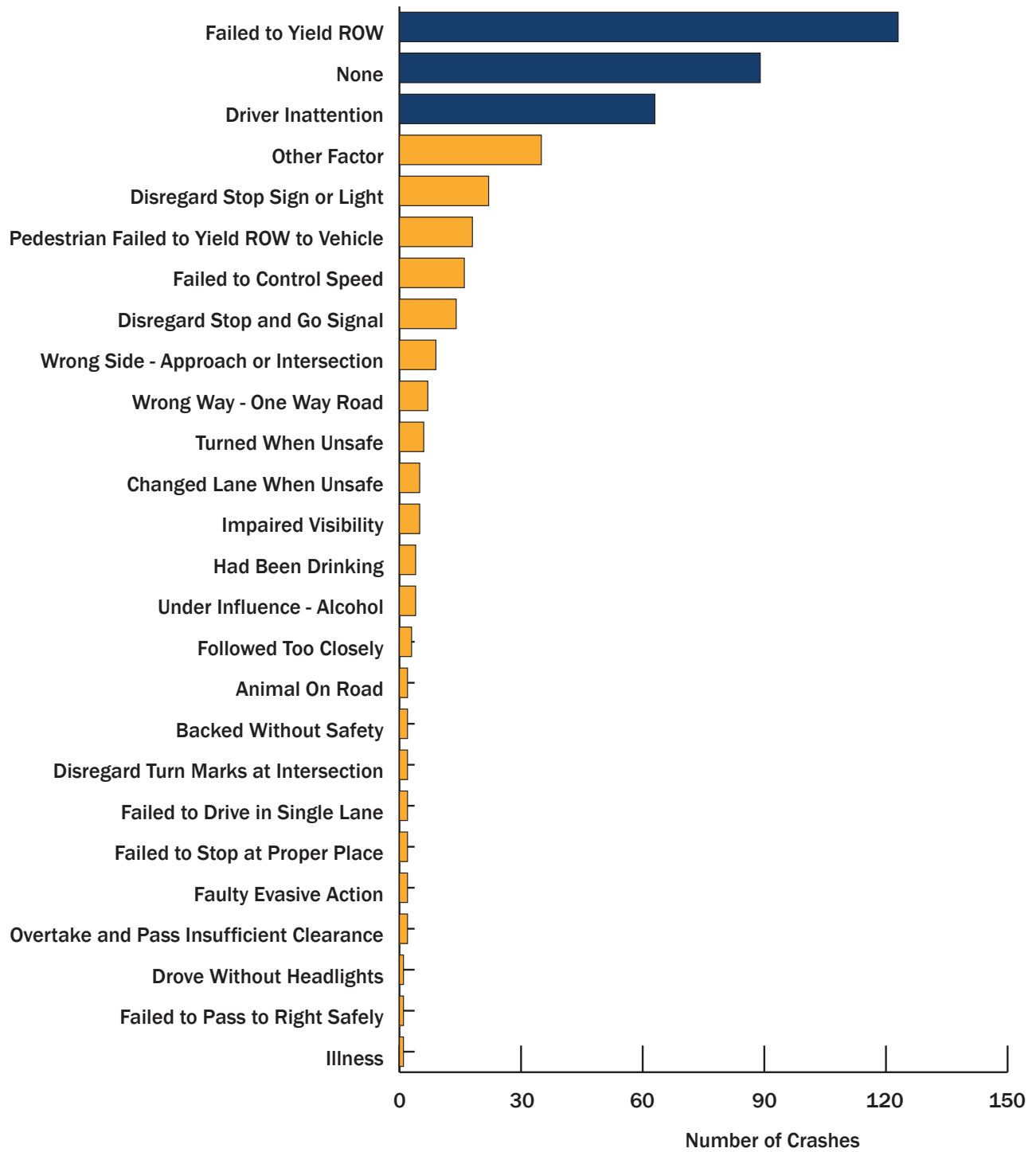

Figure 22. Number of crashes by contributing factor

While the responsible party is not identified in the data, some crash types can be more readily attributed to bicyclist behavior, such as left of center and wrong way on a one-way road. These behaviors can be reduced through targeted education classes and outreach campaigns that aim to provide bicyclists with the proper knowledge to safely and effectively travel on the road.

### Bicyclist Characteristics

Bicyclists involved in crashes reflect the community's diverse demographics. People of all ages and ethnicities ride bicycles, which the crash data reflects. Of the 354 bicyclists for whom gender data was collected for the crash report, an overwhelming percentage of bicyclists were male (87 percent male compared to 13 percent female). The age of bicyclists involved in reported crashes was widely distributed across the spectrum, from three to 86. As shown in Figure 23, more than one in every three El Pasoans involved in a crash while riding a bicycle was 20 years old or younger. The average age for female bicyclists involved in a crash was 26, compared to 33 for males.

Three in every four bicyclists involved in a crash were Hispanic. Caucasian El Pasoans accounted for 19 percent of all bicyclists involved in crashes, while African-Americans accounted for 5 percent and Asian-Americans accounted for less than 1 percent.

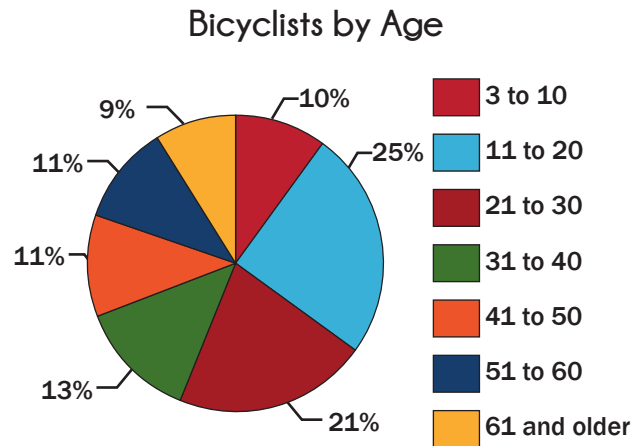

Figure 23. Percentage of bicyclists in crashes by age

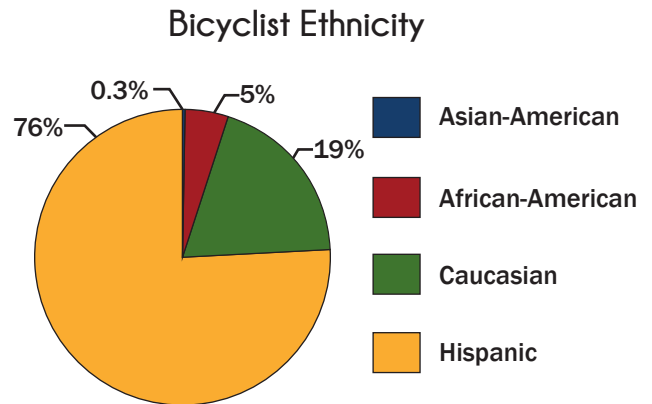

Figure 24. Percentage of bicyclists in crashes by ethnicity

Map 11

# BICYCLE CRASH LOCATIONS

## Legend

● Bicycle Crash Locations

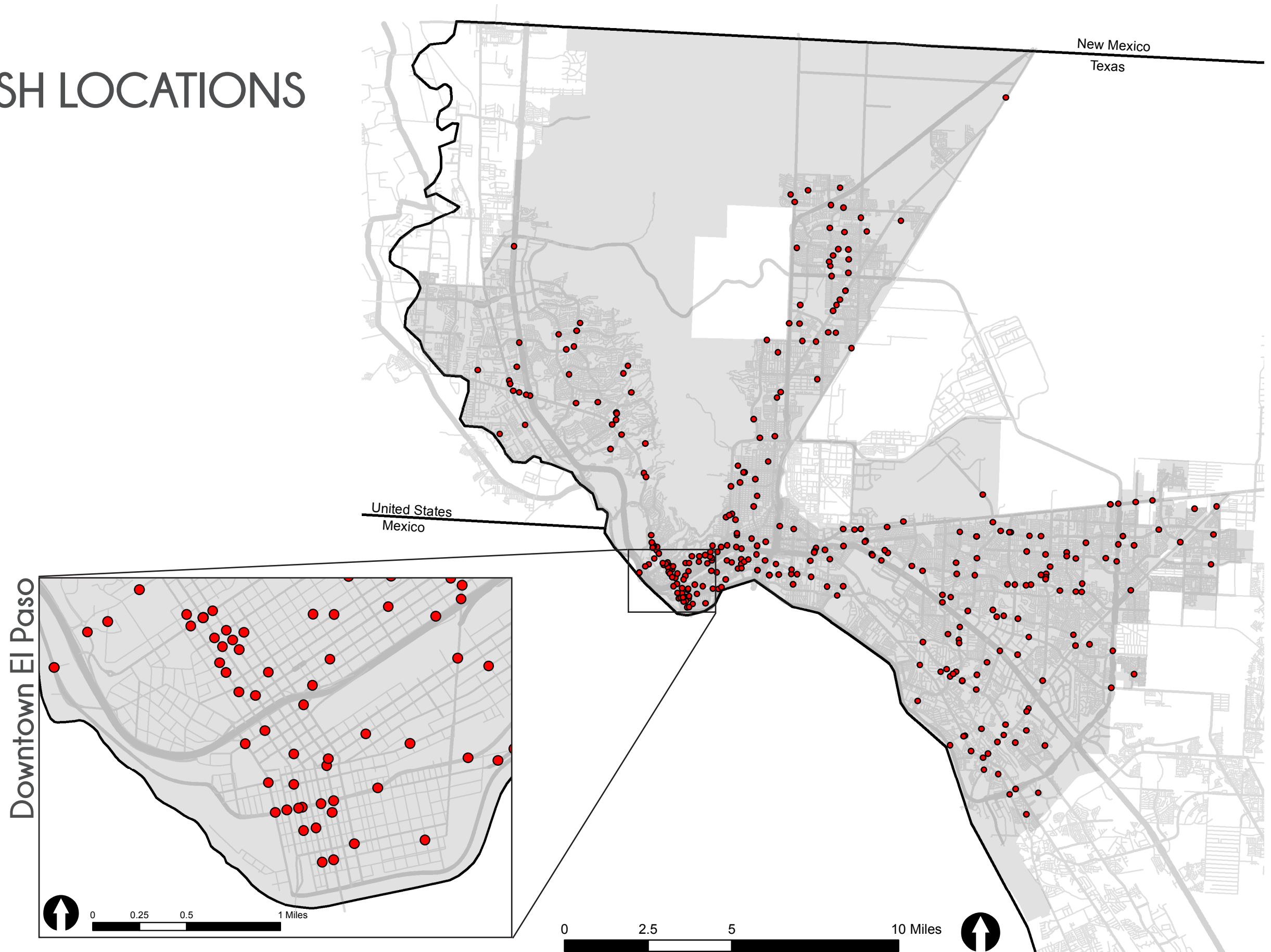

## Public Engagement

Public engagement and input are critical to the long-term success of the City of El Paso Bike Plan. The public engagement process targeted a variety of audiences with varying levels of interest in and knowledge about developing and instituting a bicycle plan. The project team established the public engagement process to achieve the following goals:

- Engage the public on multiple levels, building trust, acknowledging and addressing concerns, and encouraging participants to share their valuable ideas, experiences, and inspiration.
- Define key stakeholders, user groups, and organizations and include them in continued dialogue throughout the process.
- Be inclusive and have a diverse demographic of participants.
- Follow a transparent and meaningful process of communication.
- Show participants how their ideas are being incorporated into the plan, and if not, why not.
- Provide participants with key information and an opportunity to offer relevant and valued insight and opinions on issues.
- Use multiple methods of outreach, mixing traditional methods with newer technology to broaden the cross section of interested participants.
- Continue to conduct public input surveys, meetings, opinions on programs, projects, and bicycle facilities.
- Conduct annual meetings with bicycle community, partners, and stakeholders to ensure ongoing feedback on plan progress and facility maintenance.

The outreach audience included the core stakeholder group, the general public, and municipal leaders. Stakeholders identified in key organizations and leaders in the City that are well-positioned to influence planning efforts and will be critical to the implementation were engaged to get broad input and support for the Plan and

its implementation. The public, including citizens, active commuters, recreational riders, future users, advocacy groups, pedestrians, and motorists, were engaged to build awareness and educate the public about different opportunities and strategies to increase bicycling activity and enhance safety for people riding bicycles and other road users. Municipal leaders across the entire City of El Paso, including both elected officials and organization leaders, were engaged to educate, create an understanding of the most up-to-date knowledge in bicycle network planning and design, promote cross-department communication and cooperation for improved planning, increase support, and inspire them to initiate and participate in project planning and implementation.

## Communication Methods and Events

In order to engage a diverse public on multiple levels, the team focused on building trust, presenting information in a straightforward manner, listening, and addressing concerns as they arose. The team used outreach strategies designed to reach the widest audience possible, including conventional (community meetings, media releases and newsletters, comment cards) and technology-driven methods (online surveys, virtual Open Houses, and Facebook).

Multiple means of communication were used throughout the Plan development process to make the process as transparent as possible. The team recognized the need to have both traditional and electronic outreach methods.



Figure 25. The bike plan's brand was introduced at the public kick-off event.



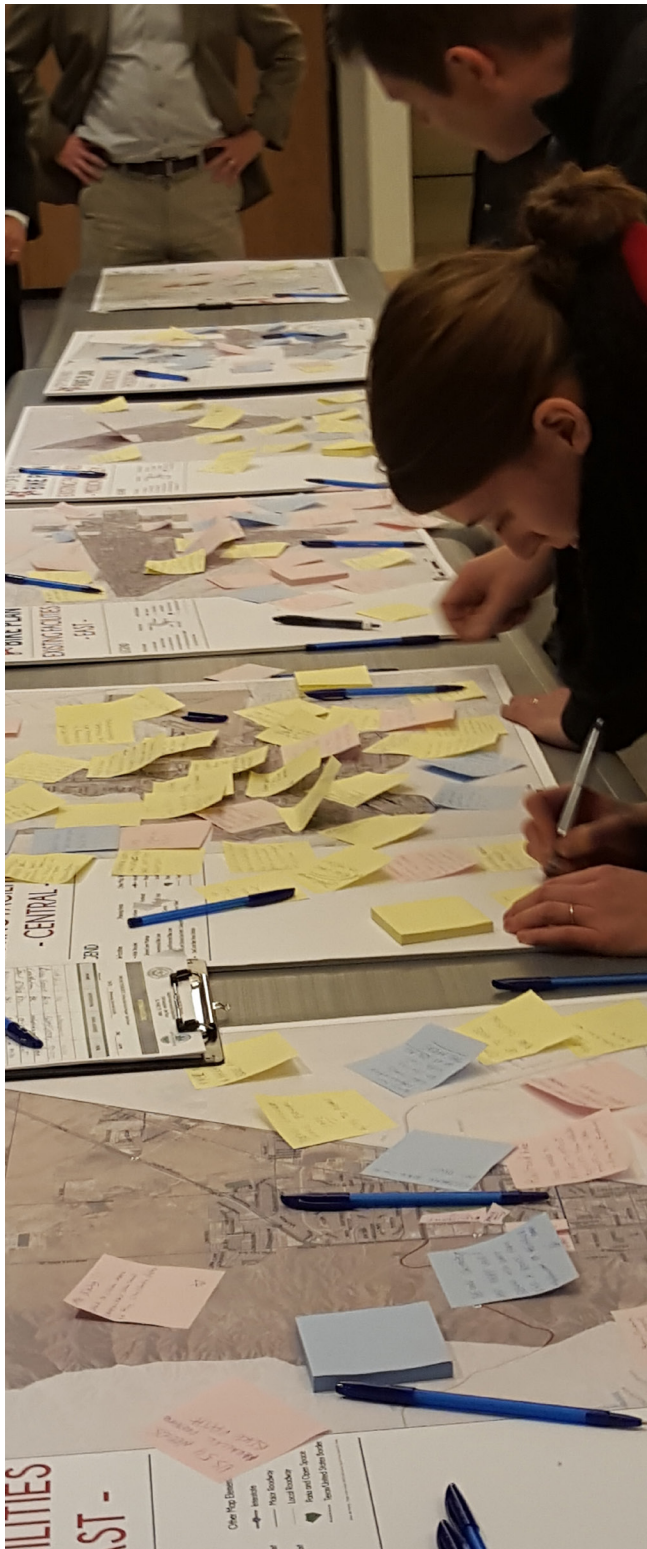

Figure 26. Residents comment on maps during the first public workshop.

## Branding

A visually appealing image was developed to help create a recognizable identity through printed materials, the Internet, and other communication materials over the eight-month planning and engagement process.

## Public Kick-Off Event

A public kick-off event, Chalk the Block, took place on October 9, 2015, along El Paso Street and Franklin Avenue adjacent to Cleveland Square Park. The team temporarily chalked a protected bike lane and bike box on El Paso Street and allowed the users to test the innovative bikeway design with their own bikes, or with bikes provided at the event. The public was able to get a feel for modern bikeway treatments, and the planning team was able to develop contact lists and provide information about the plan and upcoming public workshop.



Figure 27. Attendees test a bike box at the “Chalk the Block” kick-off event.

## Public Workshop 1

The first public workshop took place on December 2, 2015, and 104 El Pasoans from around the city attended. Residents were presented a brief overview of the planning process and draft goals for the plan and then were asked to comment through a series of polls and interactive boards, presented in both English and Spanish. Participants were able to select a preferred bicycle facility, identify their current attitude towards biking, and comment on specific map areas.

## Community Meetings

City staff and planning team members hosted five community meetings throughout the city to engage a broader scope of the community. Over ninety residents attended these meetings, which consisted of the following:

- Mission Valley Regional Command Center, 9011 Escobar Drive, Thursday, January 21, 2016
- Northeast Regional Command Center, 9600 Dyer Street, Tuesday, January 26, 2016
- Pebble Hills Regional Command Center, 10780 Pebble Hills Boulevard, Wednesday, February 3, 2016

- Grandview Senior Center, 3134 Jefferson Avenue, Wednesday, February 10, 2016
- Westside Regional Command Center, 4801 Osborne Drive, Thursday, February 18, 2016

At each of the community meetings, City staff and the planning team presented the overall goals of the project, and residents were able to provide comment cards on bicycle infrastructure and participate in real-time polling to share their input and immediately see the input of the entire audience.

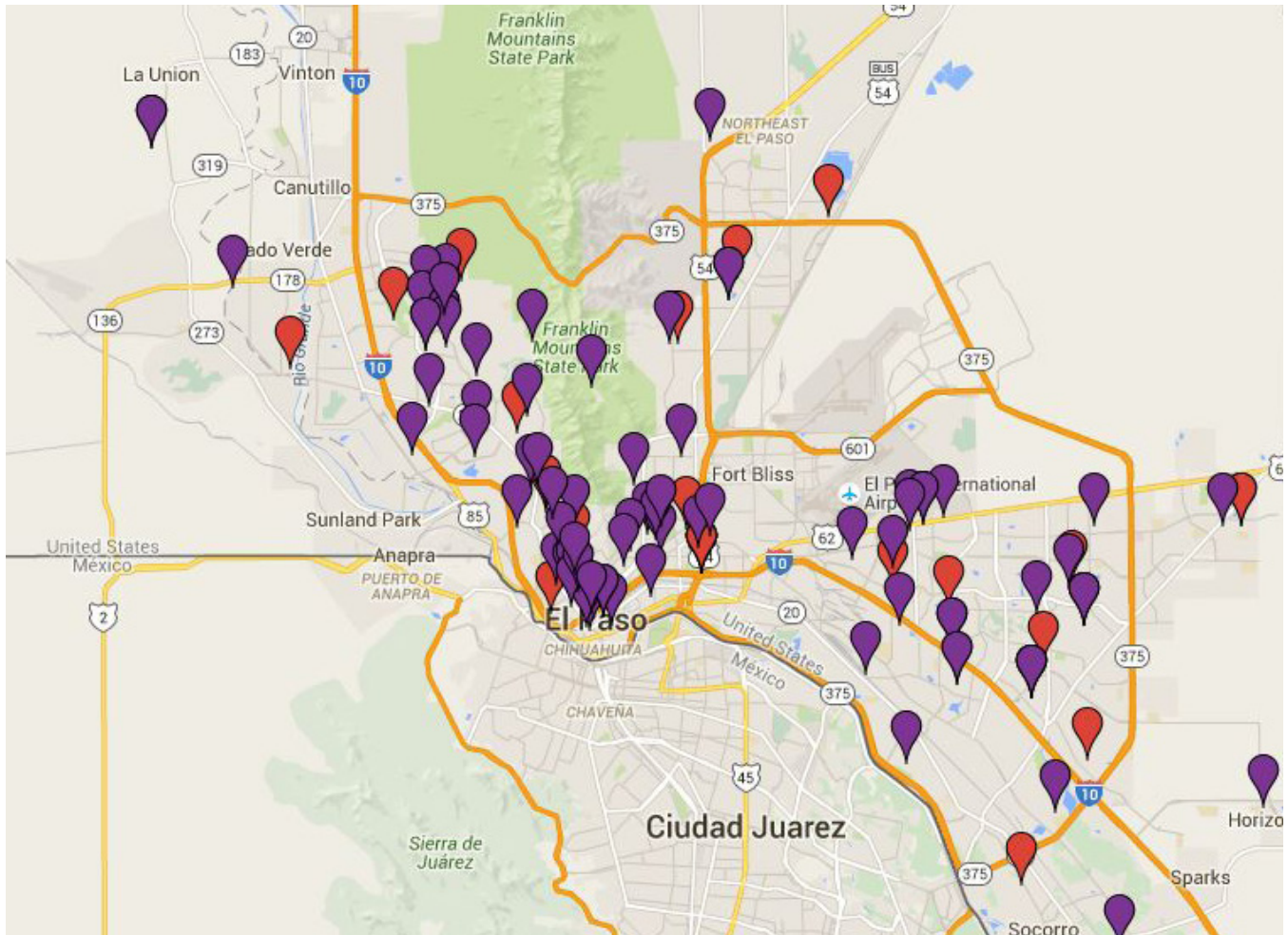

Figure 28. Residents throughout the City of El Paso and surrounding communities attended public workshops and community meetings (base map ©2016 Google).





Figure 29. Attendees listen to a presentation at the second public workshop.



Figure 30. Bicyclists arrive at the second public workshop.

### Marathon Outreach

The team set up an information booth at the El Paso Marathon Expo on February 20, 2016, in an effort to reach active El Pasoans, gather feedback on existing bicycle facilities, and encourage attendance at the second public workshop.

### Public Workshop 2

The second public workshop on March 24, 2016, allowed over 112 residents to review the draft bikeway network and learn about bicycle facility types. The team presented videos of how to use new recommended facilities, such as a bike box. Attendees then were able to leave comments on maps of the recommended network improvements.

### Online Mapping Tool

Residents were invited to comment on the existing bicycling infrastructure through an online wikimap. The map software allows users to drop lines and points on the map and comment. Subsequent visitors can add additional comments and agree or disagree with existing comments. The map included the existing bicycle infrastructure, and residents were asked to add additional desired pathways, destinations they would like to bike to, intersections to be improved, additional bike share stations, and places for bike parking.

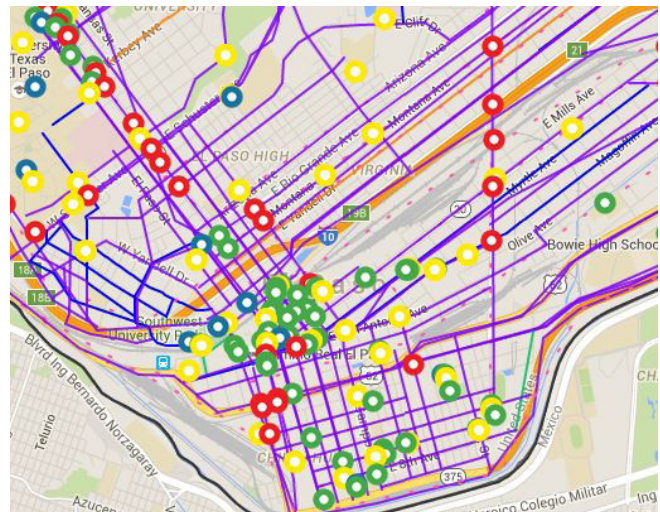

Figure 31. Close-up view of online comments in the downtown area (base map ©2016 Google)

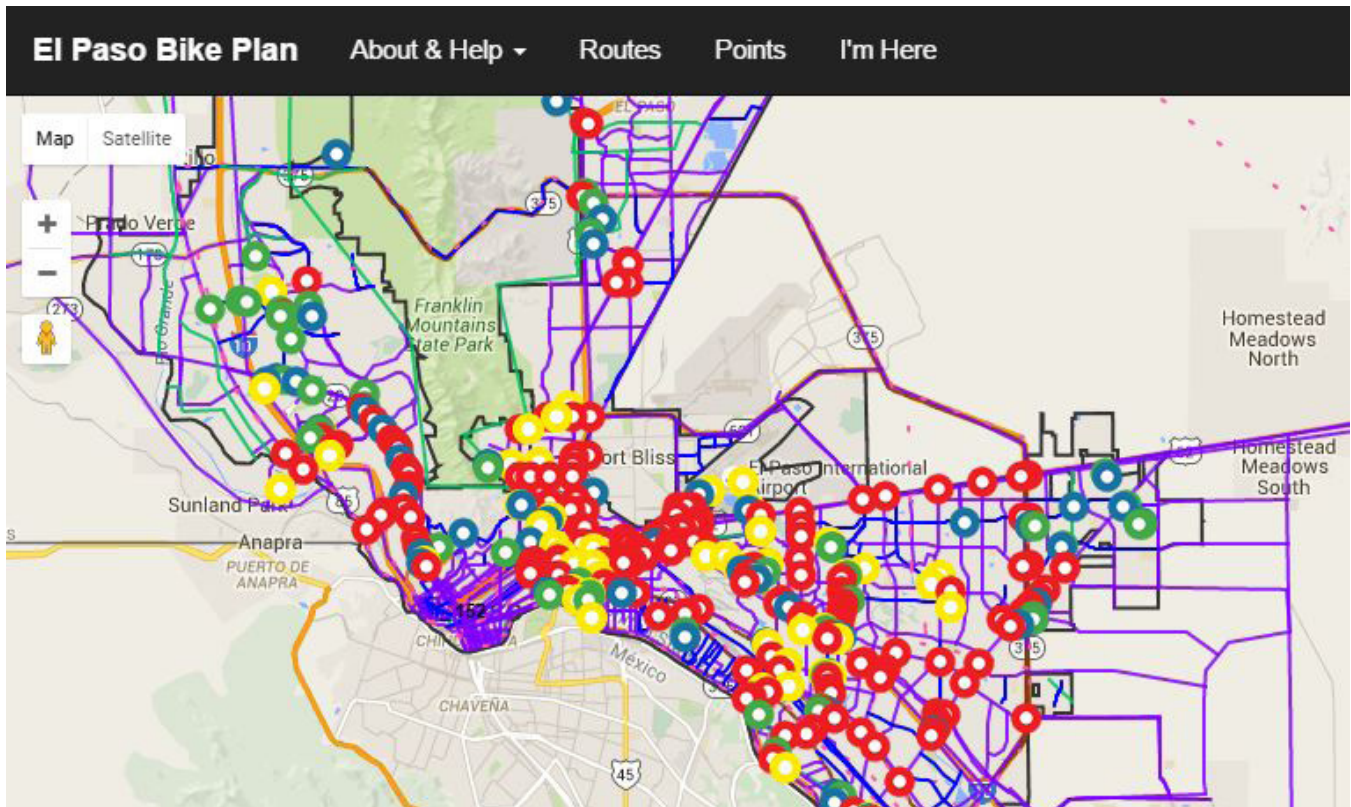

Figure 32. Comments on the interactive map were distributed throughout the City of El Paso (base map ©2016 Google).

### Community Feedback

Overall comments on maps were related to connectivity, safety, and bicycle facilities. Specific comments from residents can be categorized as follows:

- Connectivity between points of interest and residential and commercial areas
- Safety of existing infrastructure
- Maintenance of existing infrastructure
- Additional off-road infrastructure, including use of canals or utility infrastructure
- Rideability concerns, such as steep hills
- Safer intersections
- Additional bike share facilities
- Lack of end-of-trip facilities such as bike parking
- More education and encouragement, including law enforcement
- Improvements to aesthetics, such as landscape or public art

Polling results echoed those comments. Over 77 percent of respondents ranked the existing cycling conditions as bad or really bad. Residents wanted safety and network

### Rating Current Cycling Conditions

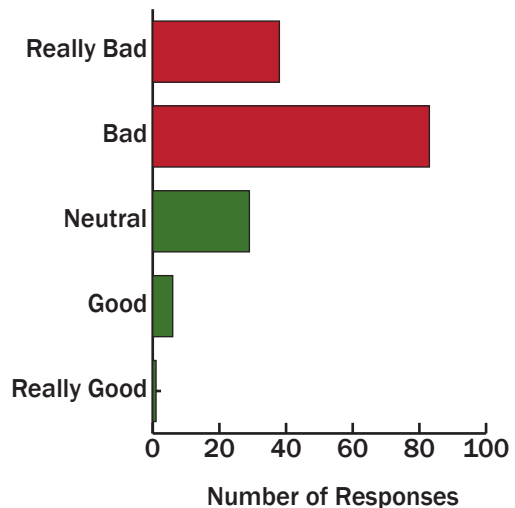

Figure 33. Residents' rating of current cycling conditions



connectivity to be addressed by the planning effort, with 43 percent choosing safety as their primary concern and 38 percent choosing network connectivity. The poll indicated that traffic guidelines and safety were the primary objective they would like to see implemented from the plan, with over 61 percent selecting the option.

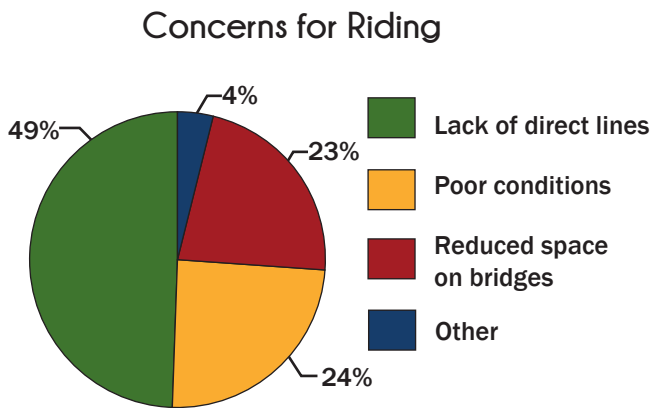

Figure 34. Concerns for riding more in El Paso

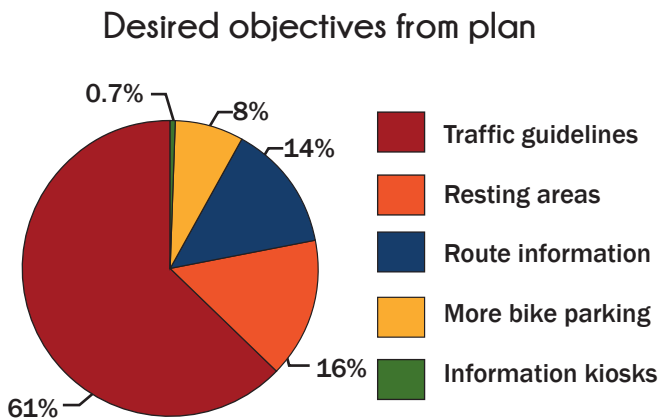

Figure 37. Residents' desired infrastructure improvements

Polling also echoed residents comments on connectivity and maintenance. Over 49 percent identified the lack of direct lines from one side of the city to the other as their biggest concern in commuting, with 24 percent identifying poor conditions as their biggest concern. Residents identified buffered bike lanes as their infrastructure priority, with 80 percent selecting that option.

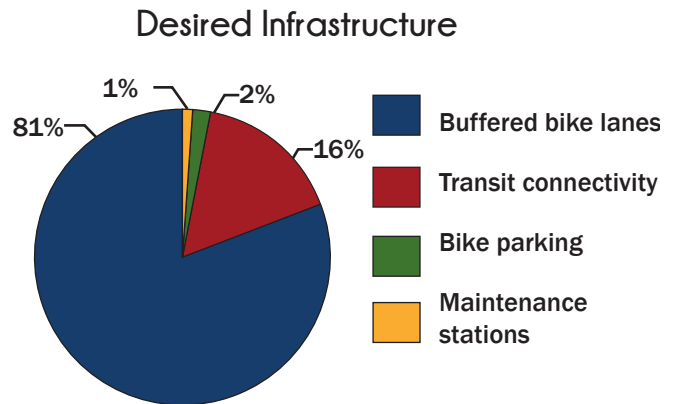

Figure 36. Residents' desired infrastructure improvements

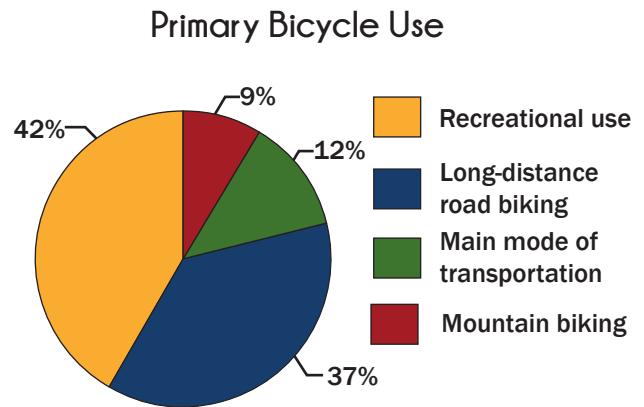

Figure 35. Primary use of bicycles by residents

Most residents used their bikes recreationally, with 41 percent. Twelve percent used it as their main mode of transportation. One third of residents (33 percent) indicated that they would like to use it as their primary mode of transportation, and almost one quarter would like to bicycle for errands or to events (24 and 22 percent, respectively).

## Section 5: Recommendations



## Recommendations

Based on the review of existing conditions, public input, and analysis of the existing network, the team developed recommendations to improve bicycling conditions in the City of El Paso. In addition to bicycle facility recommendations, this chapter outlines additional policies to be implemented and education, encouragement, enforcement, and evaluation programs to encourage their use.

### Network and Facility Recommendations

People who bicycle vary in their physical abilities, their experience levels, and the types of bicycles they ride. To create a comprehensive bicycle network that supports safe and comfortable travel for the diversity of people who bicycle in El Paso, the city must employ different bicycle facility types. Many streets in El Paso, such as low-speed, low-volume neighborhood streets, may not need dedicated bicycle lanes or even pavement markings to provide a safe and welcoming environment for bicycling. Larger roadways that carry more vehicles at higher speeds may require pavement markings, bike lanes, or even protected bike lanes to support bicycle travel. The El Paso Bike Network builds on the existing on- and off-street bikeways and incorporates a variety of bicycle facility types, from signed shared roadways and shared lane markings to protected bike lanes and shared use paths, to create an interconnected bicycle network.

#### Bicycle Facility Types

Bicycle facilities vary greatly in character, context, and intended user. The bicycle facility types described here in this chapter are recommended in the Plan and are described in greater detail in the Bicycle and Pedestrian

Facility Design Guide in the appendix of this document. A number of these bicycle facility types can already be seen throughout El Paso, including shared lane markings, bike lanes, buffered bike lanes, and shared use paths.

#### Signed Shared Roadway

On shared streets, bicyclists and motor vehicles use the same roadway space. Signed shared roadways use guide signs and warning signs to provide wayfinding information to people riding bicycles and to alert people driving motor vehicles to be aware and respectful of other road users. Signed shared roadways are often installed on streets that have considerable constraints prohibiting a more substantial bikeway type, but are essential for addressing a gap in the bikeway network or serving as the final leg of a bicycle route on a low-volume, low-speed roadway.



Figure 38. Example of a signed shared roadway in Jackson Hole, Wyoming

#### Marked and Signed Shared Roadway

A marked and signed shared roadway builds on the basic signed shared roadway described above by incorporating shared lane markings (sharrows). Sharrows are road markings used to indicate a shared lane environment for bicycles and automobiles. Sharrows remind drivers of bicycle traffic on the street and recommend proper bicyclist positioning within the travel lane.



Figure 39. Example of an existing marked shared roadway along Kerbey



Figure 40. Example of a bicycle boulevard in Tucson, Arizona



Figure 41. Photosimulation of a shared bus/bike lane on Oregon



Figure 42. Photosimulation of a bicycle boulevard on Ange

### Bicycle Boulevard

Bicycle boulevards are non-arterial streets with low motorized traffic volumes and speeds, designated and designed to give bicycle and pedestrian travel priority. Bicycle boulevards use signs, pavement markings, and traffic-calming measures to discourage through trips by motor vehicles, while accommodating local access. These facilities provide people of all ages and abilities with comfortable and attractive places to walk and ride a bicycle. Intersection crossing treatments (particularly at arterial crossings) are used to create safer, more comfortable, and convenient bicycle- and pedestrian-optimized streets. People riding bicycles should feel comfortable bicycling two abreast or “conversation riding” while traveling on a neighborhood greenway.

### Shoulder Bikeway

On rural roads with a large shoulder, shoulder bikeways can accommodate bicycle travel. Shoulder bikeways are generally used by commuter and long-distance recreational riders, rather than families with children or more inexperienced riders. Shoulder bikeways often use bicycle lane markings and signage to increase visibility and support safe and responsible roadway use by people on bicycles and people driving motor vehicles.

### Bike Lane

Bicycle lanes designate an exclusive space for bicyclists with pavement markings and signage. The bicycle lane is located adjacent to motor vehicle travel lanes and bicyclists ride in the same direction as motor vehicle traffic.



Bicycle lanes are typically on the right side of the street (on a two-way street), between the adjacent travel lane and curb, road edge or parking lane.



Figure 43. Example of a shoulder bikeway in Ridgewood, California



Figure 44. Example of an existing bike lane along Knights



Figure 46. Photosimulation of a bike lane on Piedras

### Buffered Bike Lane

Buffered bicycle lanes are conventional bicycle lanes paired with a designated buffer space, separating the bicycle lane from the adjacent motor vehicle travel lane and/or parking lane. A buffered bicycle lane could potentially be converted to a cycle track.

### Protected Bike Lane/Cycle Track

Of all on-street bicycle facilities, protected bike lanes, also referred to as cycle tracks, offer the most protection and separation from adjacent motor vehicle traffic. Protected bike lanes are physically separated from motor vehicle traffic and typically provide bicycle travel in the same direction as motor vehicle traffic. They may be at street level, or distinct from the sidewalk, as a raised cycle track. In situations where on-street parking is allowed, protected bike lanes are located adjacent to the curb and sidewalk, with on-street parking repositioned to buffer people on bicycles from moving vehicles.



Figure 45. Example of an existing buffered bike lane along Pebble Hills



Figure 47. Photosimulation of a buffered bike lane on McRae



## Two-Way Cycle Track

A two-way cycle track is an on-street bicycle facility that allows bicycle movement in both directions on one side of the street. A two-way cycle track may be configured as a street level cycle track with a parking lane or other barrier or as a raised cycle track to provide vertical separation from the adjacent motor vehicle lane. Two-way cycle tracks must provide clear and understandable bicycle movements at intersections and driveways. Education is important to inform people how to travel in a safe manner.



Figure 49. Example of a protected bike lane in Missoula, Montana



Figure 50. Example of a two-way cycle track in Seattle, Washington



Figure 48. Photosimulation of a two-way cycle track on Campbell



## Shared-Use Path

A shared-use path, also called a multi-use trail, allows for two-way, off-street bicycle use and may be used by pedestrians, skaters, wheelchair users, joggers and other non-motorized users. These facilities are frequently found in parks, along rivers, and in greenbelts or utility corridors where there are few conflicts with motorized vehicles. Because of their separation from motor vehicle traffic, shared-use paths appeal to the widest variety of user types, from families with children to adult recreational riders to everyday commuters. When these linear shared-use paths lead to popular destinations or connect to the on-street bikeway network, their utility expands greatly, offering a comfortable, low-stress bicycling environment for people to use for everyday trips.



Figure 51. Example of a shared-use path in El Paso



Figure 52. Photosimulation of a shared-use path on Viscount

## Bicycle Facility Recommendations

When complete, the El Paso Bike Network will consist of more than 900 miles of bikeways linking El Pasoans to schools, parks, employment opportunities, cultural amenities and institutions, Sun Metro buses and streetcars, SunCycle bike share stations, and ultimately to one another. Table 8 lists each bikeway type included in the network, as well as the number of recommended miles for each. Because these recommendations are conceptual in nature, some recommendations may change as individual projects are designed and implemented.

Map 12 shows the overall recommended network. The complete bicycle transportation system is depicted in the El Paso Bike Network Atlas, which is included in Appendix B. The Atlas cover shown depicts existing and recommended facilities for the entire city, along with a grid index to help guide readers to the appropriate atlas page for greater detail.

## Future Bicycle Level of Traffic Stress and Connectivity

As the El Paso bike network develops based on the recommendations outlined in this Plan, El Pasoans will begin to benefit from increased transportation choices and enhanced connectivity to the people and places around them. At full build-out, the recommended bike network will have a truly transformative impact on the city, offering a world-class transportation system for people on bicycles. The network will be accessible not just to those with years of experience riding on El Paso streets, but to the vast majority of El Pasoans, regardless of the number of miles they have logged over the years. To illustrate this impact, Map 13 displays the future bicycle level of traffic stress on El Paso roadways once the recommended network is completely installed. While the implementation of these recommended bikeway projects will take years to complete, each successive project will enhance the existing bike network and create low-stress routes for bicycling in El Paso.

Map 14 further illustrates the transformative impact of the recommended bike network by displaying low-stress bicycle connectivity. The current low-stress connectivity

clusters map (Map 10) revealed more than one hundred individual clusters of low-stress bikeways separated by high-stress arterial roads, limited access highways, and other barriers. The future low-stress connectivity map shows an entirely different bicycle transportation system. The red lines on the future low-stress connectivity map represent interconnected low-stress bikeways, including shared-use paths, protected bike lanes, bicycle boulevards, other bikeway types, and even non-network local streets that will provide a safe and comfortable bicycling experience for the majority of El Pasoans traveling by bicycle.

This low-stress network connects all corners of El Paso, from the Westside Sports Complex in Northwest El Paso, to the Paso Del Norte Port of Entry in Chihuahuita, to Chuck Heinrich Park in Northeast El Paso, and to the Rio Bosque Wetlands Park in the Lower Valley. The gaps in the bicycle network that currently exist will be addressed through the installation of high-quality bikeways that will result in unparalleled access and connectivity, bringing to life entirely new possibilities for urban and suburban

transportation in El Paso.

### Bicycle Wayfinding

Landmarks, destinations, neighborhood business districts, natural features and other visual cues help residents and visitors navigate through El Paso. However, many of the recommended bicycle routes utilize less familiar, lower-volume roadways that may not be as familiar to many people, who may typically use an alternate route when traveling by bus or car. The placement of wayfinding signs throughout the El Paso will indicate to bicyclists their direction of travel, the location of popular destinations, and the distance (and travel time by bike) to those destinations. This will in turn increase the comfort, convenience and utility of the bicycle network. Wayfinding signs also provide a branding element to raise the visibility of the City's growing active transportation network.

El Paso will benefit from an on-street wayfinding signage system for use along bicycle facilities. Signage can serve both wayfinding and safety purposes, including:

**Table 7. Recommended Network Mileage**

Bicycle Facility Type	Existing Miles	Recommended Miles	Total Future Miles*
Shared-Use Path	31	271	304
Two-Way Cycle Track		8	8
Protected Bike Lane / Cycle Track		44	44
Buffered Bike Lane	7	157	157
Bike Lane	62	222	284
Shoulder Bikeway	29	12	40
Bicycle Boulevard		84	84
Shared Lane Markings	11	67	71
Signed Shared Roadway		14	14
Further Study Needed		60	60
<b>Total Network Miles</b>	<b>140</b>	<b>938</b>	<b>1066</b>

\*Some recommended facilities will upgrade or replace existing miles, and therefore, total future miles is not a direct sum of existing and recommended miles columns.



## End-of-Trip Facilities

End-of-trip facilities are an integral component of a successful, functional bicycle network. Without secure, accessible, and convenient bicycle parking, people are less likely to choose to ride a bicycle. The City of El Paso and its community partners should continue to increase bicycle parking supply with secure, attractive, and highly visible bicycle parking facilities, including short-term bicycle parking solutions like racks and corrals, and long-term solutions like lockers and secure parking areas.

Providing context-appropriate facilities to enhance El Paso’s bike network could be as simple as providing short-term bicycle parking outside popular destinations and secure bicycle parking at transit stops. Policies requiring secure long-term bicycle parking in new residential and commercial buildings, or the retrofit of older buildings with secure bicycle parking and shower/changing rooms in large employment centers, will make it easier to make

bicycling a habit for future building users. Recognizing that the plan focuses on people of all ages and abilities, bicycle parking should be designed to accommodate a wide variety of bicycle types. Table 8 shows the general characteristics of short- and long-term bicycle parking.

## Design Guidance

While end-of-trip facilities vary greatly in terms of size, capacity, intended parking duration, and other key characteristics, there are minimum standards and best practices to guide the selection and installation of appropriate bicycle racks. The Association of Pedestrian and Bicycle Professionals (APBP) Bicycle Parking Guidelines, 2nd Edition is the industry standard for facility design, selection, installation and maintenance. The City of El Paso should consult this guiding document and recent best practices to develop local standards and guidance for selection and installation of bicycle parking facilities by the city and its partners throughout the region.

**Table 8. Characteristics of Short- and Long-Term Bicycle Parking**

Criteria	Short-Term Bicycle Parking	Long-Term Bicycle Parking
Parking Duration	Less than two hours	More than two hours
Typical Fixture Types	Bicycle racks and on-street corrals	Lockers or secure bicycle parking (racks provided in a secured area)
Weather Protection	Unsheltered or sheltered	Sheltered or enclosed
Security	High reliance on personal locking devices and passive surveillance (e.g., eyes on the street)	Restricted access and/or active supervision Unsupervised: <ul style="list-style-type: none"> <li>• “Individual-secure,” e.g., bicycle lockers</li> <li>• “Shared-secure,” e.g., bicycle room or locked enclosure</li> </ul> Supervised: <ul style="list-style-type: none"> <li>• Valet bicycle parking</li> <li>• Video, closed circuit television, or other surveillance</li> </ul>
Typical Land Uses	Commercial or retail, medical/ healthcare, parks and recreation areas, community centers, libraries	Multi-family residential, workplace, transit, schools

Map 12

# FUTURE BICYCLE LEVEL OF TRAFFIC STRESS

## Legend

### Bicycle Level of Travel Stress

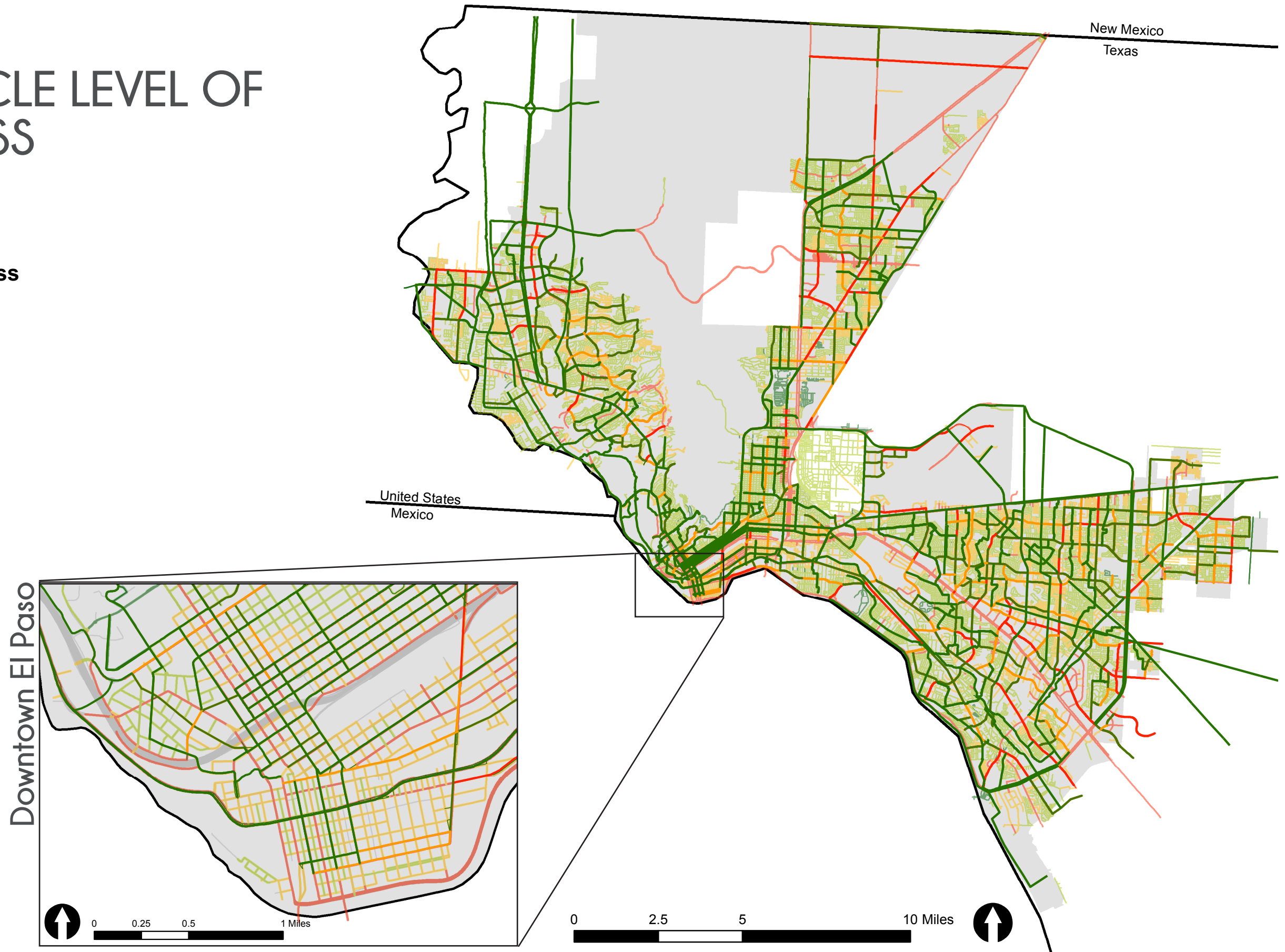

- BLTS 1 (Lowest)
- BLTS 2
- BLTS 3
- BLTS 4 (Highest)



Map 13

# FUTURE LOW-STRESS CONNECTIVITY CLUSTERS

## Legend

-  LTS 1/2 Routes Connected by Network Buildout
-  Previously Existing LTS 1/2 Routes

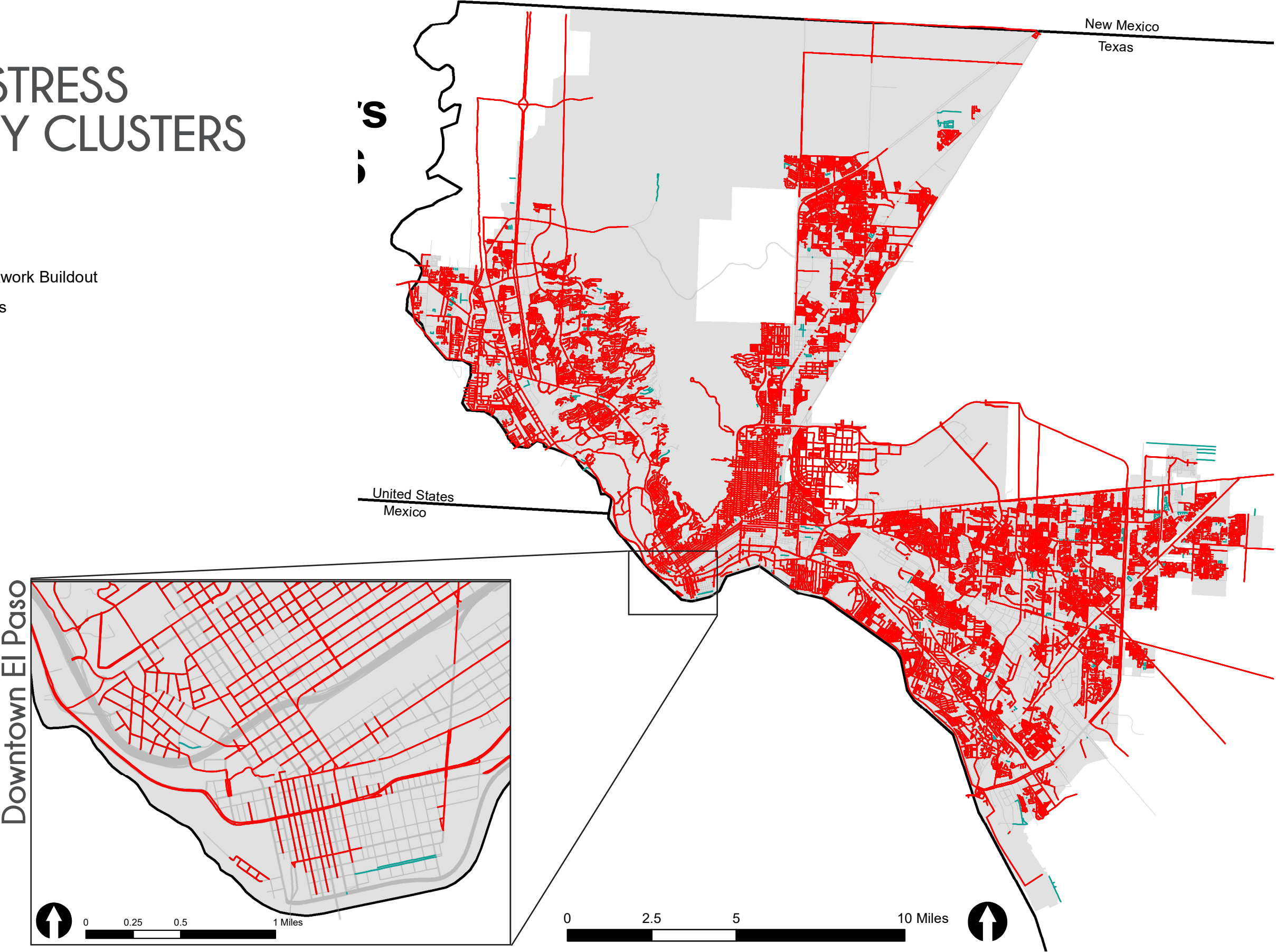



Map 14

# RECOMMENDED BIKEWAY NETWORK

## Legend

### Existing Bicycle Facilities

- Bike Lane
- Buffered Bike Lane
- Shared-Use Path
- Shared Lane Markings
- Shoulder Bikeway

### Other Features

- SunCycle Bike Share Station
- Parks
- City of El Paso

### Proposed Bicycle Facilities

- Bicycle Boulevard
- Bike Lane
- Buffered Bike Lane
- Protected Bike Lane / Cycle Track
- Further Study Needed
- Shared-Use Path
- Shared Lane Markings
- Shoulder Bikeway
- Signed Shared Roadway
- Two-Way Cycle Track

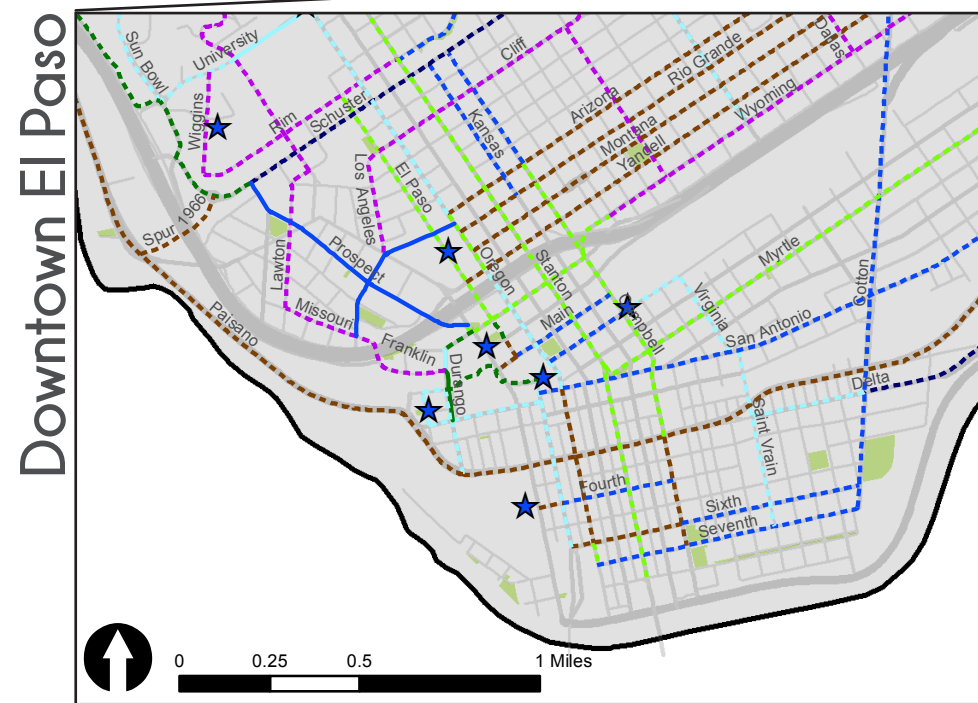
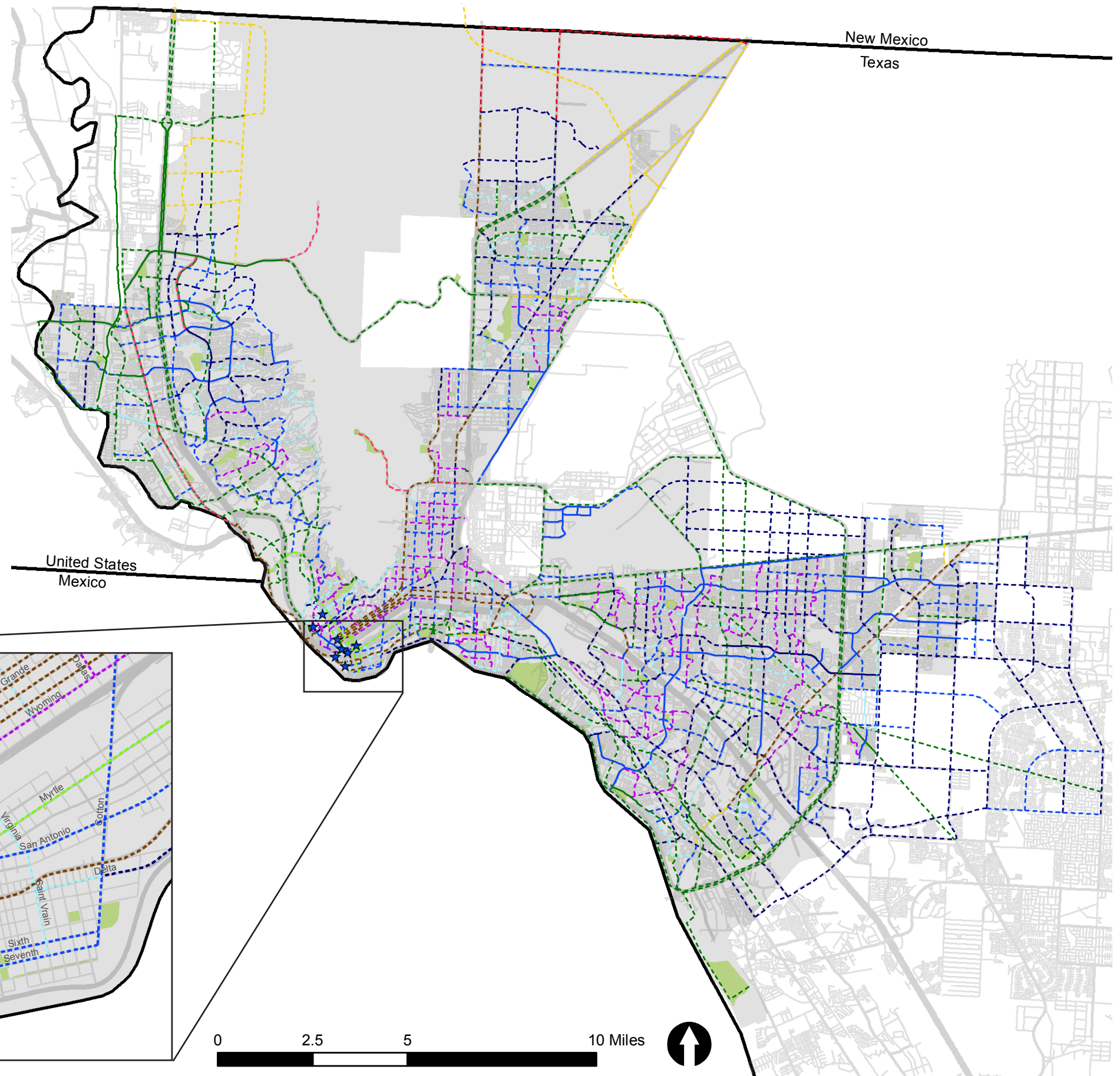



- Helping to familiarize users with the bikeway system
- Helping users identify the best routes to destinations
- Helping to address commonly-held perceptions about travel time and distance
- Creating seamless transitions between on-street and off-street bikeways
- Helping overcome a “barrier to entry” for people who do not bicycle often and who fear becoming lost
- Alerting motorists that they are driving along a bicycle route and should use caution

Signs are typically placed at key locations leading to and along bicycle routes, including the intersection of multiple routes. El Paso should create a community-wide Bicycle Wayfinding Signage Plan that identifies:

- Sign locations along existing and planned bicycle routes
- Sign type—what information should be included and what is the sign design
- Destinations to be highlighted on each sign—key destinations for bicyclists
- Approximate distance and riding time to each destination

General cost estimates for wayfinding signage range from standard Manual of Uniform Traffic Control Devices (MUTCD) signage to customized signage with branded elements and posts. Costs of wayfinding signage will depend on the type of signing and materials chosen for fabrication of the signs.

## SunCycle Bike Share Expansion

While still in its infancy, the SunCycle bike share system is growing to become an integral part of the El Paso's multimodal transportation system. The current network serves many important businesses, institutions, and amenities from UTEP south to Downtown El Paso, creating opportunities for students, area employees and residents, and tourists and visitors to access the areas' numerous attractions and everyday destinations. Planning for additional station locations is underway and is benefitting from months of usage data collected since the system's opening in September 2015. As the bike network continues to grow in the coming years, more and more El Pasoans and visitors to the city will see bicycling as a viable mode of transportation. The City of El Paso and its regional partners should continue to plan for future expansion to provide optimal station spacing and coverage in concert with network growth.

## Program Recommendations

The infrastructure recommendations in the El Paso Bike Plan will provide safer, more comfortable places that further grow bicycling. However, while improving infrastructure is critical to increasing bicycling rates, the importance of education, encouragement, enforcement, and evaluation programs should not be underestimated.

Programs can ensure that more residents know about new and improved facilities, learn about the benefits of bicycling, and receive positive reinforcement about why and how to integrate bicycling into their everyday lives. In essence, these efforts market bicycling to the general public and provide the maximum “return on investment” in the form of more people bicycling and a higher degree of safety and awareness around bicycling in El Paso.

The following program recommendations contain an overview of programs that should be pursued along with infrastructure investments.

### Existing Programs

When it comes to creating a culture for bicycling, the City of El Paso does more than just build and maintain bicycle-friendly streets. Working with various agencies and community partners, the City hosts bike workshops for residents, provides online resources and information, and has implemented the Employee Bike Pool. These efforts show that the City is working hard to encourage bicycling for both recreation and transportation.

The following section will evaluate the City’s current programs (Online Bike Information Resources website and the Employee Bike Pool) and provide recommendations to enhance existing efforts.

#### Online Bike Information Resources

Although the City’s website houses information on the benefits of bicycling, safety tips, bike share and bike pool information, and links to community groups, the website offers little information on how to get around by bike in El Paso. While the existing resources provide specifics on programs and community partners, they do not provide the information that potential bicyclists need in order to

explore El Paso. It is recommended to update the existing website so it truly becomes a resource that provides easy-to-find information about bicycling around the city or to/from important civic centers and destinations, like downtown or a border crossing to Ciudad Juárez.

Furthermore, the City will implement a series of new infrastructure projects that will improve bicycling safety and comfort around the city. Although there is a link under “bike lanes” that directs web visitors to the Streets & Maintenance department, it does not elaborate on the proposed infrastructure improvements nor promote the goals and objectives of the Bike Plan.

The website should act as a clearinghouse to share the city’s goals for future bicycling projects, policies, and programs. The City’s bicycling website should include the following information:

- Maps and other bicycling resources (e.g., bicycle parking locations, Citywide bike map, bikes on Sun Metro transit, El Paso SunCycle, how to securely lock a bike, etc.)
- Event postings including clinics or workshops, group rides, and volunteer opportunities
- Infrastructure improvements and updates: where projects are happening, project goals, time line, tutorials or graphics on how to use the new infrastructure (both bicyclists and drivers), safety statistics, and how to get involved
- Information on how to safely and courteously bike in El Paso, including legal rights and responsibilities, and safety tips
- Information about the City’s BAC, including how to get involved, meeting times, and dates
- Bike Pool Program (why the city invested in the bike pool, who is eligible, how it works, where to sign up)
- A list of all local bicycling groups and advocacy organizations

- Contact information for responsible city staff or the City's Bicycle/Pedestrian Coordinator

The website may also feature:

- A list of local bike shops, including phone number and address
- Repair tutorials (YouTube videos or link to partner resources)
- Blogs featuring stories and news (can be used for infrastructure updates)
- Photo galleries from events and/or submitted by readers
- Popular bicycling route information, such as how to get to Crazy Cat Grande or the Rio Grande River Trail

The City's existing website can be used as the foundation to create an updated version. A one-stop bike website will not be difficult to set up, but it will only be successful if the site is both easy to use and updated regularly. All website content should be reviewed regularly for accuracy. The Bicycle/Pedestrian Coordinator should lead the charge of keeping the website updated with the help of community organizations and partners, the BAC, and other relevant City staff.

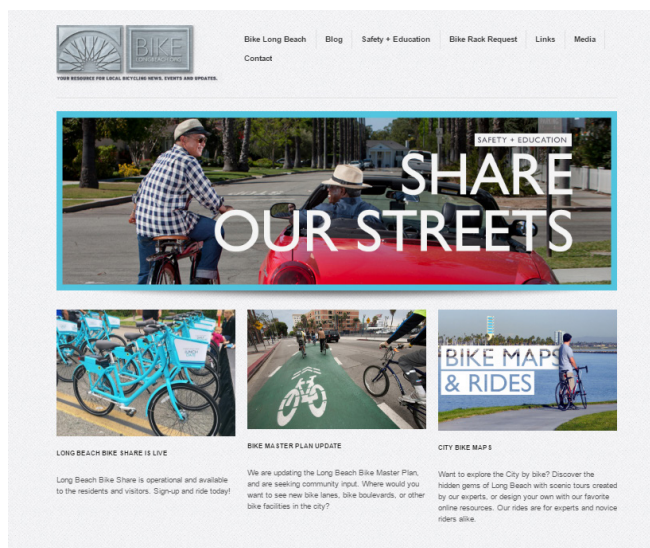

Figure 53. Example website from Bike Long Beach

### Sample Programs:

- City of Austin: [austintexas.gov/bicycle](http://austintexas.gov/bicycle)
- Bike Long Beach (CA): [bikelongbeach.org](http://bikelongbeach.org)

### Bike Pool Program

Started in 2012 to encourage City employees to use alternative transportation and reduce on-the-job vehicle miles traveled, the City of El Paso has a pool of more than fourteen bicycles, which may be moved because of the availability of bikeshare downtown.

Although the program participation is currently low, the city could create incentives to use the bike pool or bike share, such as:

- Creating a “punch card” or reward system for city employees. For example, after an employee uses a bike ten times they are entered into a weekly or monthly drawing for a prize or gift certificate.
- Working with local businesses to offer discounts to employees who arrive on City bikes

### Sample programs:

- City Cycle, San Francisco, CA: [sf-environment.org/article/bicycling/city-and-county-of-san-francisco-employees](http://sf-environment.org/article/bicycling/city-and-county-of-san-francisco-employees)

## Program Recommendations

The program recommendations fall into four categories, informed by the goals and objectives of the El Paso Bike Plan and feedback received from the BAC. These categories include; promoting bicycling as a fun, healthy, and positive activity; law enforcement and education programs; city-led policies and initiatives; and programs that promote safety.

### Promotion Programs

#### Open Streets Events

Open streets events are periodic street closures that create a temporary park open to the public for walking, bicycling, dancing, hula hooping, roller-skating, and other family fun. The purpose of these events is to encourage walking and biking by providing a comfortable space free from traffic. The City of El Paso hosted “Scenic Sundays”

from 2007 to 2011. With the creation of the comprehensive Bike Plan and expected facility upgrades, the City should consider relaunching the open streets event to help support and educate the public on the new facilities, the bike plan goals and objectives, and to encourage active modes throughout the city.

Open Streets may accomplish the following for the City of El Paso:

- Promote and increase the awareness of bicycling and walking as safe and viable modes of transportation
- Increase the health and activity of residents and visitors
- Provide exposure to the City’s investment in bicycle infrastructure and improvements
- Foster a sense of community and provide unique social experience for community members
- Offer opportunities to work with local organizations and other agencies to promote bicycling

Through the use of creative activities, Open Streets events can be tailored to promote the use of facilities and to encourage and normalize bicycling. Some activities might include the following:

- “Map your ride” tours and travel planning assistance
- Demonstration projects that showcase potential new road configurations



Figure 54. People bike freely on open streets free of cars during the Los Angeles CycLAvia event.

- Inaugural bike ride
- Hashtag/social media campaign to promote the event(s)

Open streets events can stand on their own or can happen in conjunction with the opening of new bicycle facilities. This not only celebrates the City’s investments in making bicycling safer in the city but also offers the opportunity to provide education to all road users on the new facility. For example, the City of Minneapolis partnered with local advocacy group, Minneapolis Bike Coalition, to conduct a ribbon cutting of a new protected bikeway ([mplsbike.org/oak\\_st\\_the\\_ribbon\\_has\\_been\\_cut](http://mplsbike.org/oak_st_the_ribbon_has_been_cut)) during an open street event.

The Open Streets Project, a collaboration between the Alliance for Biking & Walking and the Streets Plan Collaborative, aims to share information and resources about open streets events with communities around North America. The Open Streets Project offers an interactive website and free Open Streets Guide to assist organizers. The guide presents seven model types of open streets events, referred to as the Seattle, Cleveland, San Francisco, Portland, Winnipeg, Savannah, and Kentucky models.

**Sample Programs:**

- Cyclovia Tucson, Tucson AZ: [cycloviatucson.org](http://cycloviatucson.org)
- Viva! Streets Austin, Austin TX: [vivastreetstx.org](http://vivastreetstx.org)
- Sunday Streets, Houston, TX: [gohealthyhouston.org/sundaystreetshtx](http://gohealthyhouston.org/sundaystreetshtx)

**Resources:**

- Open Streets Project: [openstreetsproject.org/resources](http://openstreetsproject.org/resources)

*Annual Bike Month*

National Bike Month in May is a celebration filled with events, outreach, and competitions that promote and encourage bicycling as a safe and viable form of transportation. Bike Month introduces bicycling to new riders and cultivates and supports local bike culture. Bike Month in El Paso is currently organized through Velo Paso. Velo Paso has a strong presence in the community; this creates an opportunity for the City to collaborate with the organization to leverage the existing program



and enhancing current efforts. El Paso Bike Month ([elpasobikemonth.com](http://elpasobikemonth.com)) currently organizes community-led bike rides and workshops featuring a variety of themes (e.g., May the 4th be with you Star Wars Ride, Winery Ride, Beginner Mountain Bike Ride, and Cyclo Femme). It is recommended that the City continue to participate in Bike Month because there are many benefits to the City; participation shows that the City supports and encourages bicycling and can build community support for improvements. Below are some events that the City could sponsor or produce in tandem with Velo Paso, other organizations, or individuals:

- Bicycle ride with the Mayor and/or District Representatives
- Bike-in movies to a city park
- Family rides/Kidical Mass
- City employee commute challenge
- Bike safety/maintenance workshops
- Pop-up bike repair stations
- Light the night campaign
- Media campaign



**Figure 55.** Velo Paso organizes a number of events during El Paso Bike Month.

Events like these help to foster support for bicycling and break down real or perceived barriers for new riders. The League of American Bicyclists has created a how-to guide that provides steps to getting started and a variety of event ideas ([issuu.com/bikeleague/docs/nbm\\_guide\\_2015\\_web](http://issuu.com/bikeleague/docs/nbm_guide_2015_web)). The toolkit includes template posters that can be used in storefront windows or on light poles and a variety of digital images and content ready to use on the City's website and social media accounts. They also provide additional resources that are targeted—for example, the workplace poster provides information on the benefits of bicycling, bicycling safety, and information on the Federal Bicycle Commuter Benefit, and the overcoming bike commuting concerns poster helps to eliminate the perceived or real barriers of commuting by bike ([bikeleague.org/content/promotional-materials-0](http://bikeleague.org/content/promotional-materials-0)).

#### Sample Programs:

- City of Fort Collins, CO: [fcgov.com/bicycling/bike-month.php](http://fcgov.com/bicycling/bike-month.php)
- City of Sacramento, CA: [mayisbikemonth.com](http://mayisbikemonth.com)
- City of Boulder, CO: [walkandbikemonth.org](http://walkandbikemonth.org)

### Bike Maps and Informational Materials

Bike maps do much more than point out where the bike lane or trail goes. Maps can offer guidance about bike etiquette and rules, highlight local destinations, and showcase the City's commitment to active transportation.

The map should recommend routes for getting to key local destinations, such as how to cross the border on bike. Furthermore, the maps should display bike travel times and distances and offer basic traffic safety tips. Maps can be distributed to local businesses, schools and universities, employment centers, and the bureau of tourism. Maps can be distributed at events as an outreach tools to help lessen the real or perceived fear of getting lost or taking an unsafe route.



Figure 56. The City of Chicago's program Go Edgewater, "Go Map" features bicycle and transit routes, points of interests, community art, and bike parking.

It is further suggested that the City produce a digital map as well that can live on the City's Bike Information Resources webpage. This can be in the form of a digital download or an interactive map.

The map should feature a user-friendly design that is intuitive and legible for people of different ages and abilities. If available, a GIS base layer is recommended as a starting point when creating such a map. Once a draft map has been created, it should be reviewed for accuracy by individuals who are familiar with the area. The map should be dated to communicate how current it is and may need to be updated and reprinted in the future as changes to infrastructure or destinations take place.

### Sample Programs:

- Arlington, VA (digital download + paper version): [bikearlington.com/pages/maps-rides](http://bikearlington.com/pages/maps-rides)
- Memphis, TN (digital download + paper version): [memphistravel.com/memphis-bike-map](http://memphistravel.com/memphis-bike-map)
- Des Moines, IA (Interactive online map): [dmampo.maps.arcgis.com/apps/webappviewer/index.html?id=c48776f60395490eb3029f5b29fc7b88](http://dmampo.maps.arcgis.com/apps/webappviewer/index.html?id=c48776f60395490eb3029f5b29fc7b88)

### Smart Cycling Quick Guide

Bicycling information can come in a variety of forms. As stated above, a map can incorporate safety tips and bike etiquette. Although some cities do create customized handouts, we suggest the League of American Bicyclists Smart Cycling Quick Guide as a starting point. The Smart Cycling Quick Guide is an easy-to-use manual that gives guidance on how to fit a helmet, how to signal, tips for riding at night, general rules of the road, and tips on how to maneuver through intersections and on bike lanes. It is a great general resource that covers the basics for bicyclists.

- Price: Suggested donation of \$1 per brochure (when ordering 50 to 500)
- Language(s): English and Spanish
- [bikeleague.org/quickguide](http://bikeleague.org/quickguide)



## SMART CYCLING QUICK GUIDE



Figure 57. The League of American Bicyclists Smart Cycling Quick Guide is a general basic resource for bicyclists.

### Family Bike Guide

Several jurisdictions have created Family Biking Guides (e.g., the San Francisco Bicycle Coalition and the City of Portland) that provide bicycling tips for biking while pregnant, with babies, and with toddlers. Previously, the City of Portland has given permission to municipalities to use their design and content for free. El Paso should request permission to use the native file and update the content so it is specific to El Paso residents. The Family Bike Guide could be an online resource while funding for printing is being secured. Contact [Active.Transportation@portlandoregon.gov](mailto:Active.Transportation@portlandoregon.gov) for more details.

### Bicycle Safety Training and Maintenance Workshops

Classes and workshops provide education and skills training to bicyclists of varying confidence levels. Training classes and workshops offer many benefits: they enhance understanding, confidence, and independence related to bicycling for transportation and provide a supportive learning environment where participants can ask questions or express concerns. Furthermore, classes can be tailored to a variety of topics and demographics, such as:

#### General Classes:

- Basic bike maintenance
- How to change a tire
- Safe riding and traffic skills training
- Shopping by bike
- Commuting 101
- Bicycle legal clinic
- No car needed: how to get around without driving

#### Demographic Specific:

- Women's maintenance 101
- Youth safety and skills training
- Families on bike
- Spanish-language classes

#### Location Specific:

- Employer-based workshops
- University-based classes
- Riding to Ciudad Juárez

The City should partner with local bike shops, advocacy groups, or community members to host workshops and classes. The presenter of the workshop should be confirmed a month or so in advance of the workshop to give adequate preparation time. Workshops should be held at lunch time, or in the evening or weekends to accommodate work and school schedules.

#### Sample Programs:

- City of Cambridge, MA, Bicycle Workshops: [cambridgema.gov/CDD/Transportation/bikesincambridge/bicycleworkshops](http://cambridgema.gov/CDD/Transportation/bikesincambridge/bicycleworkshops)
- Corporate Commute Workshops (Bike Silicon Valley, CA): [bikesiliconvalley.org/corporate-commute-workshops](http://bikesiliconvalley.org/corporate-commute-workshops)
- City of Portland, OR, Portland by Cycle Rides and Classes: [portlandoregon.gov/transportation/44099](http://portlandoregon.gov/transportation/44099)

## Law Enforcement Training and Education

### *Law Enforcement Collaboration*

Proper enforcement comes from a strong, communicative relationship between transportation staff and local law enforcement. To contribute to a collaborative partnership between the City and local law enforcement, a representative of the El Paso Police Department (EPPD) should be invited to attend monthly BAC meetings to serve as the liaison between the EPPD and transportation professionals and advocates. During these meetings, the Police Department can learn more about the unsafe behaviors of all road users and evaluate the best methods of enforcement. The Police Department will also have the opportunity to evaluate how new bicycle infrastructure might affect road user behavior and help predict public education needs.

The Police Department should seek their own funding to do targeted enforcement of illegal, unsafe behavior of motorists, bicyclists, and pedestrians. Law enforcement officers could focus on behaviors known to be the most dangerous, such as motorist right-hook turns and bicyclists not using lights at night. The Police Department should work with the City and BAC to promote bicycling as a safe activity for everyone. Some programs have a tiered system of enforcement. In Tucson, AZ, when conducting bike light enforcement, the police officers prefer to start with education, warnings, and free lights, followed by citations if the issue persists.

### Resources:

- The Coalition of Arizona Bicyclists, in partnership with Glendale Police Officers, created a brief training video for local law enforcement covering relevant traffic laws, common crash types and frequency, best bicycling practices, and effective enforcement techniques [cazbike.org/bicycle-law-enforcement](http://cazbike.org/bicycle-law-enforcement)
- Chicago Police Training Video: [chicagobikes.org/video/?loadVideo=police\\_training\\_2009](http://chicagobikes.org/video/?loadVideo=police_training_2009)

## City-Led Policies, Initiatives, and Staffing

### *Bicycle/Pedestrian Coordinator*

A number of cities around the country staff a part-or full-time Bicycle/Pedestrian Coordinator. The coordinator is responsible for current bicycle planning and safety efforts, and assisting with the implementation of City bicycling programs. The City should create an ongoing Bicycle/Pedestrian Coordinator position. In addition to supporting existing programs (bike pool and website), job duties for this staff position may include the following:

- Monitoring facility planning, design, and construction that may impact bicycling
- Staffing bicycle advisory committee meetings
- Coordinating the implementation of the recommended projects and programs listed in this Plan
- Conducting annual benchmarks to include measures for success, bicycle/pedestrian counts, gather data on number of new of bike lanes, sidewalks, and best practices adherence as it pertains to all bike plan projects, pilot programs, and facility treatments.
- Identifying new projects and programs that would improve the City's bicycling environment and improve safety for bicyclists
- Coordinating evaluation of projects and programs, such as bicycle counts
- Pursuing funding sources for project and program implementation
- Overseeing opportunities for construction and maintenance for bicycle improvement implementation.

### *Vision Zero Policy + Program*

Vision Zero is a holistic approach that aims to achieve zero deaths and zero serious injuries while traveling, regardless of transportation mode. This is done by making safety the top priority for the transportation system and requires a collaborative approach that addresses land use and transportation infrastructure, enforcement, and education. Principles of Vision Zero include the following:

- Traffic deaths and injuries are preventable.
- People will make mistakes; the transportation system should be designed so human error is not fatal.



- Safety should be the primary consideration in all transportation decision-making.
- Traffic safety solutions must be addressed holistically, through:
  - Education, social, and culture change
  - Enforcement and prosecution
  - Land use and transportation engineering

To implement Vision Zero policies, the City will need to have a multi-faceted approach that brings together government, advocacy, and private sector actors and fully engages the public to become part of the solution. If the City chooses to implement Vision Zero, it is recommended that the City create a Vision Zero Task Force. This Task Force will be responsible for the following:

- Collecting and sharing data between agencies
- Evaluating parties and causes of serious or fatal crashes in El Paso
- Identifying and mapping high-crash corridors and intersections
- Developing strategies and countermeasures to reduce or eliminate fatal or serious crashes
- Working with the City’s Bicycle/Pedestrian Coordinator to develop a robust outreach strategy
- Encouraging the City Council to adopt Vision Zero policies, programs, and projects

**Sample Programs:**

- City of New York: [nyc.gov/html/visionzero/pdf/nyc-vision-zero-action-plan.pdf](http://nyc.gov/html/visionzero/pdf/nyc-vision-zero-action-plan.pdf)
- City of Austin: [austintexas.gov/visionzero](http://austintexas.gov/visionzero)
- City of San Francisco: [visionzerosf.org](http://visionzerosf.org)

**Resources:**

- Silicon Valley Bicycle Coalition, Vision Zero Toolkit: [bikesiliconvalley.org/files/150820-SVBC-CalWalks-Vision-Zero-Toolkit.pdf](http://bikesiliconvalley.org/files/150820-SVBC-CalWalks-Vision-Zero-Toolkit.pdf)
- Vision Zero Network: [visionzeronetwork.org](http://visionzeronetwork.org)

*Complete Streets Policy*

Complete streets policies, or Great Streets in El Paso, aim to develop integrated, connected networks of streets that are safe and accessible for all people, regardless of ability, income, or chosen mode of travel. Complete streets make walking and bicycling convenient by



*Figure 58. An example of a complete street from the Walk.Bike.NC complete streets program in Raleigh, North Carolina*

increasing access to employment centers, commerce, and educational institutions; and allow greater choice in transportation options that help to reduce transportation costs for residents. Complete streets policies are holistic. This means that rather than just focusing on the physical changes of streets, complete streets aim to inform transportation planning, design, maintenance, and funding decisions.

Successful policies are those that incorporate the thoughts and opinions of a broad group of stakeholders: transportation planners and engineers, elected officials, transit agencies, public health departments, and members of the community. Complete streets can be achieved through a variety of policies:

- Ordinances and resolutions
- Rewrites of design manuals
- Inclusion in comprehensive plans
- Internal policies developed by transportation agencies
- Executive orders from elected officials, such as mayors or governors
- Policies developed by stakeholders from the community and agency staff that are formally adopted by an elected board of officials

**Resources:**

- Complete Streets Policy Development 101 Presentation: [smartgrowthamerica.org/](http://smartgrowthamerica.org/)

complete-streets/changing-policy/policy-elements

- Smart Growth for America, Complete Streets Local Policy Workbook: [smartgrowthamerica.org/documents/cs/resources/cs-policyworkbook.pdf](http://smartgrowthamerica.org/documents/cs/resources/cs-policyworkbook.pdf)
- National Complete Streets Coalition, Elements of an Ideal Complete Street Policy: [smartgrowthamerica.org/documents/cs/policy/cs-policyelements.pdf](http://smartgrowthamerica.org/documents/cs/policy/cs-policyelements.pdf)
- Taking Action on Complete Streets: Implementing processes for safe, multimodal streets: [smartgrowthamerica.org/documents/cs/impl/taking-action-on-cs.pdf](http://smartgrowthamerica.org/documents/cs/impl/taking-action-on-cs.pdf)
- National Complete Streets Coalition, The Best Complete Streets Policies of 2015:
- <http://www.smartgrowthamerica.org/documents/best-cs-policies-of-2015.pdf>

#### *Annual Bicycle and Pedestrian Counts*

The City should conduct annual bicycle and pedestrian counts as a mechanism for tracking bicycling and walking trends over time and for evaluating the impact of infrastructure projects, policies, and programs. This will allow the City to evaluate the success of initiatives aimed at increasing ridership and physical activity. At a minimum, this program should tally the number of bicyclists and pedestrians at key locations around the City. The same locations should be counted in the same manner annually. This will provide the City with information about the growth of bicycle ridership and pedestrian usage of facilities, determine where improvements need to be made, assess who is using the facilities, and provide a dataset to accompany grant applications. It is recommended



**Figure 59.** A volunteer performs manual counts of a trail.

that the City perform and/or coordinate these annual trail counts. The Bicycle/Pedestrian Coordinator should handle tracking, analysis, and reporting. Counts can be done manually by staff or volunteers, or by using video or a variety of other technologies.

The National Bicycle and Pedestrian Documentation Project has developed a recommended methodology, survey and count forms, and reporting forms for this type of effort.

#### **Sample Programs:**

- Oregon Metro, Portland, OR: [oregonmetro.gov/how-metro-works/volunteer-opportunities/trail-counts](http://oregonmetro.gov/how-metro-works/volunteer-opportunities/trail-counts)
- City of Vancouver, WA: [cityofvancouver.us/parksrec/page/annual-trail-user-count](http://cityofvancouver.us/parksrec/page/annual-trail-user-count)
- Resources:
- National Bicycle & Pedestrian Documentation Project [bikepeddocumentation.org](http://bikepeddocumentation.org)
- The National Cooperative Highway Research Program (NCHRP) Guidebook on Pedestrian and Bicycle Volume Data Collection: [onlinepubs.trb.org/onlinepubs/nchrp/nchrp\\_rpt\\_797.pdf](http://onlinepubs.trb.org/onlinepubs/nchrp/nchrp_rpt_797.pdf)
- Innovations in Bicycle and Pedestrian Counts: A Review of Emerging Technologies: [altaplanning.com/wp-content/uploads/Innovative-Ped-and-Bike-Counts-White-Paper\\_Alta-Planning-Design.pdf](http://altaplanning.com/wp-content/uploads/Innovative-Ped-and-Bike-Counts-White-Paper_Alta-Planning-Design.pdf)

#### **Programs that Promote Safety**

##### *Safe Routes to School*

Safe Routes to School (SRTS) programs use a “5 Es” approach that integrates Engineering, Education, Enforcement, Encouragement, and Evaluation strategies to improve safety and encourage children walking and biking to school. SRTS works to provide youth with the opportunity to ride or walk to school, parks, a friend’s house, or to the library. Programs educate youth and parents about safe bicycling skills, encourage schools and communities to support bicycling and walking, and help communities make the streets, trails, and sidewalks safe for bike riders of all ages. The programs are usually run by a coalition of city governments, schools, school district officials and teachers, parents and students, and neighbors.

The City should develop and implement a city-wide SRTS initiative to help schools start programs or sustain and enhance existing efforts. This involves assessing needs and identifying opportunities, collecting data, and convening an advisory committee to guide the City's initiative.

SRTS programs provide the opportunity to educate and encourage both parents and students about active transportation, health, and safety through custom materials and events.

Outreach events and programs that educate and support bicycle and pedestrian facilities include:

- Walk/Bike to school day
- Bike Safety Education class/bike rodeo
- Bike to school challenge
- Walking school buses
- Bicycle trainings and clinics
- Free bike helmet giveaways
- Speed and crosswalk enforcement near schools
- Educational materials for parents

BikeTexas has developed an extensive guide to organizing biking and walking events at local schools. The Safe Routes to School Event Handbook ([biketexas.org/en/education/educational-resources/safe-route-to-school-event-handbook](http://biketexas.org/en/education/educational-resources/safe-route-to-school-event-handbook)) provides all the steps of organizing events. The handbook offers materials in both Spanish and English, and guidance on the following:



Figure 60. Students travel to school in a walking school bus during a SRTS event.

- Planning and Promotion
- General Event Materials
- Bike/Walk to School Day
- Bike/Walk-A-Thon
- Bike/Walk Rodeo

Bike Texas also provides additional resources under the SafeCyclists Teacher Master Pages. This curriculum includes information and resources on implementing bicycle safety education in schools. While these materials are targeted at children and youth, many of these materials can also be used during outreach or at events as educational handouts. Some materials that can function as additional education materials include the following:

- Share the Road Guidelines
- Vehicle (bicycle) Safety Inspection Checklist
- Helmet Sizing and Adjustment Handout
- How to Fix a Flat Handout

#### Resources:

- National Center for Safe Routes to School [saferoutesinfo.org](http://saferoutesinfo.org)
- Safe Routes Texas: [txsaferoutes.org](http://txsaferoutes.org)
- Bike Rodeo Manual: [saferoutestoschools.org/pdfs/lessonplans/RodeoManualJune2006.pdf](http://saferoutestoschools.org/pdfs/lessonplans/RodeoManualJune2006.pdf)

#### *Driver and Bicyclist Education Media Campaign*

A high-profile media campaign can help to normalize bicycling as a valid transportation option, encourage bicycling, discourage unsafe behaviors of road users, and promote the City's investment in improved and safe transportation infrastructure.

As identified by the City and BAC, there is a need for a campaign that address unsafe and illegal behaviors and attitudes of both motorists and bicyclists, while encouraging mutual respect among all road users and encouraging bicycling. Campaigns can be customized with a variety of messages, target audiences, and outreach methods. A marketing campaign that highlights bicyclist safety is an important part of helping all road users—including both motorists and bicyclists—understand their roles and responsibilities on El Paso roads. Benefits of such a campaign include:



- Promoting bicycling as a positive and accepted form of transportation
- Increasing awareness of bicyclists on the road
- Improving road user behavior and compliance with traffic safety laws

A well-produced campaign will be memorable and effective and include clean, clear graphics in a variety of media. Effective campaigns are those that use positive, reinforcing messaging and graphics, as opposed to shaming or frightening any type of road user. Bicycling campaigns can utilize a variety of media outlets, including billboards; print advertising; transit vehicles, stations, or shelters; informational brochures or handbills; web ads and social media; and branded promotional items.

Before launching a campaign, it is recommended that the City develop a set of campaign goals that identify the problem behavior(s), desired outcomes, and the target audience. This will inform the campaign messaging and imagery. A stakeholder or focus group should be convened with individuals familiar with the community to ensure that the campaign messages and graphics will resonate with the target audience. The audience will

also determine what types of media are utilized, but it is recommended that a variety of outlets be used to ensure coverage, reach, and repetition.

**Sample Program:**

- Bike PGH, Pittsburgh, PA: [bikepgh.org/care](http://bikepgh.org/care)
- New York City Department of Transportation, LOOK Campaign: [nyc.gov/html/dot/html/pr2012/pr12\\_46.shtml](http://nyc.gov/html/dot/html/pr2012/pr12_46.shtml)
- Los Angeles Metro, Every Lane is a Bike Lane Campaign: [thesource.metro.net/2013/03/04/share-the-road-its-the-law/13-1362\\_otd\\_bike\\_traffic\\_safety\\_30sheet\\_jl\\_lo/](http://thesource.metro.net/2013/03/04/share-the-road-its-the-law/13-1362_otd_bike_traffic_safety_30sheet_jl_lo/)

**Available Materials and Resources**

To help launch a new program or to support bicycle education, there are many low-cost or free resources the City can obtain to help encourage safe bicycling in El Paso. Below is a list of digital resources that can be printed as outreach/education materials or used on the City’s website or social media outlets.

- 10 Myths About Women & Cycling Poster
- League of American Bicycles
- Price: Free



Figure 61. A People for Bikes ad campaign shows a variety of bicyclists.



- Language(s): English
- [issuu.com/bikeleague/docs/womens\\_bike\\_report\\_infographic\\_11x1/1?e=1335002/5777701](http://issuu.com/bikeleague/docs/womens_bike_report_infographic_11x1/1?e=1335002/5777701)

The myths poster debunks many of the myths about women and cycling. This poster can be used at outreach events or distributed to surrounding workplaces and organization to encourage more women to bicycle.

- Bike Rodeo Manual
- Safe Routes to School Marin County
- Price: Free
- [saferoutestoschools.org/pdfs/lessonplans/RodeoManualJune2006.pdf](http://saferoutestoschools.org/pdfs/lessonplans/RodeoManualJune2006.pdf)

The goal of a Bike Rodeo is to teach children the importance of seeing, being seen, and remaining in control at all times when riding a bike. This can be achieved through an interactive simulation of traffic situations. Bike Rodeos are a popular event at schools, but can also be incorporated into other events, such as open streets events, Kidical Mass, or even as an activity during a community event like a farmers' market. This activity should also focus on helmet usage, basic bicycle handling skills, laws and regulations. This manual provides guidance on setting up a course, communication tips, and teaching points.

- Smart Cycling videos
- League of American Bicycles
- Price: Free
- Language(s): English
- [bikeleague.org/ridesmartvideos](http://bikeleague.org/ridesmartvideos)

The Smart Cycling videos will help people learn how to ride safely, improve comfort, and provide rules of the road for bicyclists. These videos are great ways to highlight a specific topic weekly or monthly on the City's website or through social media. They may also complement existing, new, or future facility improvements. Another source for instructional videos is [drivekindridekind.org](http://drivekindridekind.org).

- Safety Materials for Hispanic Pedestrians and Bicyclist

- Federal Highway Administration (FHWA)
- Price: Free
- Language(s): English and Spanish
- [safety.fhwa.dot.gov/ped\\_bike/hispanic/materials](http://safety.fhwa.dot.gov/ped_bike/hispanic/materials)

The FHWA offers a series of flyers, posters, brochures, and radio public service announcements (PSAs) that offer Spanish and English on the same (printed) material. Available and relevant materials include:

- Bike Brochure: Explains where to ride, use of helmets, reflectors, and bike lights for visibility
- Bike Poster and Flyer: Bicyclists should keep to the right and ride with traffic. Don't assume drivers will stop for you.
- Spanish Speakers Marketing Plan: The marketing plan provides recommendations about the audience, the safety issues to be addressed, the types and format of messages, the media, and the potential methods of dissemination of the outreach materials. Also included in this marketing plan are the results of the background research conducted in the development of the marketing plan [safety.fhwa.dot.gov/ped\\_bike/hispanic/fhwasa05024](http://safety.fhwa.dot.gov/ped_bike/hispanic/fhwasa05024)

### Priority Programs

The program recommendations listed in Chapter 3 are intended to be a flexible toolkit for the City and its many partners to use to benefit cycling. The order in which programs are implemented depends greatly on when resources and staff capacity can be made available to lead them, and thus there is a certain degree of opportunism that should be used when acting on these recommendations. In focusing on the City's role; however, there are a few recommendations that address an urgent need and help to create long-term capacity and practices. Therefore, the following programs are considered the highest priority for the City to implement.

#### *Bicycle Programs Coordinator*

The Bicycle/Pedestrian Coordinator is a critical part of creating a bicycle-friendly community. In an analysis conducted by the League of American Bicyclists, they

found that 40 of the largest US cities with bicycle and pedestrian staff have higher levels of bicycling than the cities without staff. This staff position is critical to implementing and maintaining projects and programs set forth in the El Paso Bike Plan.

This dedicated staff position would oversee and coordinate bicycle planning and the implementation of the Bike Plan. Furthermore, this person would be responsible for reaching out to and coordinating efforts with partners, and acquiring funding or sponsorship to launch, enhance, and sustain City programs.

This position is vital to the success of the programs. Not only will the coordinator be responsible for securing funding, they will work closely with the BAC to build partnerships that support and sustain program efforts. The Bicycle/Pedestrian Coordinator can also focus on seeking, winning, and administering grant and foundation funding to implement the programs recommended in chapter 3.

In addition to implementing programs, job duties for this staff position may include:

- Monitoring the design and construction of bikeways and trails
- Ensuring that planning documents appropriately consider bicycling
- Serving as staff for committee meetings
- Evaluating and reporting on the implementation of this Plan

#### *Bicycle and Driver Education around New Infrastructure*

When roads change, some road users may not be sure what behavior is expected of them. This can lead to mistakes and stress. The City can help make this transition smoother by proactively educating the public about why roads are changing, and how to use them safely and successfully. The City has acknowledged that new facility education is a major component of infrastructure projects. This is demonstrated in the web and video content that was created for the installation of bike boxes and two-stage left turns for bicyclists.

As recommended earlier, a high-profile media campaign

can help to promote the City's investment in improved transportation infrastructure. These campaign(s) should speak both to bicyclists and drivers (and pedestrians, if appropriate) with specific messages about what action/behavior is expected. Outreach methods should target both drivers and bicyclists. For example, to reach bicyclists, one might distribute a hang tag distributed with all new bike sales, place temporary chalk stencils in bike paths/lanes, or host a "breakfast in the bike lane" outreach event. To reach drivers, digital outreach on Waze and Pandora, radio PSAs, and/or street banners may be more effective. The main goals of the campaign will be to increase awareness of road design changes and improving behaviors and compliance around new infrastructure.

Campaign elements should use a variety of media types and outlets to ensure coverage, reach, and repetition. All media should be available in both English and Spanish. The campaign should include the following elements:

- Website and/or newspaper advertisements
- Press release to local newspapers and media outlets
- Social media posts by the City, other agencies, and partners
- Outreach to neighborhoods, individuals, and businesses near the infrastructure improvement site
- Educational information posted online with project updates
- Educational materials for partners to distribute and to use at local events
- Posters and banners along the affected corridor, including on buses
- Variable reader boards and marquees along the corridor

#### *Bicycle and Pedestrian Annual Counts*

Annual counts are an important evaluation tool; they will allow the City to evaluate the success of program initiatives and infrastructure improvements.

This data can be used in a variety of ways to support the goals and objectives of the Bike Plan. The City can apply the count data in the following ways:

- Measuring facility usage
- Evaluating before-and-after volumes after a new facility is opened
- Counting bike volumes to quantify exposure and to identify the before-and-after safety effects of upgrading a facility
- Identifying high-priority locations for bicycle facility improvements
- Developing and calibrating multimodal travel demand models
- Increasing the City's ability to compete for transportation funding to support infrastructure and programs

Bicycle and pedestrian count data will continue to grow in importance as states and regions integrate non-motorized performance measures into their performance management programs, including performance reporting in transportation funding requirements. There are a variety of methods to conduct counts that scale from an all volunteer led effort of manual counts to automated counts with the latest in bicycle detection technology. For more information about the resources available visit the National Bicycle and Pedestrian Documentation Project (<http://bikepeddocumentation.org/>) or learn about the latest in count technologies in Alta's recent white paper (<http://altaplanning.com/resources/innovative-counting-technologies/>).

## Funding and Evaluation

### Funding

Implementation of programs is a community-wide effort that can rely upon several funding and labor resources that may include grant funding, partner and non-profit resources, foundations, and other community stakeholders. Details on funding mechanisms to consider can be found in Chapter 6, Implementation.

### Evaluation

The evaluation of the recommended programs in this chapter will vary based on the type of program and the goals of the program, and evaluation should be addressed during program planning. The funding source may also affect the data collection and analysis methods

used, and often funders will want to be involved in, or at least approve, the evaluation plan for a program they are funding. The evaluation methods found in Chapter 2, Vision and Goals, should be reviewed to determine the metrics for which the programs should be evaluated.

Beyond the level of any individual program, the City can and should evaluate the ongoing success of implementing the Bike Plan. Many communities use an annual report card and/or an online reporting tool to report back to the public about the investments they are making for bicycling, and the outcomes/outputs that follow those investments. Metrics can include the following:

- Results of annual or ongoing counts and surveys
- Ridership and mode share trends
- Progress of the citywide bicycle network
- Number of bike racks installed
- Policy changes (e.g., bike + transit policies, changed laws, funding policies)
- Number of staff
- Annual budget and funding sources
- Bicycle safety: Crash rates, thefts, overall satisfaction with bicycle safety
- Pavement quality and maintenance

### Example:

- 2011 City of Cincinnati Report Card: <http://www.cincinnati-oh.gov/bikes/linkservid/DB6EA3D5-ED05-6CC1-0B0246EFE1EAD6D5/showMeta/0/>
- LA DOT Bike Program Dashboard: <http://bike.lacity.org/>

### Partnerships

Partnerships are the foundation of robust and sustainable programs. Partners may include public agencies, community organizations and nonprofits, major employers and educational institutions, local businesses, faith-based organizations, and individuals. Building partnerships with and among these actors will improve the City's capacity to design and deliver effective programs in a coordinated manner. Partnerships can come in the form of grants, in-kind donations, volunteers, cooperative project management, staff support, grant match,

**Table 9. Potential Partners**

<b>Health</b>
Paso Del Norte Health Foundation
Providence Medical
El Paso Children’s Hospital
El Paso County Public Health
El Paso Independent School District
University Medical Center
Department of Public Health
El Paso Diabetes Association
<b>Environment</b>
Office of Resilience + Sustainability
Environmental Services Department
Eco El Paso
El Paso County Historical Society
Parks and Recreation Department
<b>Economics</b>
Economic and International Development
Local businesses
Bureau of Tourism
Destination El Paso
EPCC
The University of Texas
Transportation Options Support & Safety
Sun Metro Mass Transit
Sun Cycle-El Paso Bike Share
EPPD
Velo Paso
El Paso Bicycle Club

and general support for bicycling education and encouragement. Partnerships can help to build a culture and community that values and supports bicycling as a viable means of transportation.

There is much potential for partnerships in El Paso that represent and support many of the benefits that are associated with bicycling. Table 9 includes a short list of potential partners broadly categorized under health, environment, economics, and transportation options support and safety.

While this list is not exhaustive, it does highlight many of the existing groups and organizations that could play a role in implementing the recommended programs. It is recommended that the Bicycle/Pedestrian Coordinator be responsible for tracking, soliciting, and organizing partnerships, and identify partner funding availability and capacity to support the City’s ongoing bicycle programs.

While there are many partners listed, the City should work to build a collaborative relationship with Sun Metro Transit. Sun Metro promotes Bike+Ride; a campaign for combining bicycling and transit, which can greatly expand the range of bicycle trips. The agency has a webpage devoted to Bike+Ride, complete with information and an instructional videos to help bicyclists load and unload their bike from the rack.

Working with Sun Metro, the City could further promote the combination of bicycling and transit through promoting Bike+Ride at events, partnering with Sun Metro Staff to conduct outreach, requesting how to load your bike on the bus demonstrations at events and meetings, and partnering to promote Bike+Ride through online and social media outlets.



## Policy Recommendations

As shown in the Existing Plans and Policies summary (Appendix A), El Paso's current comprehensive plan (*Plan El Paso 2012*) has several plans and policies that could be used to promote bicycling in the city. This plan documents the existing policies, arranged into a 6 Es framework, and recommends additional targeted policies that, if implemented, could strengthen the effectiveness of a bicycle program in El Paso. The recommended additional policies are also arranged into a 6 Es framework.

According to *Plan El Paso* (page 4.56), a strategy recommended by the League of American Bicyclists for addressing community concerns is to create a 6 Es approach to bicycling. Other cities have found this approach helpful to organize their bicycling-related policy efforts. The 6 Es are:

- Engineering
- Enforcement
- Education
- Encouragement
- Equity
- Evaluation and Planning

El Paso has already adopted several supportive policies for bicycling, several of which were carried forward from prior plans. Most existing policies are related the Engineering category. Other categories—Enforcement, Education, Encouragement, Equity and Evaluation and Planning—have a few existing policies supporting them. There was only one indirect existing policy identified for the Evaluation category. Note that some policies outlined below apply to more than one category, for example, *Plan El Paso* Policy 4.9.7, which supports both Education and Encouragement. In addition, not all policies listed in Appendix A are directly actionable policies related specifically to bicycling, although all policies listed in that section could have a positive effect on bicycling in El Paso. The existing policies identified in this section are directly related to bicycling.

Infrastructure improvements can have the greatest impact on rates of bicycling; however, other cities have learned that infrastructure only takes mode shift so far

and it is other supporting that further goals to become less car dependant. The most important recommendation for this category is to determine how El Paso will enact and embody all policies that support bicycling in the City.

### Six Es Approach

#### Engineering

The category of Engineering is covered by several existing policies in *Plan El Paso*. One critical policy in *Plan El Paso* (4.1.7) is to update the design manual in Title 19 of El Paso's subdivision regulations entitled Design Standards for Construction. Because this manual is the standard for streets designed and built with new developments, the standards for compact urban areas must reflect best practices for walkable, bikeable street design. The Great Streets Corridor Plan, expected to be adopted by El Paso City Council in 2016 by resolution, includes recommended cross-sections for thoroughfares. These cross-sections are expected to be included in Title 19 as part of the Great Streets adoption process. Another *Plan El Paso* policy (4.8.8) is to train select City staff to design bikeways, and the City has already taken the initial step of hosting staff and consultant training based on guidance from the National Association of City Transportation Officials (NACTO) in March 2016.

Other policies already adopted by the City in the Engineering category are directed toward the need for coordination between departments. *Plan El Paso* Policy 4.8.3 states the City will coordinate planning, design, implementation and maintenance of bicycle improvements within the city, surrounding municipalities, El Paso County, and surrounding areas in order to effectively promote regional connectivity. Also, *Plan El Paso* Policy 4.8.4 states the City will utilize the principles described in the comprehensive plan to guide planning, design, and implementation of bicycle infrastructure in conjunction with other City plans and projects. In other cities, such as Austin, TX, and Portland, OR, coordination between City departments and between the City and other jurisdictions is greatly aided by the presence of a bicycle or bicycle and pedestrian program manager. It will be critical for El Paso to create a Bicycle and Pedestrian Coordinator

position that will be the point of contact and coordinate and direct activities related to active transportation. *Plan El Paso Policy 4.8.7* recommends the City hire exactly this person. This coordinator can help shepherd a project from the beginning of the development process through maintenance activities, identify opportunities to grow the bicycle network, and be the point person for bicycle coordination between City departments and between the City and other jurisdictions. This person would be the champion for bicycle efforts and coordinate with other City departments to ensure that the goals in the Bicycle Master Plan are met.

A final example of a need for coordination is described in *Plan El Paso Policy 4.8.11* to increase the availability of bicycle parking. Although the City has existing standards for bicycle rack type and placement, the standards are not always adhered to, and training is necessary to ensure proper types and placement of bicycle racks. A Bicycle/Pedestrian Coordinator in addition to planning staff can oversee planning efforts for redevelopment, bicycle rack purchasing and installation to ensure those existing policies and standards are enforced and meet existing and updated codes for bike parking.

The City of El Paso should carry out and enhance these documented Engineering policies by coordinating the efforts of varying disciplines such as community development, capital planning, engineering, and street construction and maintenance.

### Enforcement

*Plan El Paso Policy 4.9.2* relates to bicyclist safety. It focuses on working with the El Paso Police Department (EPPD) to increase awareness of bicycle-related traffic laws and enforcement of existing and new laws; provide on-going training for police officers regarding bicycle safety laws and issues; and maintain the number of bicycle patrol officers and consider expanding the force. Per interviews conducted with El Paso public safety representatives on December 3, 2015, and March 24, 2016, including EPPD officers and El Paso Fire Department (EPFD) professionals, there is currently a lack of general public knowledge of bicycle safety laws, including the rights and responsibilities of both bicyclists

and motorists. In addition, EPPD currently maintains a 40-officer metro unit of bicycle officers who patrol downtown and offers a 40-hour training for officers to become certified as bicycle officers. Currently, approximately 100 of 1,040 officers in the City of El Paso are certified.

It is critical for the City of El Paso to provide a regular program and follow-up documentation of training associated with law enforcement's role in enforcing traffic laws equitably for all roadway users. An example of this type of training is a program from the National Highway Traffic Safety Administration, which has published a CD-based interactive training for law enforcement officers.

There are also benefits to law enforcement providing input on bikeway signs, markings and facility types focused on expectations of vehicle operators related to markings and interaction between travel modes. Publications through the El Paso Police Department communications department can facilitate a policy of bicycling safety as more and more people choose to use the bicycle for travel.

Putting these policies into practice can enhance the safety that supports encouragement programs and implementation of new bicycling infrastructure.

### Education

Education policies in *Plan El Paso* are found under Goal 4.9: Encourage increased bicycling by promoting health, recreation, transportation, tourism opportunities, and environmental benefits. These Education policies (4.9.3, 4.9.4, 4.9.5, 4.9.6, 4.9.7, and 4.9.8) direct the City to provide educational opportunities such as the following:

- Distribute print and online versions of the bikeways map
- Maintain a bicycle programs website
- Create strategies to educate all roadway users based on the most common conflicts between bicyclists and motorists
- Host regularly scheduled trainings and public events
- Create public service announcements and educational materials
- Implement a partnership with Safe Routes to School

Educating bicyclists on how to safely navigate the city using a bicycle map can also promote tourism, as a map can integrate natural and built attractions and include text describing the City's bicycling laws. Safe Routes to School is a key Education component, as teaching children how to ride a bicycle to and from their destination will create generations of adults who know how to ride a bicycle.

These comprehensive Education policies will be put into action through the programs highlighted in this Bicycle Master Plan. No new policies are recommended under this category.

### Encouragement

Encouragement policies are also found under *Plan El Paso* Goal 4.9 (4.9.7, 4.9.9, and 4.9.11). These include using social media and traditional communication outlets to position bicycling as a viable transportation option in the city; expanding the Scenic Sundays program; and using tactical urbanism—small, strategic, temporary interventions to change the look and feel of a street—to instigate conversation about positive change in the built environment. Programs recommended in this Bicycle Master Plan include updating the City bicycle program website and maintaining and expanding the Scenic Sundays program. Policies, such as creating a partnerships with schools in Safe Routes to School programs and education in school curriculums, fit into other categories but are especially critical to Encouragement. Encouraging children to bicycle to school safely could lead to bicycling at other times as well. Implementation of *Plan El Paso* Policy 4.9.11 regarding tactical urbanism could lead to a City initiative or could drive the City to partner with local artists, architects, student groups, and other groups who have ideas around bicycling the City wishes to promote.

These existing policies, if enacted, would encourage many who wish to begin bicycling in El Paso.

### Equity

*Plan El Paso* Policy 4.9.10 states the City will develop bicycle policies and programs that address geographic, racial, ethnic, economic, environmental, and public

health disparities. The City should work interdepartmentally to document the disparities listed above in El Paso, and to use the bicycle program as one tool among many to address these disparities. One program recommended in this Bicycle Master Plan is to conduct bicycle and pedestrian counts throughout the city, which will provide data from which to base decisions on equitable programs. As a follow-up to Policy 4.9.10, the following additional policies are recommended:

The City will collect data on all projects and initiatives relative to geographic, racial, ethnic, economic, environmental, and public health disparities, and will coordinate with the teams addressing these disparities to integrate bicycling into any plans to improve outcomes.

The City will use collected data to tailor bicycle programming throughout the city, especially where needs are the greatest.

### Evaluation

Of the 6 Es, Evaluation is addressed the least in *Plan El Paso*. *Plan El Paso* Policy 4.9.1, indirectly addresses Evaluation and states the City will develop a strategy to acquire designation as a Bicycle-Friendly Community by the League of American Bicyclists by 2015. Although this date has passed, acquiring the designation remains a priority and is a goal of this Bicycle Master Plan. El Paso received an honorable mention in 2013. The application for a Bicycle-Friendly Community requires each municipality to evaluate its policies, programs, and performance regarding rates of bicycling, and is itself a comprehensive evaluation tool. However, evaluation is not stated specifically as a policy in *Plan El Paso*, and evaluation is a vital part of a complete policy or program, to let users and funders know the policy or program is working. Therefore the following policy is recommended:

The City will set performance targets relative to goals for mode shift and implementation in all elements of the plan, to track progress, identify program success, and identify the need for updates.

Progress toward the goals listed in the Bicycle Master Plan will be reported to El Paso City Council annually.

This report card will be publicized on the bicycle program website and utilize infographics directed at easy to read and understand progress milestones of plan implementation.

## Conclusion

Putting *Plan El Paso's* existing directly bicycle-related policies (4.1.7, 4.8.3, 4.8.4, 4.8.7, 4.8.8, 4.8.11, and 4.9.1-4.9.11) into action, starting with adopting the Bicycle Master Plan and funding and hiring a Bicycle/Pedestrian Coordinator, will help El Paso achieve the goals of *Plan El Paso* and this Bicycle Master Plan. Taking the 6 Es approach to defining policies will also help the City determine which categories are thriving, and which categories need additional action. While the Engineering category can have the most immediate impact on bicycling rates, when taken together, all 6 Es are important in contributing to a safer, connected bicycle network and more bicyclists of all ages on roads and trails. For this reason, three additional policies are recommended:

- Equity Category
  - The bicycle program will work with other City departments or functions that collect data on geographic, racial, ethnic, economic, environmental, and public health disparities, and will coordinate with the teams addressing these disparities to integrate bicycling into any plans to improve outcomes.
  - The City will use collected data to tailor bicycle programming throughout the city, especially where needs are the greatest.
- Evaluation Category
  - Progress toward the goals listed in the Bicycle Master Plan will be reported to El Paso City Council annually. This report will be publicized on the bicycle program website.

These additional policies will round out the 6 Es and help ensure resources are being used efficiently and wisely.



## Section 6: Implementation



## Implementation

Successful implementation of the bicycle network requires careful coordination of city departments and partner agencies and budgets. The team estimated costs for the recommended network and prioritized their implementation using a variety of criteria. This chapter outlines strategies for working between departments, outlines the recommended implementation priorities for the network, planning-level cost estimates, and identifies potential funding sources.

### Bike Network Prioritization

The City of El Paso is a public agency, responsible for the efficient, effective, and values-driven expenditure of taxpayer dollars. Non-motorized infrastructure projects and programs must compete with other capital improvements and municipal services, as well as with one another, for limited internal and external resources. In order to maximize investment and provide the greatest benefit, the City of El Paso should pursue a logical and systematic approach to prioritize non-motorized transportation infrastructure investment and plan implementation. Each link in the bikeway network, both existing and planned, has been prioritized based on criteria that reflect the Plan Goals and Objectives and incorporate input from community residents, stakeholders, and the plan steering committee. This includes recommended projects on City of El Paso roadways and TxDOT roadways, as well as off-street paths along rivers, canals, utility corridors and other open spaces.

The eight prioritization criteria are listed in Table 10, along with brief descriptions and weighting factors based on city staff and steering committee feedback. All but one criteria (weighing construction and maintenance costs) use binary scoring, so each project either meets or does not meet the criteria. For the weighing construction and maintenance costs prioritization criteria, each project receives a score along a sliding scale that corresponds to that project's recommended bicycle facility type. Projects that require less financial capital for design, construction and maintenance, such as signed shared roadways and shared lane markings, receive a higher score, while more expensive projects like protected bike lanes and shared-use paths receive a lower score. The sliding scale acknowledges the wide range of facility costs for bikeway design, construction, and maintenance.

Each segment of the bicycle network has been evaluated and scored using the criteria listed in Table 10. The resulting scores were then used to group the recommended segments into three priority levels: high, medium, and low. These levels are not intended to rigidly divide the projects into exclusive groups for the purpose of project phasing. Instead, they offer insight into which projects will provide the greatest benefit to the community and help accomplish the Plan Goals and Objectives. The high-, medium-, and low-priority projects are displayed in Map 15.

The prioritization process addresses a citywide approach to building a connected bikeway network through criteria focused on connectivity to existing and built bikeways, to close gaps in the network, as well as by implementing low stress bikeways that is at the heart of the bike plan.

While the prioritization methodology includes criteria that was identified through the process from department and public input, outside of this analysis method, there will be opportunities to build the network and those opportunities should not be missed. This does not mean building two-block segments of bikeway facilities, but rather integrating the ultimate bikeway section (without putting down the markings) with a roadway section that does not preclude the implementation plan when the segment can connect to an existing network route.

Map 15

# NETWORK PRIORITIZATION

## Legend

### Prioritization Ranking

— Low Priority

— Medium Priority

— High Priority

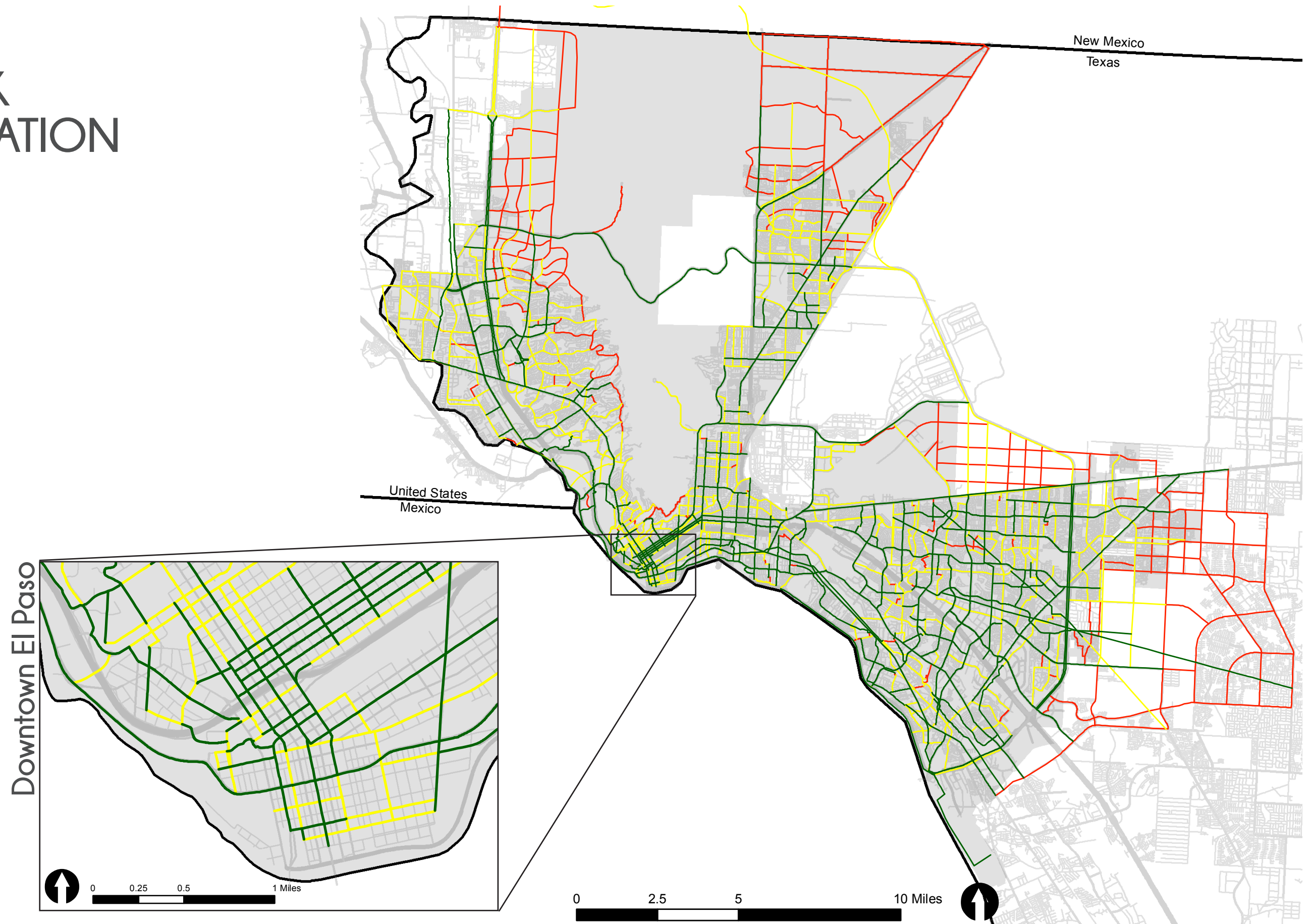

Table 10. Prioritization Criteria

Prioritization Theme	Criteria Definition	Criteria Weight
Capturing High Demand	Links people on bicycles to areas with high concentrations of residents, destinations, transit, and other important community amenities	4.82
Providing Low Stress Bikeways	The project's ability to provide a low-stress bicycle facility that welcomes people of all ages and experience levels	4.21
Linking and Expanding the Network	Directly connects to at least one existing bicycle facility	4.78
Enhancing the Bike Share System	Provides access to existing and proposed SunCycle bike share stations	2.57
Eliminating Barriers	Provides a continuous facility across major freeways like Interstate 10, US 54, and Loop 375; provides a continuous facility across or through major land use or topographical barriers such as Fort Bliss and Franklin Mountains	4.00
Weighing Construction / Maintenance Costs	Balances construction and future maintenance costs	3.35
Addressing First Mile / Last Mile Need	Provides direct access to Brio RTS, the streetcar, or a Sun Metro Bus Route	4.00
Increasing Regional Connectivity	Connects to Fort Bliss, Ciudad Juárez, Doña Ana County, and other adjacent communities	2.79

### Facility Cost Estimates

Planning-level cost estimates are an essential tool used for programming capital improvements and drafting funding applications for federal funding sources. Cost estimates were developed for each facility type based on initial planning-level examples of similar constructed projects and industry averages. These costs were then refined with the assistance of the City of El Paso CID and TxDOT staff based on local experience with unit costs in the region. All facility designs and associated cost estimates proposed in this plan are conceptual in nature and should undergo final engineering design, review and estimation in coordination with all concerned departments in order to arrive at detailed preliminary and final construction costs. Engineering costs are not included in the figure since it will be at the discretion of the City to prepare design plans in-house, or through consultant contracts.

These costs are provided in 2016 dollars and include a 20 percent contingency. Inflation should be included in

costs in future years when bikeway improvements are programmed.

The cost estimates do not include costs for corridor planning, public engagement, surveying, engineering design, right-of-way acquisition, and other work required to implement the project. Depending on the type of improvement, these additional costs can generally be estimated at up to 25 percent of the facility construction cost, in the case of a shared use path design or a two-way cycle track. Construction costs will vary based on the ultimate project scope (i.e., combination with other projects) and economic conditions at the time of construction. When combined with larger roadway projects, the city can achieve economies of scale and maximize the value of every dollar spent on transportation infrastructure.

A project cost range for each type of linear bicycle facility recommended in the Plan is listed in Table 11 below. A complete list of cost descriptions for each facility type and estimates for each individual project can be found in Appendix C of the Plan.



Table 11. Cost Estimates for Recommended Bikeway Types

Bicycle Facility Type	Miles	Cost (Low)	Cost (High)
Signed Shared Roadway	14	\$126,352	\$252,704
Shared Lane Markings	67	\$1,438,675	\$2,877,350
Bicycle Boulevard	84	\$7,092,531	\$14,185,069
Shoulder Bikeway	12	\$147,517	\$295,035
Bike Lane	157	\$15,567,032	\$31,134,061
Buffered Bike Lane	222	\$27,830,002	\$55,659,998
Cycle Track / Protected Bike Lane	44	\$17,570,846	\$35,141,711
Two-Way Cycle Track / Protected Bike Lane	8	\$3,210,449	\$6,420,903
Shared Use Path	271	\$308,008,102	\$616,016,230
Further Study Needed	60	N/A	N/A
Grand Total	938	\$380,991,506	\$761,983,061

## Maintenance

Bicyclists are vulnerable to pavement irregularities such as cracks, potholes, broken glass, sand, or gravel. Unmaintained landscaping causes safety issues by obstructing travel lanes and hindering visibility. Major storms and motor vehicle crashes can leave debris in bikeways, presenting hazards to bicyclists, which must be picked up as soon as possible.

Routine maintenance is defined as the basic level of service for a given bikeway. Routine maintenance occurs on a regular schedule and is provided to a minimum standard of quality.

Examples of routine maintenance are as follows:

- Regular street sweeping
- Trash, collision, and other debris pick-up
- Signal tuning for bicycle sensitivity
- Paved surface repairs including asphalt patching and crack sealing
- Permanent sign maintenance/lane striping maintenance (non-MUTCD required signs are considered

extraordinary maintenance)

- Maintaining landscaping/plants/trees from overgrowth and overhanging the bicycle facility

Maintenance needs are typically identified through one of three sources: riders reporting a problem, routine inspections, or special inspections after an event like a vehicle collision, major storm, or construction project. Bicyclists should be encouraged to call the City to report debris in bike lanes, improperly working facilities or traffic mechanisms, potholes, and similar problems. Performing routine inspections can result in the discovery and repair of improperly functioning facilities, which can sometimes reduce more extensive repair and replacement costs of paving materials, traffic signals, signage, and other potentially expensive equipment. When not revealed by other means, problems should be taken care of by regularly scheduled maintenance, or standard operational procedures define for roadways in general, and funded by routine maintenance budgeting.

Table 12. Recommended Bikeway Network, Annual Operation and Maintenance Cost Estimates

Facility/Program	Unit Cost	Description	Notes
Shared use path or other physically separated facilities	Varies from \$8,000 - \$17,000	Annual Cost per Mile	Lighting and debris and vegetation overgrowth removal
Bike lane or buffered bike lane	\$2,000	Annual Cost per Mile	Repainting line stripes and stencils, sign replacement as needed
Bike route or bike boulevard or other shared facilities	\$1,000	Annual Cost Per Mile	Sign and shared use stencil replacement as needed

Unit costs based on Alta Planning + Design experience with similar bikeway systems, and “Trails for the 21st Century: Planning, Design and Management Manual for Multi-Use Trails,” published by the Rails-to-Trails Conservancy, 2001.

The City should review its scheduled maintenance programs with an emphasis on bicycle facility maintenance as related to this planning effort. Service schedules should be established to avoid citizen for resolving maintenance issues.

Funding sources for maintenance are normally from operation budgets, much less choice that there are capital funding sources for implementing bicycle projects. To ensure adequate upkeep over the long term, the City should budget and prioritize dedicated sources for the maintenance of bicycle facilities. This is a challenge that most communities face, but the City of El Paso is poised to rise above this roadblock to exceptional bicycle facilities.

The total annual maintenance cost of the bicycle network will vary based on bikeways implemented. Bicycle facility maintenance costs are based on per-mile estimates, which cover labor, supplies, and amortized equipment costs for weekly trash removal, monthly sweeping, and bi-annual resurfacing and repair patrols. Other maintenance costs include restriping bike lane lines, sweeping debris, and tuning signals for bicycle sensitivity. As part of the normal roadway maintenance program, extra emphasis should be put on keeping the bike lanes and roadway shoulders clear of debris and keeping vegetation overgrowth from blocking visibility or creeping into the roadway. The other typical maintenance costs for the bikeway network include the maintenance of signage, striping, and stencils.

### Strategies for Working Between Departments

All city departments have a role to play in the implementation of the El Paso Bike Plan. It is critical that each department understand what that role is, and what tasks are required to fulfill those roles. Also, departments need to have a clear understanding of how best to coordinate activities with other departments to achieve efficiency and beneficial results that achieve plan goals and objectives, and resulting performance measures. This strategy section will serve to outline strategies and ideas of how all City Departments can get the most out of their efforts to implement the El Paso Bike Plan.

### Elected Officials (Mayor and Council)

Elected officials, including the Mayor and District Representatives, will be key to implementing the El Paso Bike Plan by providing the direct connection between the public, businesses, and city staff. Elected officials serve as the leadership of the city that enable staff to do their jobs and to make sure the plan is implemented as approved. There are numerous ways these officials are involved. Elected officials provide support through funding and giving direction for activities that range from addition of bikeways that are implemented by the CID, to maintenance of infrastructure by Streets and Maintenance, to education programs carried out by the Police Department or Parks and Recreation Department. Another key role of elected officials is to make sure the plan implementation results in expected outcomes by

reviewing progress each year through a staff report on the plan. This report will promote fiscal responsibility of efforts and benefits from budget and staff time spent. This will result in public accountability and opportunities for elected officials to share the success of implementation efforts in all facets of the plan.

### City Manager and Executive Leadership Team

The City Manager and Executive Leadership Team enable staff to go forth and take actions that achieve goals and carry out objectives. The role of the City Manager and team is to stay high level and provide the support and resources for departments to carry out the plan. The City Manager's actions will set the tone for the plan through empowerment of the executive committee and department heads. It is critical to the success of the plan that the City Manager is made aware of implementation actions so that they can be the best source of information for elected officials and be able to inform stakeholders and the public of actions and resources used for plan implementation. It is the responsibility of all departments to make sure they are proactive in communications so that there are no surprises when it comes to actions of the plan and interactions with other activities in the city.

### Capital Improvement Department

The mission of the CID is to provide capital project management services to city staff, residents, and visitors to El Paso so they can use and enjoy improved infrastructure, facilities, and amenities for enhanced health, safety, and welfare. The CID-Planning Division, which oversees the City's Transportation Planning Program and public works planning for the City of El Paso, has been the lead in the El Paso Bike Plan process and will be the lead department in carrying out the plan actions.

Since its formation in 2012, the CID-Planning Division has worked to establish bicycle planning efforts in El Paso. In 2014, the CID-Planning Division joined NACTO and led the effort to adopt the NACTO Urban Bikeway Design Guide and Urban Street Design Guide as the City's official guides for City transportation projects. The City of El Paso also created a Bicycle Advisory Committee based on the recommendations of the CID-Planning Division.

The City's first shared street for bicyclists, pedestrians, and vehicles was completed in 2013 adjacent to the new Downtown Ballpark. The CID-Planning Division adopted new median design standards, an interim bike atlas, new tree and plant list for roadways, and other planning documents in 2013. The City's first buffered bike lane was completed in 2014, and the CID-Planning Division continued to construct additional bike lanes during implementation of street reconstruction and resurfacing projects in 2015 and 2016. The City also developed several bike lanes during its oversight of the NMTP from 2015 to 2016. The Resler buffered bike lane is currently under construction, which will implement the City's first bike boxes, along with three off-street trails along River Bend, Independence, and Viscount. A new off-street trail along Robinson will begin construction in 2016. In addition, the CID-Planning Division will finalize the Great Streets Plan and an urban trails plan in 2016 and is currently developing plans for the City's first protected bicycle lanes in Downtown El Paso to be constructed in 2017.

It will be the responsibility of this department to be the champion and resource for other departments on interpretation of plan activities. While the plan provides a defined network of bikeway types on specific streets and drainage corridors, the built environment changes on a regular basis, and the plan will need to adapt to those changes. For example, a one-way street may at some point become a two-way street, and the bikeway type proposed may need to change to be most effective for the network. This change will need to be communicated to the Streets and Maintenance Department so they can weigh in on actions that they are responsible for so the plan can be adapted for both departments. The design of a bikeway, while provided in detail in the plan, should be flexible enough to capitalize on opportunities and changes in the community to be most effective in moving people. It will be the responsibility of the CID to work with other departments to provide an organized process through which the plan can be executed and change can be managed. The CID will also be the collector of information from other departments to provide annual reports on the plan progress to the City Manager, Executive

Committee and, ultimately, the elected officials. The CID will make sure costs of implementation and programs are gathered and reported along with performance measure results.

At a deeper level, the CID will take the lead role in coordination with all other departments to make sure each department knows and understands what actions are expected by them to implement the plan, the reporting required, and specific goals that are assigned to them. The CID will work with other departments to define the best practices and materials to implement the plan in the context of that department's mission and focus. For example, in the case of Streets and Maintenance, a concern they have relates to adding disconnected segments during maintenance operations or to only adding specific bikeway types to streets shown on the plan. While the plan provides specifics for the purposes of taking the next steps of conceptual design, it is important for the two departments to coordinate activities to get the right bikeway type on the right street as defined in the conceptual design or implementation stage (being a maintenance activity or construction project). This means that discussions should take place to define how a segment will be implemented and transition from an existing bikeway or to a section with no bikeway, which will be a future effort. It may also mean changing a bikeway type that could be upgraded to a more protected bikeway, or one that may need to scale back to a bikeway that will fit the roadway section. While this is not recommended, it may be necessary to maintain the network connectivity. It may also mean shifting a recommendation to a street over from that shown on the plan to take advantage of a better street for the bikeway recommended. A clear process on plan implementation and updates will need to be discussed by the departments, future Bicycle/Pedestrian Coordinator and the bikeway advisory committee so that all are on the same page.

Elements of implementation will be coordinating with other outside agencies, like Sun Metro, TxDOT and the County. Coordination of road diets and parking changes may be the first steps necessary to implement a recommendation and CID can take the lead in getting concepts

ready for the next step of funding or implementation by projects or by maintenance operations.

## Economic and International Development

The Economic and International Development Department focuses on making sure the City attracts workers, residents and businesses that continues the success that has put the city in the top 20 percent of US cities in performing economies. Active transportation including biking, walking and transit are becoming more and more, key factors in where businesses and people locate. Other departments need this department to communicate, highlight and gather information and report it accurately in marketing information and infographics. The Economic and International Development Department can assist in reporting performance measures of the bike plan related to economic reporting and growth of the economy. Reporting of economic impacts of the plan implementation and bicycling in general needs to be apparent and publicized.

## Information Technology

The City website, maps and interactive community input tools are critical for documentation and helping to move plan implementation forward. GIS data on new bikeways, bike parking, and other information critical to measuring plan progress will be key to effective and efficient reporting by and to departments and the public. This department will interact, collect and provide the tools for next steps of data needed in all facets of the plan. This department will support other departments with tools and programs as well as provide a host site for all things related to active transportation that will serve as a clearinghouse for information all departments connect to for their specific role in the plan. It will also be critical for providing an interactive microsite that can inform the plan, as well as help department operations and respond to resident needs and document when and how they are addressed.



### Office of Management and Budget

The budget and management staff of the Office of Management and Budget (OMB) develops and administers the budget process for planning, decision-making, and managing control of resources for the Mayor, City Council, and departments. The role this department will play in the bike plan will be to continually analyze the revenues that are available for implementation in addition to other city operations, appropriations of available funds, expenses associated with plan implementation, and tracking encumbrances of all departments to develop clear financial reporting of the amount spent to implement the plan. The ultimate goal is to assist other departments and track resources which are used as reporting for city officials in the City's ongoing effort to provide effective, efficient, and responsive bike plan implementation effort.

### Office of Resilience + Sustainability

The Office of Resilience + Sustainability strives to improve El Paso's ability to survive, adapt, and thrive in the face of all types of shocks or stresses. Their mission is to leverage El Paso's resilience challenges as opportunities, while reinforcing El Paso's ability to move beyond survival towards a thriving future. This office believes active and alternative transportation are key to addressing El Paso's resilience challenges, which include air quality challenges and high instances of respiratory illnesses and other preventable diseases. One of the key focus areas identified by the Office of Resilience + Sustainability in the El Paso Resilience Assessment is "Healthy City, Healthy People," which emphasizes the importance of design and infrastructure that supports walkability, bikeability, and a high quality of life. This office, along with the CID, will be a leader in implementation of the plan. There are three primary roles this office serves for the plan: one, to serve as champion for the plan by coordinating with and supporting all departments to overcome obstacles to implementation; two, to report plan progress on performance measures to elected officials and the public in an effective manner; and three, to publicize successes.

### Parks and Recreation Department

The purpose of the Parks and Recreation Department is to provide indoor and outdoor leisure services to persons of all ages so they can develop skills, socialize, experience nature, relax and live a healthier lifestyle. Programs are clearly a strength of this department and they can lead the implementation of program elements recommended in the plan, publicizing carrying out the programs and reporting results. Tracking training, results of encouragement events, and publicizing programs are key tasks in the plan.

### Planning and Inspections

The Planning and Inspections Department is committed to helping El Paso by efficiently and effectively providing direct services to El Paso's businesses, residents, visitors and development and construction community, including planning and land development, building permitting, inspection and safety, business licensing, special event permitting, and pre-development consultation assistance. Many infrastructure elements, like bike connections through new development and amenities like bike parking for new development, are key ways that the bike plan can proactively transform how the land use and transportation connections are made. It is critical that Planning and Inspections coordinate with CID and Streets and Maintenance to make sure bicycle access to new development functions with the site, roadway and bicycle network.

### Police Department

It is the mission of the EPPD to enforce the laws of the community and to work in partnership with the community to enhance the quality of life in the City of El Paso. This department will have a key role of encouraging safe behavior and interaction between motorists and bicyclists, as well as providing safety training and education for safe interaction between all modes of travel. As ambassadors for safety in the community, EPPD can champion safe streets for everyone that can include providing education on signs and pavement markings that are a part of implementing the bike network. The Police Department can make sure public information

is offered showing the bikeway types that will be implemented and how users are expected to react to these bikeways both from a motorist perspective and a bicyclist perspective. Coordination between the CID and Police Department is critical for information to be coordinated and consistent. Interaction between this department and both CID and Streets and Maintenance are key so that the Police Department knows when and where new bikeways are implemented and enforcement patrols should be enhanced.

### Public Health

Communication of the benefits of the plan to the public on an annual basis is critical as being one of many benefits to the city. This department will be critical to providing information to all departments on the health benefit goals and performance measures met from the goals and objectives that the plan sets to achieve.

### Purchasing and Strategic Sourcing

The Purchasing & Strategic Sourcing Department is the primary agency responsible for purchasing and e-sourcing matters for supplies and services necessary for the efficient operation of all City departments. The Purchasing & Strategic Sourcing Department will need to work jointly with the various City departments in developing bid specifications, scopes of work and is responsible for facilitating the bidding and contract awarding process. This is a key role in the plan so that the plan is implemented as expected from all perspectives and the right materials are used that the city can maintain.

### Streets and Maintenance

The Streets and Maintenance Department (SAM) provides the City of El Paso with street infrastructure maintenance and traffic engineering services designed to enhance and sustain the community's comprehensive transportation network. Other responsibilities include maintaining the City's fleet and facilities. All bike lane facility implementation will require CID and SAM coordination. This department has a great opportunity to implement the plan, but in budgeting, has to be supported and provided with the resources to maintain

the bikeway infrastructure as planned and initially implemented. Coordination between SAM, CID, Planning and Inspections and Information Technology (GIS updates) is critical. Coordination of segment implementation and interpretation of the network are also critical between this department and others to make sure the network growth is logical and understandable.

Materials used in the implementation is a critical point of communication between CID and SAM. Putting the right type of marking, in the right material, in the right location is critical to success of the department for implementing the bike plan, as well as for public safety and application of national best practices. Additionally, maintenance of a smooth, clear, swept path of travel for all bikeways is critical to the success and safe use of each bicycle facility.

### Funding Sources

Funding bicycle capital projects and supporting programs will require a diverse and creative approach. While federally funded grants are critical for implementing big capital projects, the city should remain flexible and creative to capitalize on partnerships, in-kind matches, and other non-traditional opportunities to implement the Plan. The following section of this chapter provides an overview of funding sources that should be utilized.

#### Federal Funding Sources

The federal government has numerous programs and funding mechanisms to support bicycle and pedestrian projects, most of which are administered by the US Department of Transportation in cooperation with state and regional entities. The following federal programs are made available to local communities in Texas through state and regional entities, including TxDOT, Texas Department of Parks and Wildlife, the EPMPO.

## Fixing America's Surface Transportation Act

Congress passed a five-year transportation bill in 2015 called the Fixing America's Surface Transportation (FAST) Act. The FAST Act provides funding for eligible bicycle projects through multiple funding programs already in existence in prior federal transportation bills. Bicycle project eligibility typically requires a local match of at least 20 percent as well as meeting federal design standards. The FAST Act now recognizes NACTO design guidelines in addition to AASHTO and state design standards for bicycle facilities, providing cities with added flexibility for the design of projects.

## Surface Transportation Block Grant Program

The FAST Act replaced the Transportation Alternatives Program (TAP) funding with a set-aside of funds under the Surface Transportation Block Grant Program (STBG). The Federal Highway Administration (FHWA) will refer to these funds as the TA Set-Aside. Eligible activities and projects include on- and off-road pedestrian and bicycle facilities, infrastructure projects improving access to public transportation and enhanced mobility, community improvement activities, and environmental mitigation; recreational trails projects, safe routes to school projects, and projects for planning, designing, or constructing boulevards or other roadways largely in the right-of-way of former divided highways.

## Congestion Mitigation and Air Quality Improvement (CMAQ)

CMAQ funds transportation projects to reduce ozone and carbon monoxide pollution and meet national ambient area air quality standards (NAAQS) in Clean Air Act non-attainment areas. The construction of pedestrian and bicycle facilities using CMAQ funding must explicitly provide a transportation function. CMAQ can provide funds for projects that bring sidewalks into compliance with the Americans with Disabilities Act (ADA). Non-construction projects such as printed materials related to safe walking are eligible for CMAQ funds as well. These projects must be geared towards walking primarily for transportation rather than recreation and must be included in a plan developed by the State and each Metropolitan Planning Organization.

## Highway Safety Improvement Program

The Highway Safety Improvement Program (HSIP) is intended to achieve significant reduction in traffic fatalities and serious injuries on all public roads by funding projects, strategies and activities consistent with a state's Strategic Highway Safety Plan (SHSP).

## Section 402 State and Community Highway Safety Grant Program

Section 402 funds can be used to develop education, enforcement and research programs designed to reduce traffic crashes, deaths, severity of crashes, and property damage. Eligible program areas include reducing impaired driving, reducing speeding, encouraging the use of occupant protection, improving motorcycle safety, and improving bicycle and pedestrian safety. Examples of bicycle and pedestrian safety programs funded by Section 402 are comprehensive school-based pedestrian and bike safety education programs, helmet distribution programs, pedestrian safety programs for older adults, and general community information and awareness programs.

## Section 405 National Priority Safety Programs

The National Highway Traffic Safety Administration Section 405 National Priority Safety Program provides funding related to bicycle and pedestrian projects for law enforcement training programs, safety enforcement campaigns and education and awareness campaigns. These funds are eligible to states where bicycle and pedestrian fatalities exceed 15 percent of overall traffic fatalities. Texas is eligible to receive these funds.

## TIGER Discretionary Grants Program

The Department of Transportation's Transportation Investment Generating Economic Recovery (TIGER) Discretionary Grants Program was created as part of the American Recovery and Reinvestment Act of 2009 with the purpose of funding road, rail, transit and port projects that achieve critical national objectives, including livability, economic competitiveness, environmental sustainability, and safety. More than \$500M was made available in FY 2014. Seventy-two applications were

funded, many of which focused or incorporated active transportation elements. One grant recipient was the North Central Texas Council of Governments, whose Land Use-Transportation Connections to Sustainable Schools project was awarded \$210,000 to create a structured dialogue to improve transportation safety and multi-modal transportation options to schools. Awards ranged from \$125,000 to \$25M.

### Land and Water Conservation Fund (LWCF)

The goal of the Land and Water Conservation Fund is the creation and maintenance of high-quality recreation resources through the acquisition and development of public outdoor recreation areas and facilities. The program operates on a reimbursing basis. The local sponsor matches 50 percent of the project cost prior to applying for the grant. After the project is approved, the sponsoring park and recreation board receives a reimbursement of 50 percent of the actual project costs. Applicants must submit a bill to the grant coordinator to request the federal share of the cost throughout the grant term.

### Community Development Block Grant Program (CDBG)

While not traditionally viewed as a source of funding for bicycle and pedestrian projects, the Community Development Block Grant (CDBG) program provides money for streetscape revitalization and other improvements that can enhance walking and bicycling. Federal Community Development Block Grant grantees may “use Community Development Block Grants funds for activities that include, but are not limited to: acquiring real property; reconstructing or rehabilitating housing and other property; building public facilities and improvements, such as streets, sidewalks, community and senior citizen centers and recreational facilities; paying for planning and administrative expenses, such as costs related to developing a consolidated plan and managing Community Development Block Grants funds; provide public services for youths, seniors, or the disabled; and initiatives such as neighborhood watch programs.”

### Department of Defense Office of Economic Adjustment Community Investment

The Office of Economic Adjustment (OEA) has a Community Investment program that provides funding for programs and projects that support the public schools that are on a military base and the roads surrounding them. This funding might be applicable to a Safe Route to School effort for a school serving Fort Bliss.

### State Funding Sources

#### Texas Parks and Wildlife’s Recreation Grants

The Texas Parks and Wildlife Department provides local agencies and organizations with a variety of funding sources to develop places and programs that support recreation activities and connect Texans to the state’s diverse and abundant natural resources. The Outdoor and Indoor Recreation Grants each provide a 50 percent funding match for local units of governments to acquire and develop parkland, renovate existing public recreation areas, and construct recreation centers, nature centers, and other park facilities.

### Local Funding Sources

While state and federal funding sources for bicycle and pedestrian projects and programs continue to be in short supply and high demand, local funds can often be the most reliable funding source to get a project done or develop an encouragement or education program. In addition, local funding is often required as match for external funding sources.

### Capital Improvement Program

As with most cities, El Paso has limited funds with which to implement bicycle and pedestrian projects and programs. By creating a dedicated set-aside in the Capital Improvement Program, the City can focus, prioritize, and plan for capital expenditures for trails, on-street bikeways, and other projects that improve conditions for walking and bicycling. This set-aside may also be used as a local match for external funding sources, or as contributory towards bicycle and pedestrian elements of larger projects. Dedicated funding sources for supporting education and encouragement programs could also be



established within the other city budgets such as those for public safety, facility development and maintenance, and parks and recreation.

Additionally the city can, and does, utilize bond funding for both Capital Improvement projects as well as Quality of Life projects.

### Impact Fees

Local governments in the State of Texas may adopt local ordinances imposing an impact fee on new development within their jurisdiction in order to fund infrastructure improvements that support development and the community at-large, including parks, recreational facilities, roads, bridges, water treatment and distribution facilities, and drainage control.

### Special Districts

In 1987, the State of Texas passed into law the Public Improvement District Assessment Act, which allows counties and municipalities to levy and collect special assessments in order to finance public infrastructure to promote economic growth and development. A Public Improvement District can be established for the construction of street and sidewalk improvements; park, recreation and cultural improvements; the creation of pedestrian malls; public safety and security; landscaping and aesthetic improvements; and a host of other capital projects.

Additionally a city can create special districts called Municipal Management Districts, Tax Increment Reinvestment Zones, Parking Benefit Districts and Transportation Reinvestment Zone. Each of these districts can serve as a financing tool to support improvements through bonds, taxes, assessments, impact fees or other funds.

### Charitable Grants from Local Foundations

Local foundations supporting health, well-being, or quality of life issues are important sources of funding, especially for smaller programmatic funding which can be harder to obtain through traditional grant funding mechanisms.

Paso Del Norte Health Foundation supports health, education, Economic and International Development Department and quality of life in the Paso Del Norte region. Additionally, the Hunt Family Foundation provides funding for quality of life initiatives in the primary geographic areas of the El Paso area. The Union Pacific Community-Based Grant Program is a foundation that provides funding to nonprofit organizations (501(c)(3)) to improve and enrich the general quality of life in the community. El Paso is located on Union Pacific Railroad lines, and therefore a local nonprofit is eligible for funding. The El Paso Community Foundation and The Cardwell Foundation provide funding for a variety of philanthropic projects in the El Paso region.

## Appendix A: Existing Plans and Policies Summary

## Existing Plans and Policies Summary

The City of El Paso and its partners throughout the region have made great strides to advance bicycling as a viable mode of transportation. This progress is built on a foundation of transformative plans and policies intentionally designed to increase active transportation and create a transportation system that accommodates the diverse values, needs, and aspirations of the community. This plan documents these plans and policies in order to establish a context for the development of the 2016 Bicycle Plan and Program efforts. Relevant plans and policies are summarized below in chronological order.

### Comprehensive Bikeway Plan for El Paso (1982)

By the late 1970s, the growing interest in bicycling for both recreation and transportation had become a priority for the City of El Paso. City staff formally considered the need for bicycle-supportive infrastructure for the first time in 1977. In 1980, the El Paso City Council passed an ordinance creating the El Paso Bikeway Advisory Board and tasked the new board with overseeing the development and implementation of a comprehensive bikeway plan. Their work led to the creation and adoption of the Comprehensive Bikeway Plan for El Paso in 1982, the region's first document to provide a holistic vision and framework for bikeway network development and supporting programs. In addition to recommendations for bike lanes along existing and planned arterials, the plan also addresses bicycle paths for recreational riding, bicycle parking, safety education, and encouragement events and materials.

### Regional Bikeways Plan Study (1997)

While never officially adopted by the City of El Paso, the 1997 Regional Bikeways Plan Study provides a snapshot of the City's efforts and approach to developing a regional bikeway network during the mid- to late-1990s. This robust document provides specific recommendations for shared use paths, bicycle lanes, bicycle routes, in accordance with prevailing design standards and facility classifications at the time. Unlike the previous plan

from 1982, this study incorporated a significant level of roadway analysis, including bicycle level of service and bicycle level of stress, in order to evaluate existing and planned bikeway facilities. Significant elements of the plan are described in greater detail below.

### Vision, Goals and Objectives

The vision, goals and objectives in the Regional Bikeways Plan Study represent the shared values of project stakeholders and the larger community, and provide a framework for the development of physical improvements and supporting programs to establish and encourage bicycling as a viable transportation option for El Pasoans.

#### Plan Vision

Although the plan vision is located at the very end of the document, its importance should not be understated. This vision encapsulates the sentiment of the community for bicycling:

"El Pasoans envision the day when they will be able to bicycle safely, conveniently, and pleasurably to all destinations within five miles of their homes. All streets and roads will be "bicycle-friendly" and well-designed to accommodate both motorized and non-motorized modes of transportation."

#### Plan Goals

The plan goals are intended to provide direction and guidance to the City of El Paso and its regional partners, including TxDOT and the EPMPO. Each goal is followed by a series of objectives aimed at achieving that particular goal:

1. To progress toward a functional bicycle system that will enable safe bicycle transportation throughout the El Paso Urban Transportation Study (EPUTS area and connect popular destinations.
2. To discourage motorists and bicyclists from committing moving violations that compromise public safety.
3. To increase levels of bicycling for commuting and utilitarian trips as a cost-effective and efficient alternative in the transportation system.
4. To teach bicyclists good riding habits and advanced

skills, and to promote the concept of “sharing the road” between bicyclists and motorists.

5. To consider bicycle and pedestrian facilities for all infrastructure projects and coordinate efforts among various public sector departments.
6. To provide bicycle storage and parking facilities at common bicycle destinations.
7. To incorporate bicycle and pedestrian-friendly concepts in residential subdivisions and avoid costly retrofitting in the future.

### Plan Phasing and Implementation

The recommendations in the plan were suggested in a manner that incorporates capital projects, policy changes, and education, encouragement, and enforcement programs into a holistic implementation schedule, as shown below. This implementation schedule provided a ten-year time frame for El Paso and its partners to transform the City into a bicycle-friendly community. The plan even noted the importance of budgeting for capital

improvements, highlighting projects budgeted in the EPMPPO Transportation Improvement Program (TIP) for federal funding and acknowledging the TIP and its associated federal funding sources as important vehicles for financing bikeway projects. While many of these recommendations included in the plan were not implemented, the City and its partners laid the foundation for establishing a regional bicycle network.

### Parks, Recreation and Open Space Master Plan (2006)

The City of El Paso’s Parks, Recreation and Open Space Master Plan (“Parks Plan”) provides a long-range vision and supporting goals to enhance the City’s recreation and open space amenities. The Parks Plan includes recommendations for every aspect of parks, recreation and open spaces, including land acquisition, facility development, recreation centers, recreation programming, trail opportunities, open space preservation, and even governance of structure and policies. The following

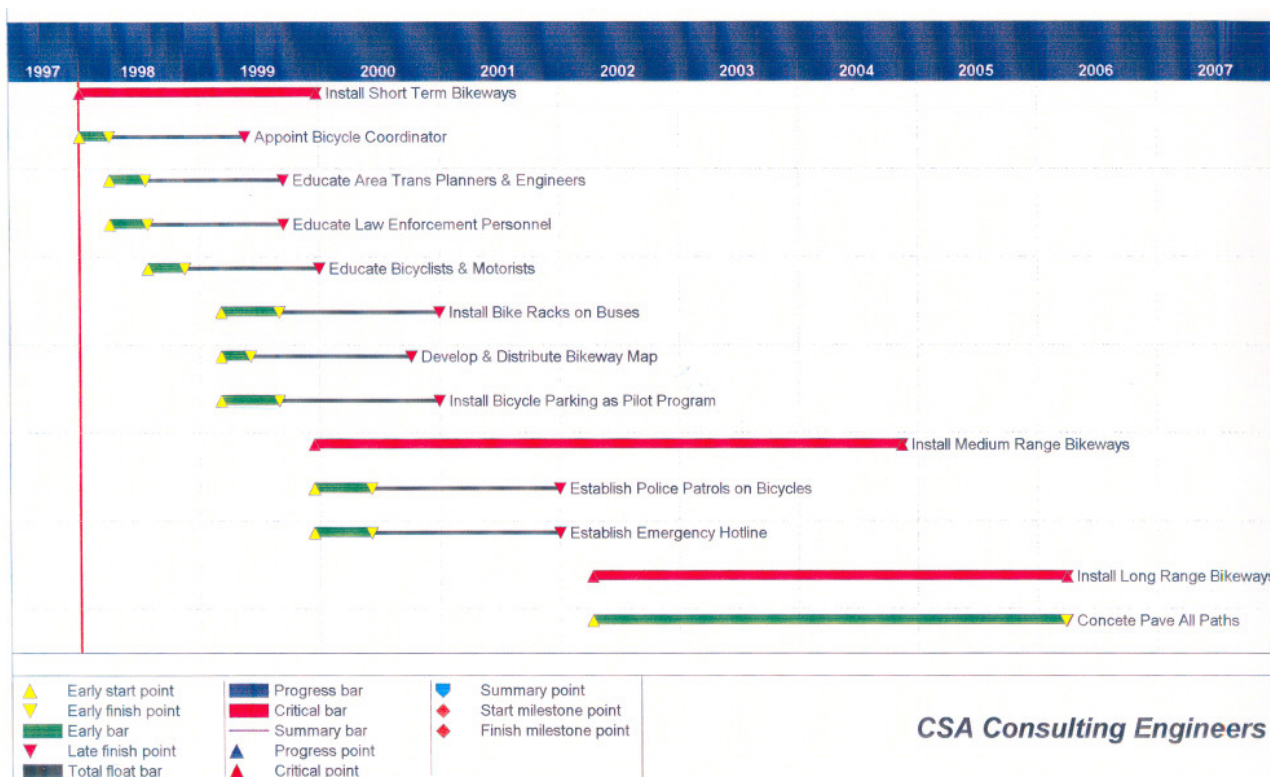

Figure A1. Ten-year implementation schedule reproduced from the Regional Bikeways Study Plan (1997)



principles create a framework for the Parks Plan's recommendations:

1. The parks system will be accessible.
2. The system will be well funded, and will actively pursue partnership opportunities.
3. The system will identify and focus first on "core" services.
4. Parks in El Paso will be extraordinary and timeless.
5. Parks will be community focal points.
6. The City will focus on connectivity and linkage.
7. The City will value and preserve open space.
8. Detention and drainage will be used as a green opportunity.
9. The system will focus on sustainability.
10. The system will focus on reducing maintenance.

Increasing connectivity and linkages, creating extraordinary and timeless facilities, focusing on sustainability, and other key principles directly correspond to trail development for bicycling and walking. The connectivity and linkage principle, in particular, is extremely relevant to the current El Paso Bicycle Plan and Program initiative. The Parks Plan notes that trails and linear parks "will equally focus on connectivity and leisure uses – the trail system will actually link a variety of uses, especially neighborhoods to area schools and parks, to retail and centers of government, and to indoor recreation."

### Trails and Open Spaces

Chapter 8: Trails and Open Spaces provides valuable context for the El Paso Bicycle Plan and Program. Included in this chapter are an inventory of existing trail facilities, a summary of trail needs, potential trail opportunities, a list of recommended trail facilities, and goals to guide trail development as a valuable component of the park system. The chapter emphasizes that trails are more than simply recreational amenities within parks, similar to a basketball court or a playground. More importantly, trails are also extensions of the park system itself, increasing connectivity between parks and to other destinations. This latter type of trail is the focus of this chapter.

### Inventory of Existing Trails

Hiking, walking and bicycling trails are few and far between in El Paso, and there is a high demand for these facilities. At the time the plan was written, there were only 17 miles of existing or funded trails in El Paso. Based on a target level of one mile of trail for every 10,000 residents, the City of El Paso is only providing 27 percent of the target level of trail miles. An additional 46 miles of trails would be needed to meet this target level.

### Trail System Goals

The Parks Plan identified seven goals pertaining to the development of a citywide trail system in El Paso. These goals are taken into account as the Bicycle Plan and Program is developed in order to build continuity and overlap between these planning efforts. These seven goals are:

1. Plan a system that can be developed in increments by many different entities, but that ultimately will interconnect into a citywide network.
2. Increase the level of understanding of the importance and value of trails and greenways, and to encourage the stewardship of natural and cultural resources.
3. Provide a framework for coordinated development of trails throughout the city.
4. Enhance the quality of life for citizens of El Paso by providing additional recreational facilities.
5. Provide access to trail corridors for all parts of the city and all residents of El Paso.
6. Create and enhance a strong sense of identity for El Paso as the trail system is developed.
7. Provide access to as many community facilities, such as schools, civic facilities, retail, and employment establishments as is possible.

### Recommended Trails

The Plan envisioned trails as an integral component of the parks and recreation system, connecting people to parks and other key destinations throughout the City in the years to come. The Plan recommends 28-30 miles of trails across the City's five planning areas, with an estimated cost of roughly \$29.5 M. In four of the five

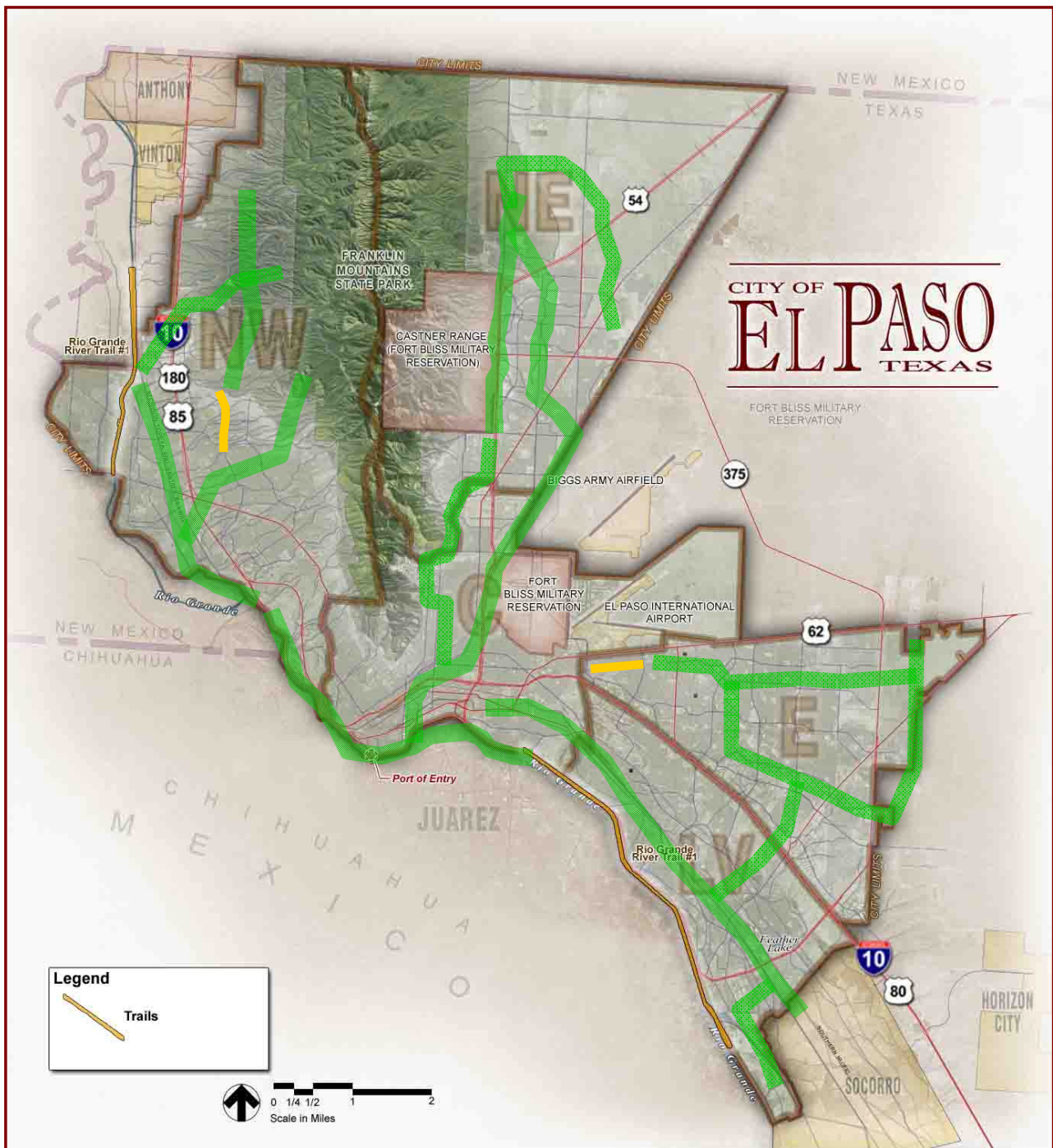

Figure A2. Recommended trail corridors reproduced from the Parks, Recreation and Open Spaces Plan (2006)

planning areas, trails are listed as the first or second most important facility need. Recommended trails are diverse in geography, character and context, utilizing levees along the Rio Grande and irrigation corridors, utility easements, drainage channels, roadway corridors, and even open desert areas. In many cases, these trails

and linear parks will require inter-agency coordination, granting of easements, and other collaborative actions to achieve success.

## Design Standards for Construction (2008)

The City of El Paso's Design Standards for Construction supplement Title 19: Subdivision Regulations of the El Paso City Code with additional design details for subdivision improvements, drainage structures, streets, sidewalks, erosion control, and other capital improvements. These regulations, officially adopted in 2011, guide the City of El Paso's Planning and Inspections

Department and Capital Improvement Department (CID) and private developers in providing consistent, high-quality public facilities to support adjacent development. The Livable City Sustainability Plan provides additional guidance for El Paso's transportation system development. While the Sustainability Plan focuses on public transit goals, particularly related to the fleet itself, the Design Standards for Construction utilize a more multi-modal approach.

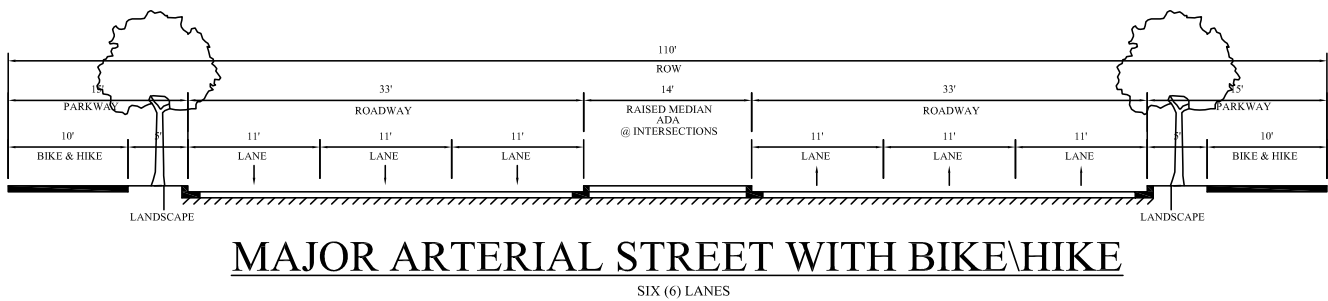

Figure A3. Recommended cross section for arterial roadway reproduced from the Design Standards for Construction

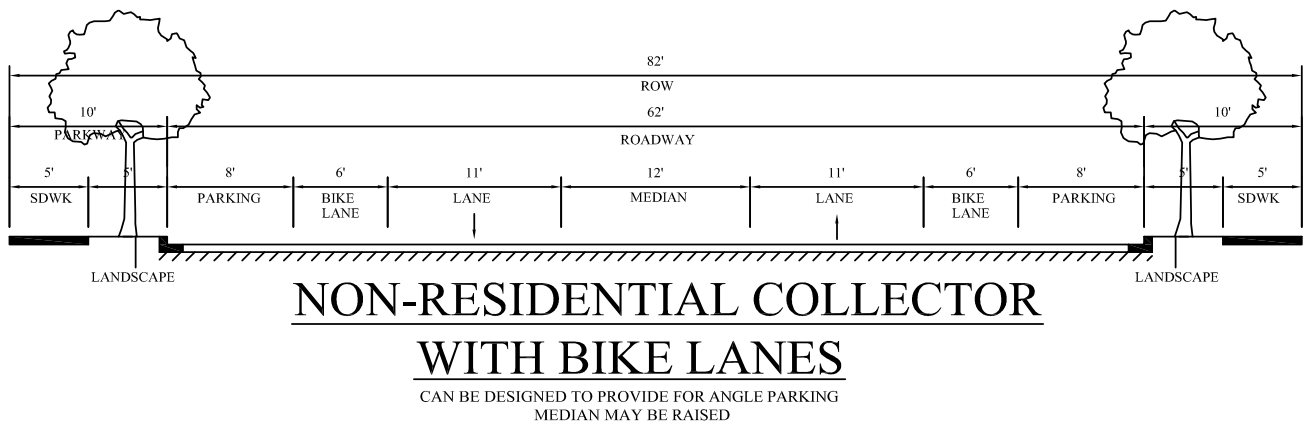

Figure A4. Recommended cross section for collector roadway reproduced from the Design Standards for Construction

### Section 3: Streets

The City's progressive street design standards incorporate bicycle facilities as a matter of practice, to be the referenced and utilized for construction of new roadways or rehabilitation of existing roadways identified in city or regional plans for the inclusion of bicycle facilities. Numerous cross sections in the design standards document incorporate bicycle lanes and/or 10' shared use paths ("hike & bike paths").

### Section 10: Traffic Calming

The traffic-calming section of the Design Standards for Construction offer a variety of tools to reduce motor vehicle speeds, divert through traffic on low-volume residential streets, and create a more comfortable environment for both bicyclists and pedestrians. Details for bulb-outs, chokers, diagonal diverters, half closures, pedestrian refuge islands, traffic circles, speed tables, and other traffic-calming measures are included in this section. These elements can be considered in the development of bicycle facilities throughout the City of El Paso,

particularly along bicycle boulevards and other shared streets, where slow motor vehicle speeds are essential to creating a welcoming environment for bicycling activity.

### Neighborhood Traffic Management Program (NTMP)

The City's Neighborhood Traffic Management Program (NTMP), "addresses concerns about safety, noise, and quality of life issues related to vehicle traffic on neighborhood streets." The manual presents program elements that act as traffic-calming interventions. The NTMP toolbox is composed of a variety of devices organized according to levels and types of problems.

Design interventions tackle one or more of the following types of problems:

- Speeding
- Traffic Volume
- Vehicle Crashes
- Pedestrian Safety
- Noise

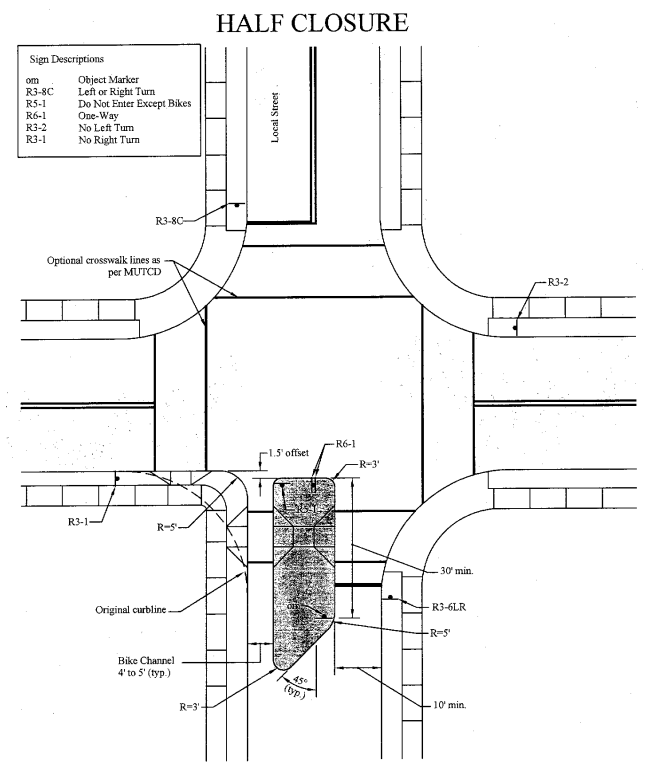

Figure A5. Traffic-calming elements like half closures limit through motor vehicle traffic, reproduced from the Design Standards for Construction.

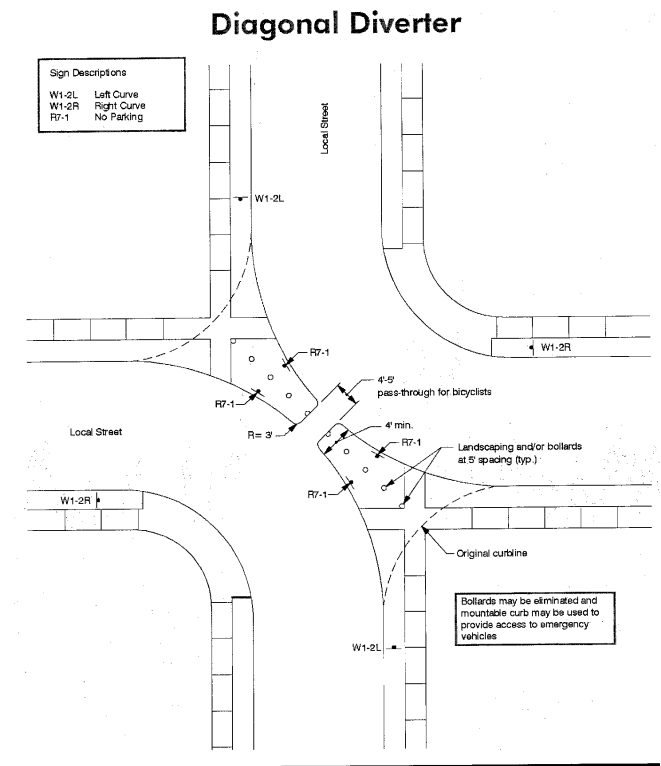

Figure A6. Diagonal diverters are another traffic-calming elements, reproduced from the Design Standards for Construction.



## El Paso Comprehensive Plan (1999)

The 1999 version of the El Paso Comprehensive Plan predates the 2012 planning effort. Each of the plan's twelve chapters presents goals, policies, and actions that help identify and eventually implement community priorities. The plan includes a chapter devoted to implementation, which aims to enact the vision that the plan sets forth.

The following list outlines the plan's major chapters that include planning targets and recommendations:

- Environment
- Transportation
- Economic and International Development Department
- Community Facilities
- Land Use & City Form
- Land Use Concepts
- Urban Design
- Implementation

## Plan El Paso (Comprehensive Plan) (2012)

*Plan El Paso*, the City of El Paso's current Comprehensive Plan, was adopted in 2012 to create a long-range vision for the future of El Paso, layout the framework for regulations and policies that will guide physical and Economic and International Development Department in the City, and establish priorities for public action and complementary private decisions. The scope of this comprehensive plan is broad and inclusive, with goals and policies for land use patterns, transportation systems, public facilities, housing, Economic and International Development Department, health sustainability, and other key considerations. Each chapter of the plan focuses on a specific issue or topic, beginning with an assessment of current conditions, followed by community concerns, strategies to address those concerns, and goals and policies to guide public and private development. Many of these chapters include or reference bicycle infrastructure and transportation, as discussed below.

### Transportation

The Plan's overall goal for transportation is ambitious,

far-reaching, and powerful: The City of El Paso wishes to become the least car-dependent city in the Southwest through meaningful travel options and land use patterns that support walkability, livability, and sustainability. Over time, El Paso will join the ranks of the most walkable and transit-rich metropolitan areas in the country. Bicycle transportation plays an important role in this shift away from auto-dependence.

### Existing Conditions

El Paso's network of bicycle facilities totals over 90 miles; however, more than half are mountain bike trails. Other facility types include signed bike routes, bike lanes, and off-street shared-use paths. The Plan notes the lack of connectivity in the existing bicycle network and the location of the majority of existing bike lanes on "high-speed arterial thoroughfares that intimidate even the most experienced urban bicyclist." The Plan suggests a direction to safe, comfortable facilities like the Pat O'Rourke Bike Trail as potential opportunities to connect El Paso neighborhoods.

The current land use and transportation system exhibits a variety of development patterns characteristic of the City's eras of growth, often mirroring national patterns of development. While Downtown and surrounding historic neighborhoods established prior to World War II are characterized by a traditional gridded network of streets and a mixture of land uses that support walking and bicycling, many post-World War II developments and roadway projects prioritize vehicular travel at the expense of non-motorized users. These more recent developments, often described as suburban in nature, funnel all traffic, including bicycle traffic, onto arterial and collector roadways, reducing local connectivity and directing bicycle traffic to busy, high-speed roadways that often lack dedicated facilities.

Sun Metro, the regional transit provider, operates 55 fixed bus routes throughout El Paso, and an additional route into Sunland Park, New Mexico. Eight major transfer centers link many of these routes together. In addition, Sun Metro has planned rapid transit systems (RTS), known as BRIO, and streetcars for multiple corridors throughout the city, increasing access to public

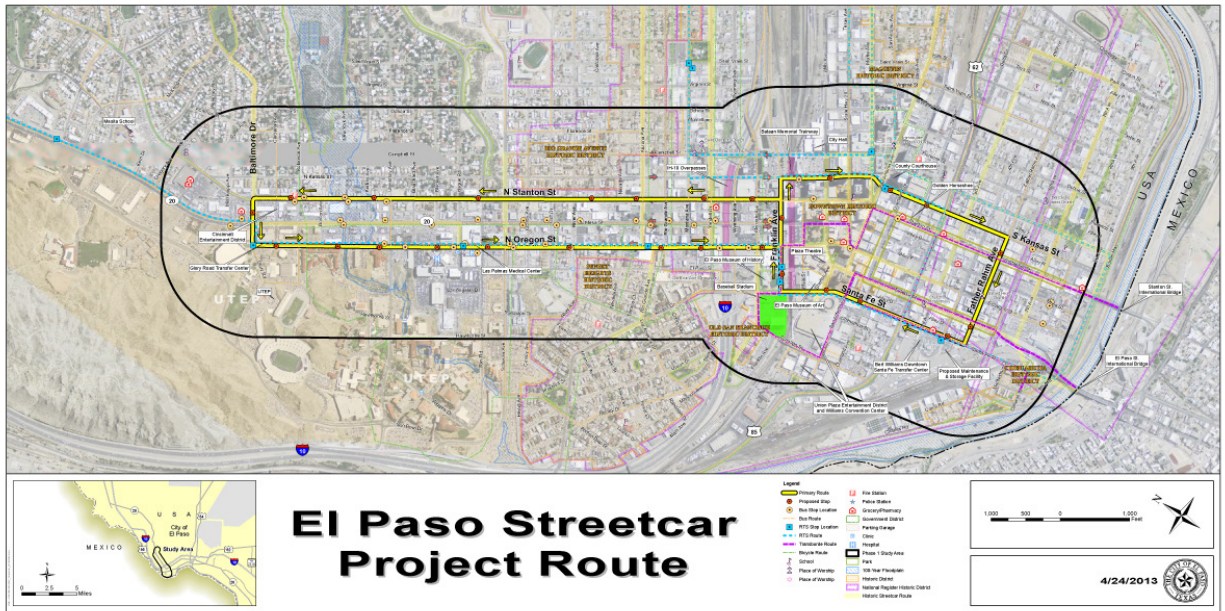

Figure A7. The proposed streetcar loop will increase transportation choices between Downtown El Paso and UTEP (reproduced from Plan El Paso).

transportation and multimodal trips. At the time the Plan was adopted, four RTS lines radiating from Downtown were in various stages of planning and development. These RTS corridors were Mesa Street along the west side, Dyer Street along the northeast, Montana Avenue along the eastside, and Alameda Avenue along the Mission Valley. These rapid transit corridors are intended to function as catalysts for transit-oriented Economic and International Development Department in which dense nodes of mixed-use activity can support walking, bicycling, and transit use. The streetcar loop, in early

planning stages at the time the Plan was adopted and currently under construction, will connect Downtown El Paso to UTEP.

### Community Concerns

Through the planning process, El Paso residents expressed their desire for significant improvements and changes to the transportation system. Seven of the nine concerns integrate or support bicycling:

- Expand transportation choices and options
- Invest in transit
- Expand safe walking and bicycling environments
- Create safe and complete streets
- Revitalize major corridors, especially Alameda
- Address congestion and traffic flow
- Make reinvestment and smart growth the priority
- Invest in the airport area as a major gateway
- Recognize El Paso's auto orientation

### Strategies for Addressing Community Concerns

In response to these community concerns, the City identified potential strategies to create a better, more responsive transportation system. Many of these strategies can have a positive impact on bicycle mobility in El Paso, including:

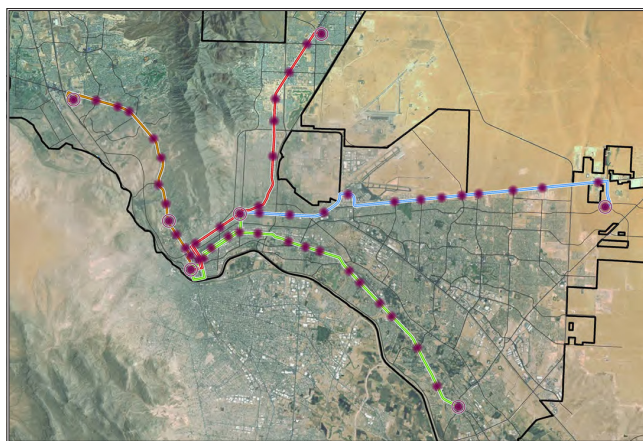

Figure A8. Plan El Paso calls for a RTS that connects all four major areas of the city (reproduced from Plan El Paso).



- Better land use as a transportation strategy
- Augment the functional classification system to acknowledge land use context
- Design walkable urban streets
- Develop multi-way boulevards on streets like Zaragoza Road
- Upgrade thoroughfare cross-sections in the 2025 Proposed Thoroughfare System, also known as the Major Thoroughfare Plan (MTP)
- Develop a regional, multi-agency transportation master plan
- Plan for bicycling
- Expand the bicycle network
- Integrate bicycling and transit
- Create a 6 Es approach to bicycling
- Increase bicycle parking supply

The Plan uses a series of illustrations to depict how gradual change to the right-of-way can increase transportation choices and create a complete street that accommodates users of all ages and abilities.

### Goals and Policies

The transportation goals and policies in *Plan El Paso* provide a framework for modifying the transportation system to meet the needs and desires of El Pasoans. The breadth and depth of these goals and policies demonstrates the City's understanding of and value for a multimodal transportation network as a transformative tool to address a variety of community needs. Recommended policies include hiring a bicycle/pedestrian coordinator, updating street design guidelines, prioritizing safety for all users over peak hour motor vehicle traffic flow, and creating maintenance programs that include regular sweeping of bicycle lanes. Nine goals and forty-two policies relate directly to bicycle transportation and are listed in the multi-page table at the end of this plan.



Existing conditions on East Yandell include a one-way traffic pattern and parking on both sides. The street is over-designed for current traffic volumes.

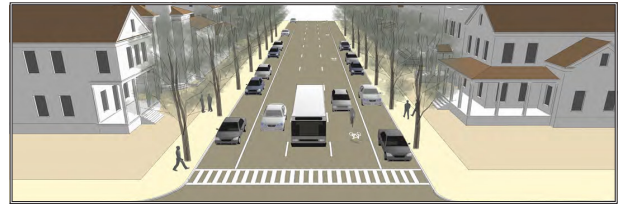

Step 1: A low cost and immediate improvement for the corridor would be the addition of Shared Use Lane Markings or "Sharrows" to indicate that this is a preferred bicycle route.



Step 2: Another intervention in the design of East Yandell envisions the installation of a buffered bike lane that would be achieved by eliminating one travel lane.

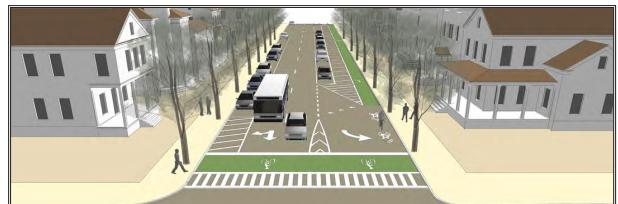

Step 3: The addition of a parking protected cycle track and bicycle box would attract a greater number of cyclists and would be appropriate on major routes.



Step 4: A future East Yandell that envisions a cycle track, covered transit stop, and bicycle box.

**Figure A9. Example of gradual change of right-of-way to accommodate multiple types of users and modes.**

## Horizon 2040 Metropolitan Transportation Plan (2014)

Adopted by the EPMPPO in 2014, the Horizon 2040 Metropolitan Transportation Plan (MTP) establishes a framework for regional transportation decisions for roadway development, freight movement, non-motorized transportation, and air quality requirements and performance. Long-range transportation plans are required for

all metropolitan planning organizations for urban areas with populations of greater than 50,000 and must meet specific criteria in terms of both process and product. The long-range transportation plan is updated every five years to incorporate new demographic and transportation data, and reflect changes in transportation system usage and public sentiment.

The MTP incorporates the goals and objectives of the 2013 Congestion Management Process (CMP), which provides a comprehensive approach to improving air quality throughout the region. One of the CMP's stated objectives for improving air quality is to increase and improve bicycling options and facilities. Performance measures associated with this objective are the length of bike lanes per corridor mile, the number of buses with bike racks, and the number of transit facilities with bike parking facilities.

The MTP encompasses more than 260 projects that aim to offer El Pasoans safe, convenient, and reliable transportation opportunities. Bicycle-specific projects account for just \$25.9M of the \$9.35B in project costs through the 2040 plan horizon, or roughly 0.2 percent of all project expenditures. More than \$2.9M is programmed in the 2013-2016 Transportation Improvement Program for bicycle infrastructure and supporting education, outreach, and plan development. While this sum represents just a fraction of the total project costs, these bicycle-specific projects can still have a significant impact on the transportation network in El Paso. Specific projects include the development of standard, buffered, and protected bike lanes throughout El Paso, the development of a bicycle plan, education and outreach efforts, staff training and professional development, implementation of phase one of a bike share system with eight stations and eighty bikes, University Centennial Trail, and numerous corridor-specific improvements for bicycle and pedestrian activity.

### 2015-2018 Horizon Transportation Improvement Program (2014)

Every two years, the EPMPPO releases a federally-required transportation improvement program (TIP), which

lists all projects that have been approved for federal funding. These projects are consistent with the Horizon 2040 Metropolitan Transportation Plan and have been approved by the EPMPPO's Transportation Policy Board, which consists of representatives of local agencies within the EPMPPO's jurisdiction. The process through which the TIP is approved is built on public participation and regional collaboration. As the document states, "The inclusion of a project in the TIP reflects a consensus of priority needs among citizens living in the EPMPPO study area, locally-elected officials, local transportation agency representatives, transit providers, and representatives of TxDOT and NMDOT. The TIP is, in effect, a listing of transportation priorities, estimated costs and recommended implementation dates."

Table A1 identifies all projects in the TIP that are bicycle-specific or have a significant bicycle component. Relevant project information, such as general description, estimated cost, and project limits are also included.

### City of El Paso Strategic Plan (2015)

The City of El Paso City Council approved and adopted the Strategic Plan on December 16, 2015. The Strategic Plan directs staff activities and initiatives to produce clearly defined results. The Strategic Plan seeks to accomplish eight goals:

- Create an environment conducive to strong, sustainable Economic and International Development Department
- Set the standard for a safe and secure city
- Promote the visual image of El Paso
- Enhance El Paso's quality of life through recreational, cultural, and educational environments
- Promote transparent and consistent communication among all members of the community
- Set the standard for sound governance and fiscal management
- Enhance and sustain El Paso's infrastructure network
- Nurture and promote a healthy, sustainable community



Table A1. 2015-2018 Bicycle-Related TIP Projects (as of May 2, 2014)

Project	Description	Phase	Project Limits	Project Cost	Sponsor
Bicycle Plan and Program 2014	Creation of a bicycle plan, education and outreach, internal staff training and education, and program implementation throughout the construction of bicycle facilities and infrastructure	Construction	Citywide	\$313,103	City of El Paso
River Bend Dr Multimodal Improvements	Implementing multimodal street improvements (pedestrians, bicycles and vehicles)	Construction, Engineering	West Sunset Rd to Frontera Rd	\$1,000,000	City of El Paso
Old Hueco Tanks Rd	Build 4 lanes divided (including bike lanes)	Construction	I-10 Gateway East / Eastlake Rd to FM 76 North Loop Dr	\$12,000,000	Socorro
Regional Bike Improvements	Regional Bike Improvements on state-owned roads	Construction, Engineering	Regional	\$602,600	TxDOT

### City of El Paso Great Streets and Corridor Plan (2016)

The Great Streets and Corridor Plan (GSCP) is a multi-faceted Complete Streets effort to increase transportation system efficiencies and support a diversity of travel modes for people of all ages and abilities. The GSCP builds on *Plan El Paso's* goal of transforming El Paso into “the least car-dependent city in the Southwest through meaningful travel options.” The GSCP includes an analysis and recommendations for the functional classification system, as well as updated design guidelines for various roadway types, from major arterials to local neighborhood streets.

### Vision, Goals, and Objectives

The GSCP's vision supports a Complete Streets approach that builds on the inclusive, multimodal values of the *Plan El Paso Comprehensive Plan* and establishes direction for the City's capital and operational investments: The City of El Paso shall plan, design, operate, and maintain a comprehensive, integrated transportation system for all ages and abilities, and all modes. This fundamental policy shift moves away from a one-dimensional approach focused on vehicular movement to a multi-dimensional approach that stresses context-sensitive design, diverse travel choices, smart growth, and public investment as a catalyst for private development.

The following eight goals provide a framework for roadway design and project development to achieve the goal of a truly multimodal transportation system:

- Provide safe, accessible, and sustainable streets.
- Provide improved intersections and/or corridors throughout the City.
- Provide multiple transportation options and improve public health.
- Provide new and modified thoroughfares that are designed to match the existing or proposed character of land along their paths.
- Provide well-connected network of streets that support driving, walking, bicycling, and public transit through design standards.
- Use the best and latest design standards, as described in the National Association of City Transportation Officials (NACTO) Urban Street Design Guide.
- Provide a balance for all user needs, while being flexible for the appropriate context.
- Improve thoroughfares over time as opportunities are found to increase transit service and improve connectivity, walkability, economic benefits, and green infrastructure to the surrounding areas.

### Thoroughfare Plan

The GSCP acknowledges and rectifies a number of inefficiencies in the current thoroughfare plan and functional classification of roadways by examining two particular focus areas in the City: Downtown and the eastern extra-territorial jurisdiction (ETJ). Current spacing of arterial roadways in both focus areas is too dense, a pattern that

is seen throughout the City in general. The Thoroughfare Plan recommends greater spacing between arterials across the City and into extra-territorial jurisdictions, consistent with the 1 to 5 miles for major arterials and 0.1 to 3 miles for minor arterials, as recommended in the American Association of State Highway and Transportation Officials (AASHTO) Policy on Geometric Design of Highways and Streets. This is done through the removal or downgrade of some existing major arterials, as well as the reconfiguration of some planned arterials in the ETJ.

### Guidelines and Implementation Plan

Created as an attachment to the GSCP, the Great Streets Guidelines & Implementation Plan provides an overview of design elements, cross sections for various street types, and implementation guidance to assist the City of El Paso and its regional partners in transforming existing rights-of-way and constructing new roadways to meet the City’s vision of a transportation system that supports safe and enjoyable travel for people of all ages and abilities, and all modes. Building on design guidelines from NACTO’s Urban Streets Design Guide and other best practices from cities across the country, proposed cross sections incorporate wider sidewalks and pedestrian zones, increased landscaping and median elements, and low-stress bicycle facilities like wide bike lanes, buffered and protected bike lanes, and shared use paths. Implementation of the GSCP is supported with a matrix designed to evaluate all roadway projects in the Capital Improvement Plan in order to determine the needed improvements to create a Great Street.

Table A2. Plan El Paso (2012) Bicycle-Related Transportation Goals and Policies

Goal	Policy
<p>Goal 4.1: New and modified thoroughfares will match the existing or proposed character of land along their paths as well as serving their essential functions in the regional road network.</p>	<p>Policy 4.1.2: Compact Urban areas include the following land as identified on the Future Land Use Map:</p> <ul style="list-style-type: none"> <li>• Existing walkable neighborhoods, identified as land in the G-1 “Downtown” and G-2 “Traditional Neighborhood” sectors.</li> <li>• Planned walkable communities, identified as land in the O-7 “Urban Expansion” sector.</li> <li>• Future redeveloped and infill neighborhoods, identified with these overlays: “Local Transfer Centers,” “RTS Stops,” and “Future Compact Neighborhoods.”</li> </ul>

Table 2A. Plan El Paso (2012) Bicycle-Related Transportation Goals and Policies, continued

Goal	Policy
<p>Goal 4.1 continued</p>	<p>Policy 4.1.2: Compact Urban areas include the following land as identified on the Future Land Use Map:</p> <ul style="list-style-type: none"> <li>• Existing walkable neighborhoods, identified as land in the G-1 “Downtown” and G-2 “Traditional Neighborhood” sectors.</li> <li>• Planned walkable communities, identified as land in the O-7 “Urban Expansion” sector.</li> <li>• Future redeveloped and infill neighborhoods, identified with these overlays: “Local Transfer Centers,” “RTS Stops,” and “Future Compact Neighborhoods.”</li> </ul>
	<p>Policy 4.1.5: In Compact Urban areas, multimodal transportation design will become the norm to enhance neighborhood character, safety, and walkability. Character and function will be more important than capacity, and the street network will be sized to yield smaller blocks with greater “people moving” capacity.</p>
	<p>Policy 4.1.7: The City of El Paso maintains a design manual in Title 19 of its subdivision regulations entitled Design Standards for Construction. That manual should be updated to add appropriate cross-sections for thoroughfares in Compact Urban areas. In the interim, thoroughfares in Compact Urban areas should be designed using the following standards:</p> <ul style="list-style-type: none"> <li>• Design Parameters for Walkable Urban Thoroughfares, which are contained in the ITE Recommended Practice, Designing Walkable Urban Thoroughfares: A Context Sensitive Approach, using design parameters for the C-3, C-4, C-5, and C-6 context zones.</li> <li>• Thoroughfare Assemblies, which are in the SmartCode, Title 21 of the City’s land development regulations.</li> </ul>
<p>Goal 4.2: El Paso’s thoroughfares will form a well-connected network of complete streets that support driving, walking, bicycling, and public transit.</p>	<p>Policy 4.2.1: Street design standards should provide safe, accessible, and meaningful travel choices—driving, walking, bicycling, and public transit. Separate policies for bicycling and public transit are provided under Goals 4.8, 4.9, and 4.11.</p>
	<p>Policy 4.2.2: The City will strengthen its standards for connectivity of local streets by amending Title 19 as described under Goal 2.3 of the Urban Design Element.</p>
	<p>Policy 4.2.3: Where optimal street connectivity cannot be or has not been provided, non-motorized connections should be added to reduce walking and bicycling trip lengths.</p>
	<p>Policy 4.2.4: In Compact Urban areas, walkability will be prioritized with wide sidewalks, shade, alleys, and streetfacing access to adjacent land uses.</p> <ul style="list-style-type: none"> <li>• Widen sidewalks where appropriate and feasible.</li> <li>• Plant regularly spaced drought-tolerant trees along streets.</li> <li>• Provide streetlights that improve safety for drivers, bicyclists, and pedestrians while maintaining a dark sky.</li> <li>• Curb and gutter construction should be used to prevent flooding on streets and sidewalks where appropriate.</li> <li>• Curb radii should be small to discourage drivers from turning corners quickly.</li> <li>• Alleys should be included in most blocks so that buildings may be serviced from the rear, driveways and curb cuts can be minimized, and parking can be consolidated at mid-block locations.</li> <li>• Provide safe and convenient crosswalks at intersections, and at mid-block crossings where feasible and needed.</li> </ul>

Table 2A. Plan El Paso (2012) Bicycle-Related Transportation Goals and Policies, continued

Goal	Policy
Goal 4.2, continued	Policy 4.2.9: The City will make safety a priority for all travel modes and users, especially for the most vulnerable users (pedestrians, children, and those who are physically impaired).
Goal 4.3: The City of El Paso will improve its thoroughfares over time as opportunities are found to increase transit service and improve connectivity, walkability, bikability, and economic benefits to surrounding areas.	Policy 4.3.1: The City will incrementally improve its network of wide arterial roads into a lattice that connects humane, safe, and functional neighborhood centers by managing vehicular speeds, constructing pedestrian facilities, improving public transit, and encouraging a vibrant mix of land uses.
Goal 4.4: Transform the Major Thoroughfare Plan (MTP) into a Sustainable Mobility Plan (SMP) that integrates all major travel modes and carries out the goals and policies of Plan El Paso.	<p>Policy 4.4.3: The SMP will include the following refinements to the MTP:</p> <ul style="list-style-type: none"> <li>• Broaden and refine the MTP to include a multimodal transportation network to supplement the road network now shown.</li> <li>• Review and update the current MTP road network to reflect the growth forecasts and other policies in Plan El Paso.</li> <li>• Refine the MTP's thoroughfare classification system to reflect the concepts in this Transportation Element while maintaining compatibility with the MPO's federally mandated system.</li> <li>• Update thoroughfare cross-sections to reflect the concepts in this Transportation Element.</li> <li>• Use today's best practices for network design principles as described under Goal 4.4.</li> </ul>
Goal 4.5: El Paso's network of major thoroughfares will become the "Great Streets" of tomorrow. They will be integral parts of the communities that surround them, allowing easy movement and providing physical space for social, civic, and commercial activities.	Policy 4.5.1: El Paso's future transportation network will shape the City and its inhabitants. The network must meld all viable modes of transportation and carry out the goals of Plan El Paso.
	Policy 4.5.2: Capacity and redundancy should be created by a densely interconnected network rather than by achieving high capacities on individual arterial streets.
	<p>Policy 4.5.3: More narrow thoroughfares are better than fewer wide ones. When major thoroughfares are spaced too far apart, these consequences are unavoidable:</p> <ul style="list-style-type: none"> <li>• The remaining major thoroughfares must be too wide, eroding their placemaking capacity and making them inhospitable to pedestrians and bicyclists.</li> <li>• Motorized traffic may encroach on neighborhood streets designed for lighter traffic volumes.</li> <li>• Transit routes along the remaining thoroughfares become inefficient to provide and unpleasant to use.</li> <li>• Intersections with other wide roads will inevitably restrict the theoretical capacity of wide roads.</li> <li>• This restriction cannot be solved with grade-separated intersections because they are too expensive to construct and maintain and too damaging to surrounding land uses.</li> </ul>



Table 2A. Plan El Paso (2012) Bicycle-Related Transportation Goals and Policies, continued

Goal	Policy
Goal 4.5 continued	Policy 4.5.4: Economically vital cities require multiple transportation modes and cannot hope to maintain free flowing traffic during all peak periods.
	Policy 4.5.5: The character of each thoroughfare should be based on the physical context the thoroughfare is passing through in addition to its role in the larger network.
	Policy 4.5.6: Limited-access freeways disrupt the healthy functioning of cities and should be the thoroughfare type of last resort when planning an urban network.
	Policy 4.5.8: The regional transportation network must respect the human and natural environment and minimize or eliminate negative impacts such as bisecting or isolating communities, inducing suburban sprawl, or interfering with arroyos and other natural systems.
Goal 4.7: Improve the region's air quality through more sustainable and energy-efficient transportation and land use practices.	Policy 4.7.1: Encourage compact land uses and urban design patterns that increase travel choices, reduce reliance on single-occupant vehicle travel, and reduce the overall number of vehicle-miles traveled.
Goal 4.8: Vigorously expand bicycle facilities throughout El Paso County to create a full network of connected, safe, and attractive bikeways and supporting facilities for both transportation and recreation.	Policy 4.8.1: Update the 1997 Regional Bikeways Plan using the Bicycle Atlas in this Element as a guide to network connectivity.
	Policy 4.8.2: Continue developing and maintaining a system of bicycle lanes, bicycle routes, and multi-use pathways in accordance with the City's most recent bicycle master plan and the Bicycle Facilities Design Manual.
	Policy 4.8.3: Coordinate planning, design, and implementation of bicycle improvements within the City, surrounding municipalities, El Paso County, and surrounding areas in order to effectively promote regional connectivity.
	Policy 4.8.4: Utilize the principles described in Plan El Paso to guide planning, design, and implementation of bicycle infrastructure in conjunction with other City plans and projects.
	Policy 4.8.5: Investigate the possibility of a local bicycle share program in the City that places bicycles for rent at automated stations at key areas beginning with the Downtown and university areas.
	Policy 4.8.6: Routinely include bicycle facilities in the City's capital projects, and coordinate with El Paso County, the other municipalities, and the MPO to ensure bicycle infrastructure is included in their capital improvement plans.
	Policy 4.8.7: Fund a bicycle and pedestrian coordinator position to be the steward of the bicycle master plan and all of its individual components.
	Policy 4.8.8: Use best practices in physical design (i.e., bikeway width, type, signing, and advanced bicycle facility types) to create safer bikeways. Train select City staff to design bikeways.

Table 2A. Plan El Paso (2012) Bicycle-Related Transportation Goals and Policies, continued

Goal	Policy
Goal 4.8 continued	Policy 4.8.9: Enhance the safety and visibility of the bicycle network through the implementation of safety and wayfinding signing improvements along all current and future bikeways.
	Policy 4.8.10: Implement a regular street sweeping program, with priority given to bicycle lanes and primary bicycle routes.
	Policy 4.8.11: Increase the availability and quality of bicycle parking and support facilities (i.e., showers and lockers) through measures such as: <ul style="list-style-type: none"> <li>• Update bicycle parking requirements to include short- and long-term parking facilities and standards through a City-wide bicycle parking and facilities plan.</li> <li>• Provide an adequate amount of secure properly positioned bicycle parking at key trip attractors and generators throughout the community. Design should be in accordance with the Bicycle Facilities Design Manual.</li> <li>• Update bicycle parking requirements with refined bicycle parking ratios and graphic standards that depict bicycle parking type, placement, and location standards.</li> </ul>
Goal 4.9: Encourage increased bicycling by promoting health, recreation, transportation, tourism opportunities, and environmental benefits.	Policy 4.9.1: Develop a strategy to acquire designation as a Bicycle-Friendly Community by the League of American Bicyclists by 2015.
	Policy 4.9.2: Make El Paso a safer city for bicycle riders through measures such as:
	Work with the El Paso Police Department to address bicycle-vehicle safety measures through increased awareness of bicycle-related traffic laws and enforcement of existing and new laws.
	Provide on-going training for City of El Paso police officers regarding bicycle safety laws and issues.
	Maintain the number of bicycle patrol officers and consider expanding the force.
	Policy 4.9.3: Create and distribute print and online versions of the El Paso Bikeways Map on an annually updated basis, to include wayfinding, safety, and facility type information.
	Policy 4.9.4: Develop an El Paso bicycle programs website to store and disseminate all bicycle-related information, including bicycle traffic statistics.
	Policy 4.9.5: Identify the most common conflicts between bicycle and motor vehicle users and create strategies to educate all roadway users.
	Policy 4.9.6: Increase awareness of bicycle options and safety through trainings, public events, public service announcements, educational materials, and partnerships.
	Policy 4.9.7: Promote bicycling for commuting, running errands and other short trips and socializing through social media/web-based communication tools and traditional communication outlets to position bicycling as a viable option for people who are interested in bicycling, but concerned about safety.
Policy 4.9.8: Create and implement a partnership with the Safe Routes to School program.	

Table 2A. Plan El Paso (2012) Bicycle-Related Transportation Goals and Policies, continued

Goal	Policy
<p>Goal 4.9 continued</p>	<p>Policy 4.9.9: Continue to support, fund, and expand Scenic Sundays.</p>
	<p>Policy 4.9.10: Develop bicycle policies and programs that address geographic, racial, ethnic, economic, environmental, and public health disparities.</p>
	<p>Policy 4.9.11: Utilize small-scale incremental interventions to instigate conversation about positive change in the built environment. Tactical, temporary, repurposing of streets like El Paso’s ciclovia which converts vehicular streets to pedestrian uses, and the El Paso Transnational Trolley project art exhibit which furthered discussion concerning the reestablishing of the trolley between Ciudad Juárez and El Paso are two examples.</p>
<p>Goal 4.11: El Paso will have a safe, convenient, and economically viable public transit system that optimizes personal mobility, strengthens community character and economic vitality, and seamlessly integrates with other travel modes. The existing bus network will evolve into a multi-faceted regional transit network with frequent service on four Rapid Transit System (RTS) lines and, over time, other forms of high-capacity transit service.</p>	<p>Policy 4.11.1: All bus stops and transit stations should be safe, comfortable, and attractive. Non-motorized connections such as sidewalks and bicycle routes/trails will be the most important connections to stops and stations.</p>
	<p>Policy 4.11.2: The City should require major commercial and residential developments to provide adequate sidewalks and suitable areas for bus stops with bicycle storage.</p>

## Appendix B: Bike Network Atlas



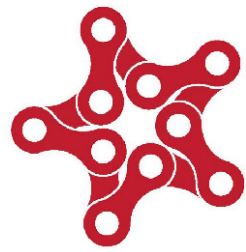

# El Paso Bike Plan Atlas

## Legend

### Existing Bicycle Facilities

- Shared Lane Markings
- Shoulder Bikeway
- Bike Lane
- Buffered Bike Lane
- Shared Use Path

### Proposed Bicycle Facilities

- Signed Shared Roadway
- Shared Lane Markings
- Bicycle Boulevard
- Shoulder Bikeway
- Bike Lane
- Buffered Bike Lane
- Protected Bike Lane / Cycle Track
- Two-Way Cycle Track
- Shared Use Path
- Further Study Needed

### Other Features\*

- SunCycle Bike Share Station (Existing)
- SunCycle Bike Share Station (Planned)
- School
- El Paso Community College Campus
- Public Housing
- International Bridge/Port of Entry
- Waterways
- Parks
- City of El Paso
- Fort Bliss

\* Not all features displayed on Atlas Index to the right.

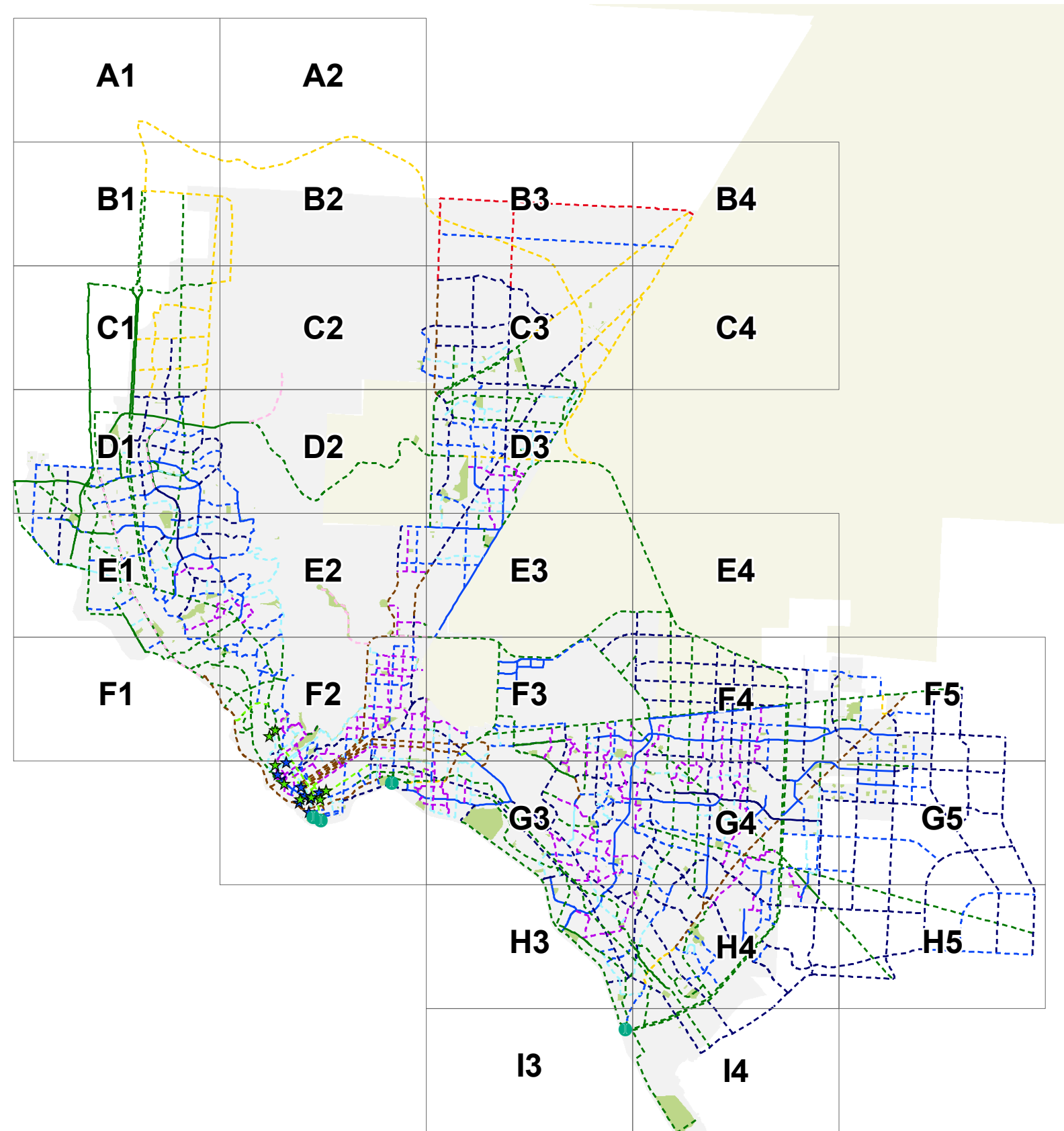

# A1

## Bicycle Facilities

### Existing

- Shared Lane Markings
- Shoulder Bikeway
- Bike Lane
- Buffered Bike Lane
- Shared Use Path

### Proposed

- Signed Shared Roadway
- Shared Lane Markings
- Bicycle Boulevard
- Shoulder Bikeway
- Bike Lane
- Buffered Bike Lane
- Protected Bike Lane / Cycle Track
- Two-Way Cycle Track
- Shared Use Path
- Further Study Needed

### SunCycle Bike Share Station

- Existing
- Planned

A1	A2			
B1	B2	B3	B4	
C1	C2	C3	C4	
D1	D2	D3		
E1	E2	E3	E4	
F1	F2	F3	F4	F5
	G2	G3	G4	G5
		H3	H4	H5
		I3	I4	

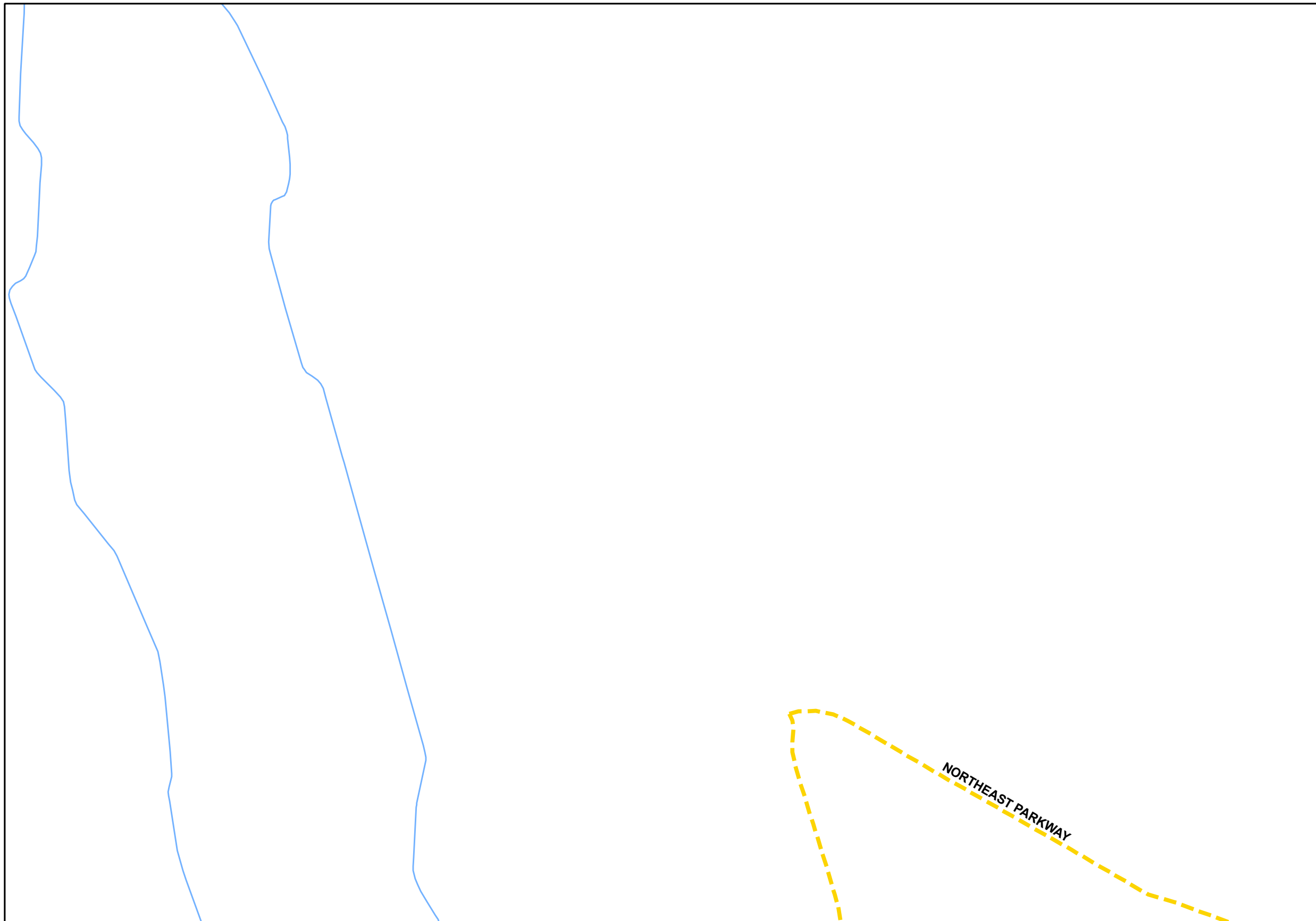
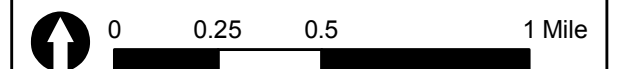

# A2

## Bicycle Facilities

### Existing

- Shared Lane Markings
- Shoulder Bikeway
- Bike Lane
- Buffered Bike Lane
- Shared Use Path

### Proposed

- Signed Shared Roadway
- Shared Lane Markings
- Bicycle Boulevard
- Shoulder Bikeway
- Bike Lane
- Buffered Bike Lane
- Protected Bike Lane / Cycle Track
- Two-Way Cycle Track
- Shared Use Path
- Further Study Needed

### SunCycle Bike Share Station

- Existing
- Planned

A1	A2			
B1	B2	B3	B4	
C1	C2	C3	C4	
D1	D2	D3		
E1	E2	E3	E4	
F1	F2	F3	F4	F5
	G2	G3	G4	G5
		H3	H4	H5
		I3	I4	

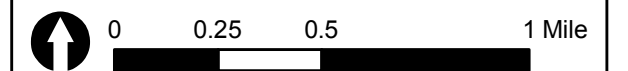
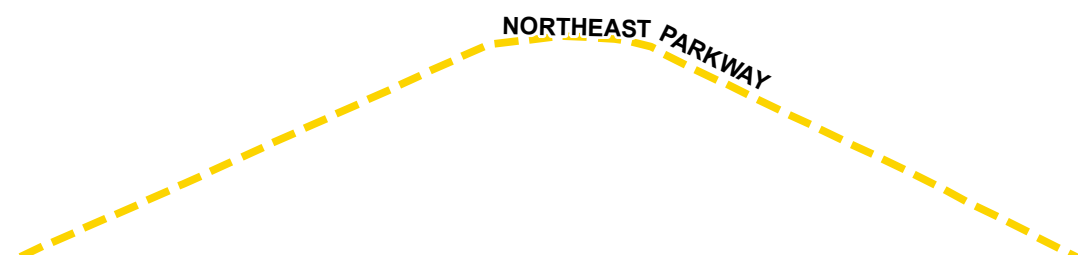

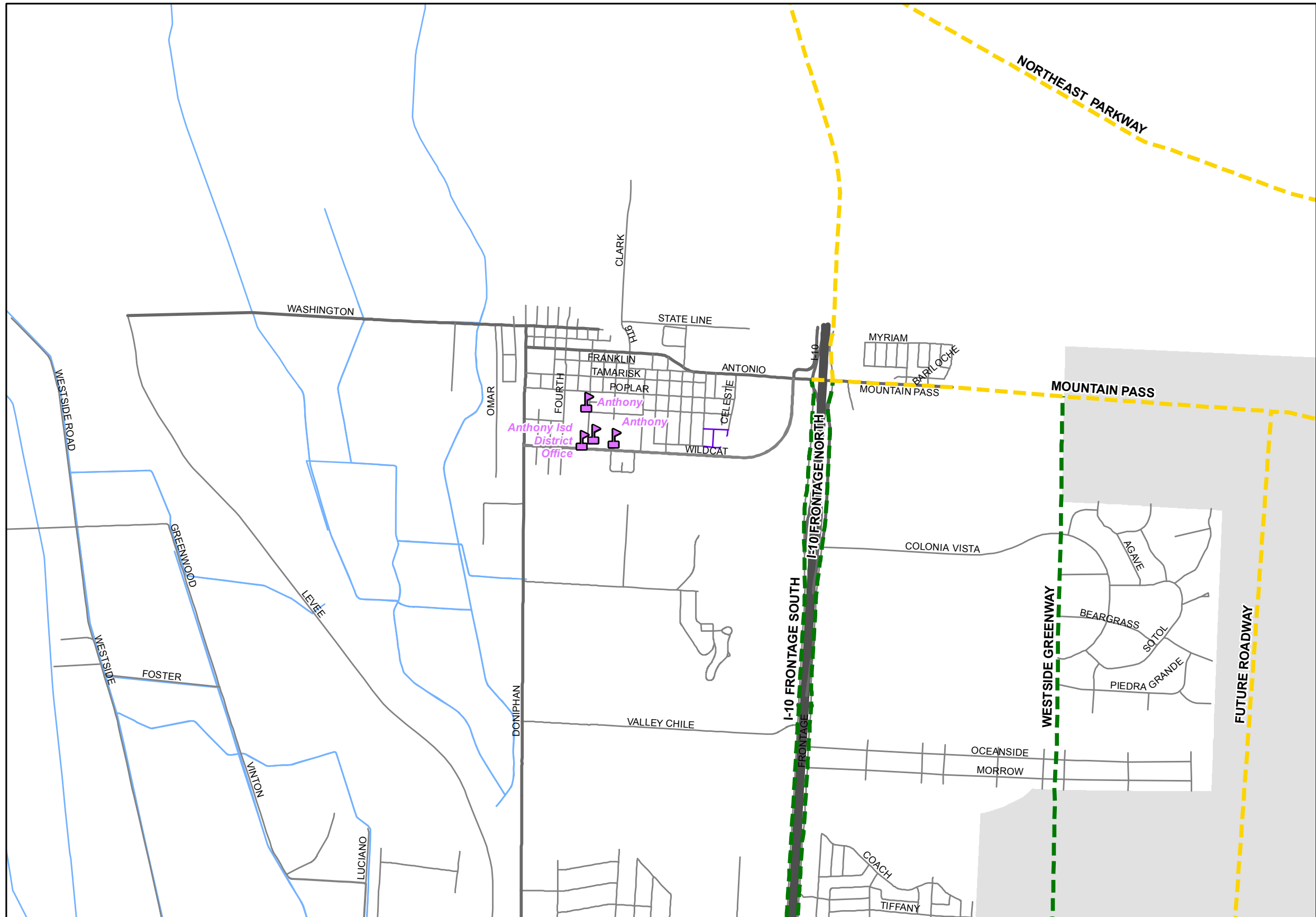

# B1

## Bicycle Facilities

- Existing**
- Shared Lane Markings
  - Shoulder Bikeway
  - Bike Lane
  - Buffered Bike Lane
  - Shared Use Path
- Proposed**
- Signed Shared Roadway
  - Shared Lane Markings
  - Bicycle Boulevard
  - Shoulder Bikeway
  - Bike Lane
  - Buffered Bike Lane
  - Protected Bike Lane / Cycle Track
  - Two-Way Cycle Track
  - Shared Use Path
  - Further Study Needed
- SunCycle Bike Share Station**
- Existing
  - Planned

A1	A2			
B1	B2	B3	B4	
C1	C2	C3	C4	
D1	D2	D3		
E1	E2	E3	E4	
F1	F2	F3	F4	F5
	G2	G3	G4	G5
		H3	H4	H5
		I3	I4	

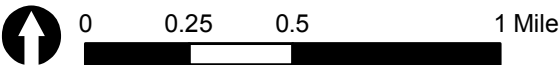



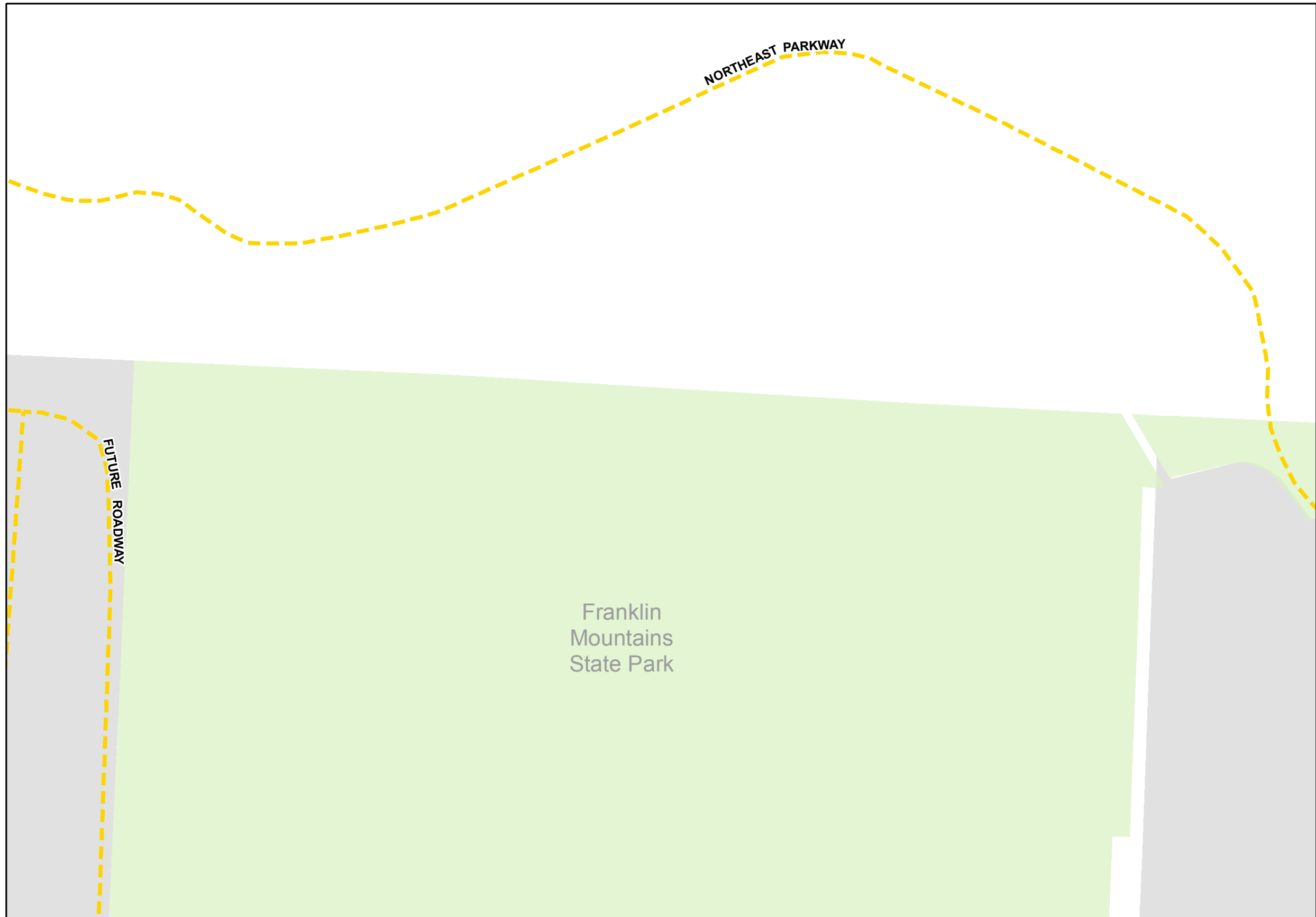

# B2

## Bicycle Facilities

- Existing**
- Shared Lane Markings
  - Shoulder Bikeway
  - Bike Lane
  - Buffered Bike Lane
  - Shared Use Path
- Proposed**
- Signed Shared Roadway
  - Shared Lane Markings
  - Bicycle Boulevard
  - Shoulder Bikeway
  - Bike Lane
  - Buffered Bike Lane
  - Protected Bike Lane / Cycle Track
  - Two-Way Cycle Track
  - Shared Use Path
  - Further Study Needed
- SunCycle Bike Share Station**
- Existing
  - Planned

A1	A2			
B1	<b>B2</b>	B3	B4	
C1	C2	C3	C4	
D1	D2	D3		
E1	E2	E3	E4	
F1	F2	F3	F4	F5
	G2	G3	G4	G5
		H3	H4	H5
		I3	I4	

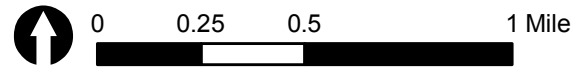

# B3

## Bicycle Facilities

- Existing**
- Shared Lane Markings
  - Shoulder Bikeway
  - Bike Lane
  - Buffered Bike Lane
  - Shared Use Path
- Proposed**
- Signed Shared Roadway
  - Shared Lane Markings
  - Bicycle Boulevard
  - Shoulder Bikeway
  - Bike Lane
  - Buffered Bike Lane
  - Protected Bike Lane / Cycle Track
  - Two-Way Cycle Track
  - Shared Use Path
  - Further Study Needed
- SunCycle Bike Share Station**
- Existing
  - Planned

A1	A2			
B1	B2	<b>B3</b>	B4	
C1	C2	C3	C4	
D1	D2	D3		
E1	E2	E3	E4	
F1	F2	F3	F4	F5
	G2	G3	G4	G5
		H3	H4	H5
		I3	I4	

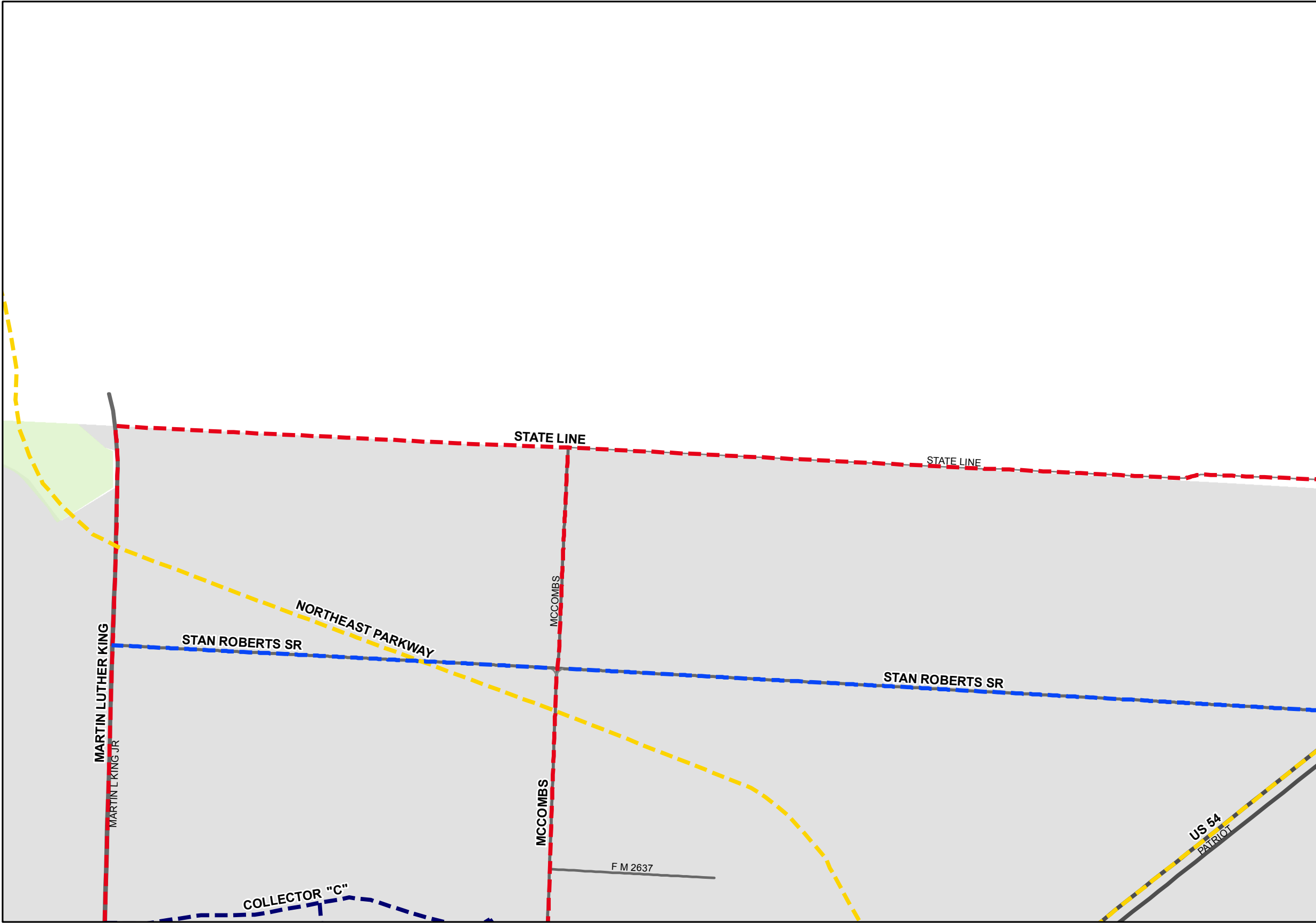
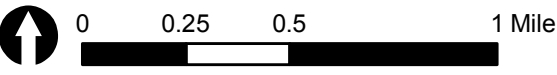

# B4

## Bicycle Facilities

- Existing**
- Shared Lane Markings
  - Shoulder Bikeway
  - Bike Lane
  - Buffered Bike Lane
  - Shared Use Path
- Proposed**
- Signed Shared Roadway
  - Shared Lane Markings
  - Bicycle Boulevard
  - Shoulder Bikeway
  - Bike Lane
  - Buffered Bike Lane
  - Protected Bike Lane / Cycle Track
  - Two-Way Cycle Track
  - Shared Use Path
  - Further Study Needed
- SunCycle Bike Share Station**
- Existing
  - Planned

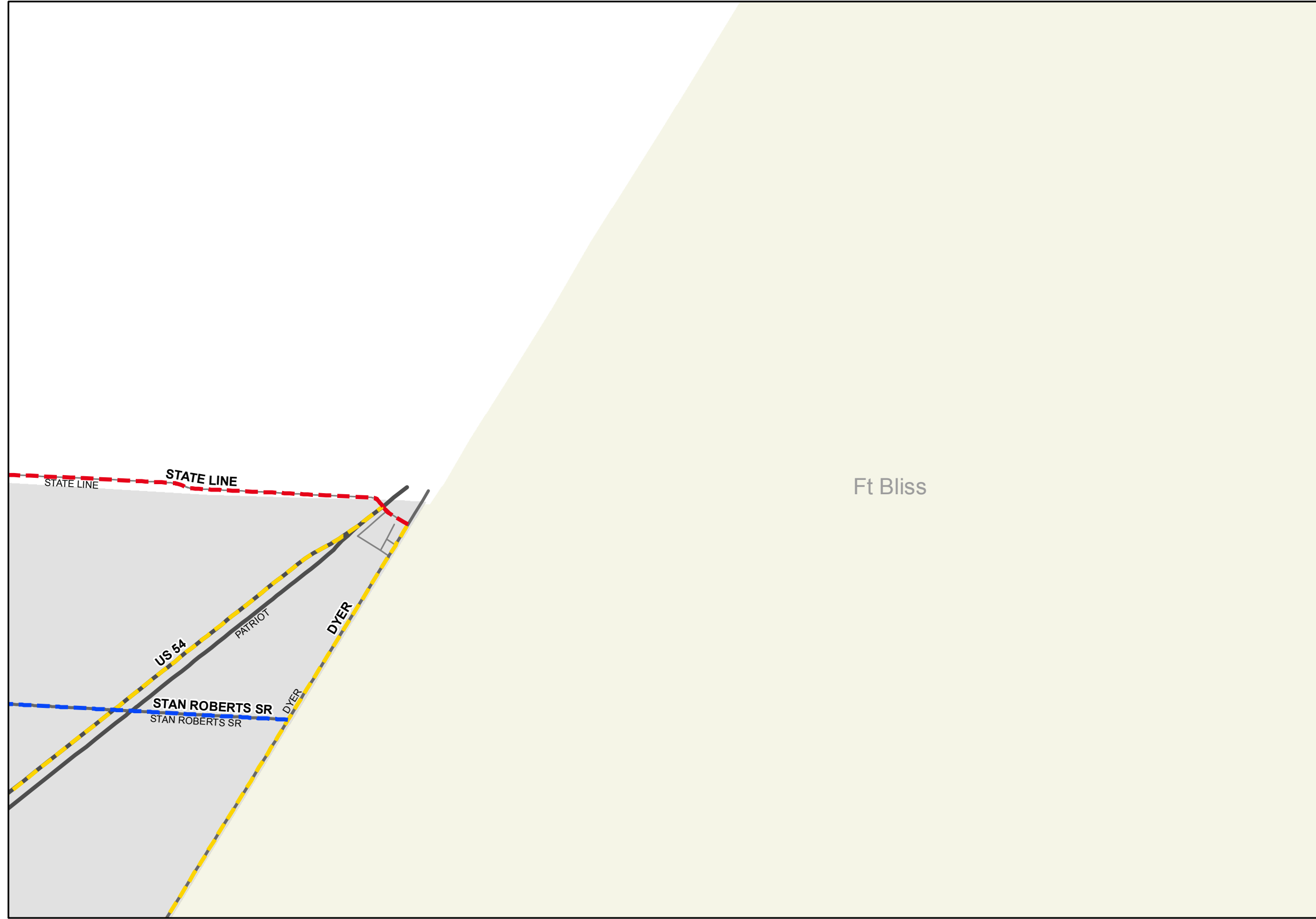

A1	A2			
B1	B2	B3	<b>B4</b>	
C1	C2	C3	C4	
D1	D2	D3		
E1	E2	E3	E4	
F1	F2	F3	F4	F5
	G2	G3	G4	G5
		H3	H4	H5
		I3	I4	

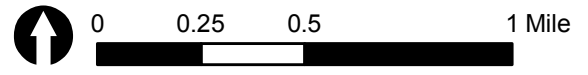

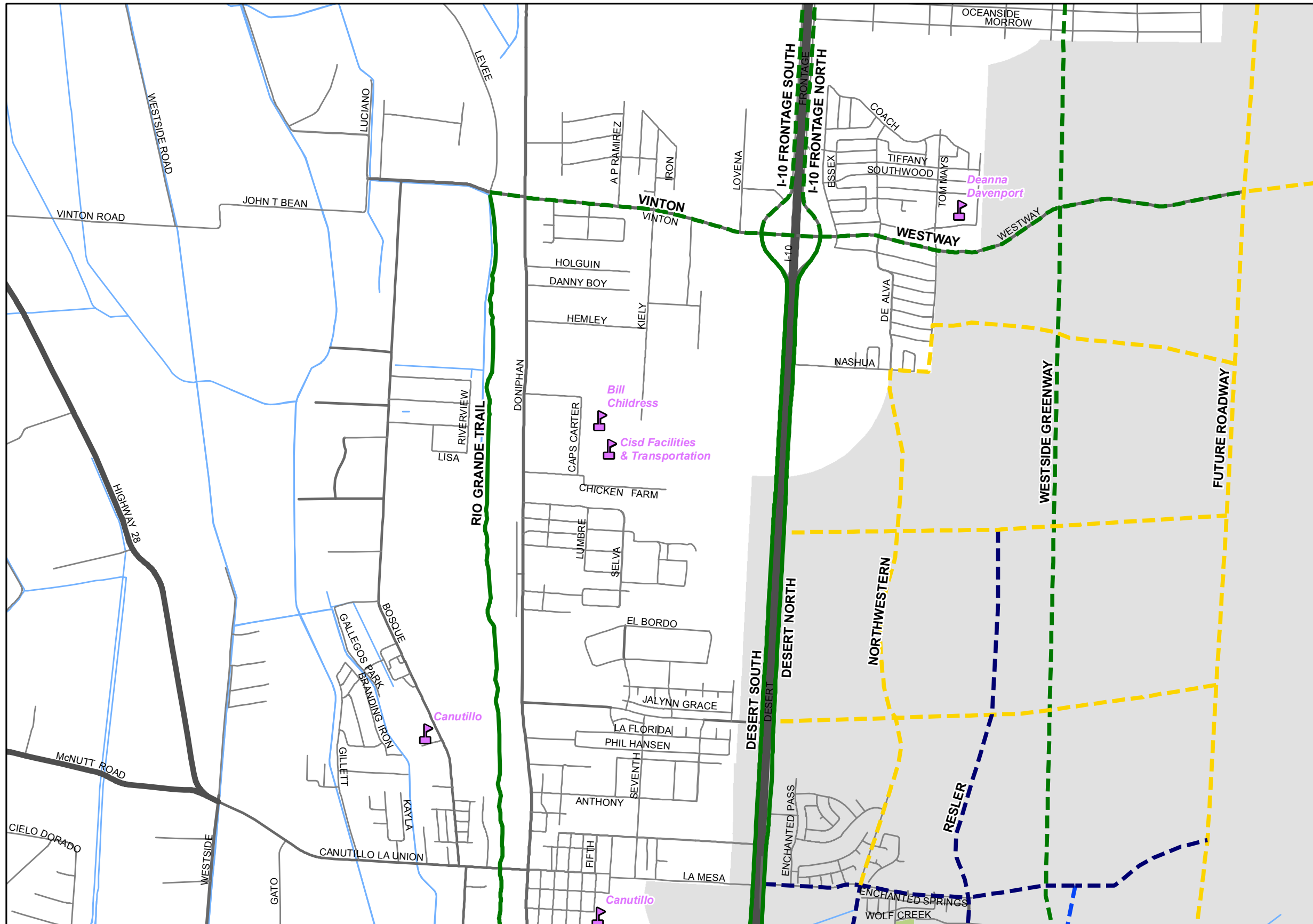

# C1

## Bicycle Facilities

### Existing

- Shared Lane Markings
- Shoulder Bikeway
- Bike Lane
- Buffered Bike Lane
- Shared Use Path

### Proposed

- Signed Shared Roadway
- Shared Lane Markings
- Bicycle Boulevard
- Shoulder Bikeway
- Bike Lane
- Buffered Bike Lane
- Protected Bike Lane / Cycle Track
- Two-Way Cycle Track
- Shared Use Path
- Further Study Needed

### SunCycle Bike Share Station

- Existing
- Planned

A1	A2			
B1	B2	B3	B4	
<b>C1</b>	C2	C3	C4	
D1	D2	D3		
E1	E2	E3	E4	
F1	F2	F3	F4	F5
	G2	G3	G4	G5
		H3	H4	H5
		I3	I4	

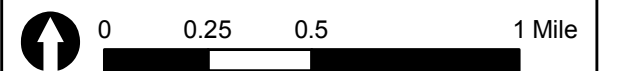



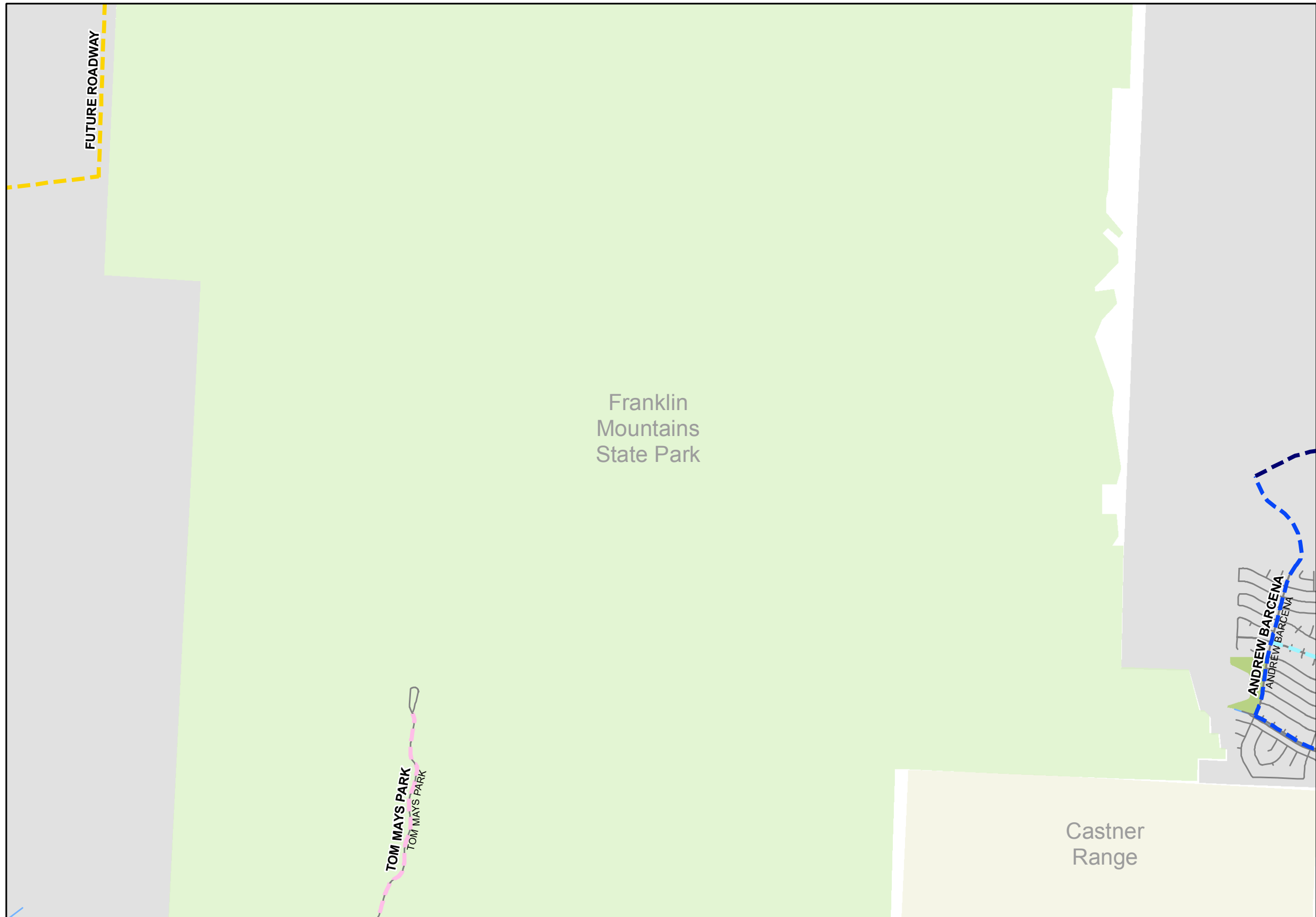

# C2

## Bicycle Facilities

- Existing**
- Shared Lane Markings
  - Shoulder Bikeway
  - Bike Lane
  - Buffered Bike Lane
  - Shared Use Path
- Proposed**
- Signed Shared Roadway
  - Shared Lane Markings
  - Bicycle Boulevard
  - Shoulder Bikeway
  - Bike Lane
  - Buffered Bike Lane
  - Protected Bike Lane / Cycle Track
  - Two-Way Cycle Track
  - Shared Use Path
  - Further Study Needed
- SunCycle Bike Share Station**
- Existing
  - Planned

A1	A2			
B1	B2	B3	B4	
C1	<b>C2</b>	C3	C4	
D1	D2	D3		
E1	E2	E3	E4	
F1	F2	F3	F4	F5
	G2	G3	G4	G5
		H3	H4	H5
		I3	I4	

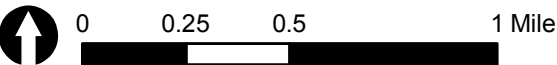

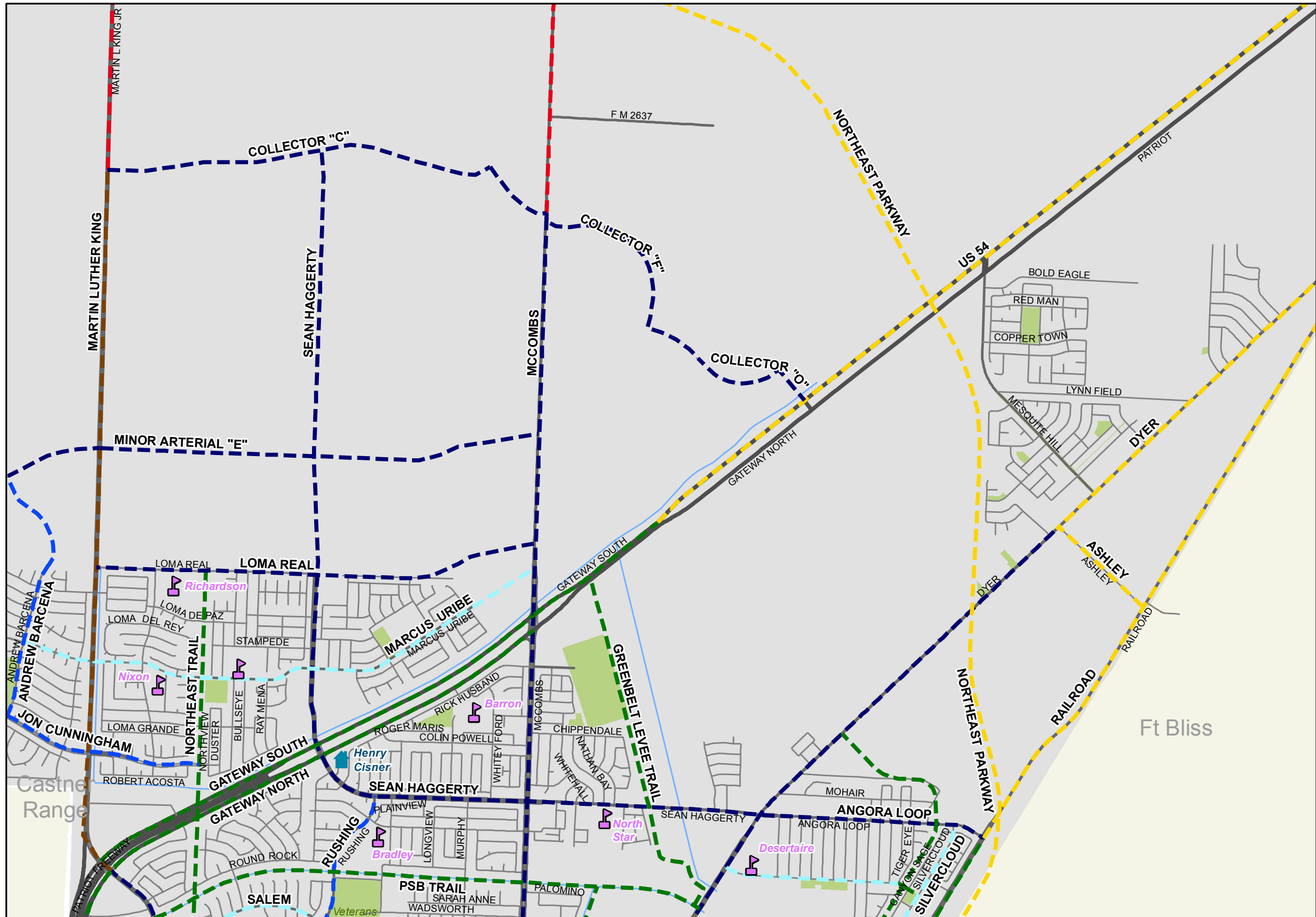

# C3

## Bicycle Facilities

- Existing**
- Shared Lane Markings
  - Shoulder Bikeway
  - Bike Lane
  - Buffered Bike Lane
  - Shared Use Path

- Proposed**
- - - Signed Shared Roadway
  - - - Shared Lane Markings
  - - - Bicycle Boulevard
  - - - Shoulder Bikeway
  - - - Bike Lane
  - - - Buffered Bike Lane
  - - - Protected Bike Lane / Cycle Track
  - - - Two-Way Cycle Track
  - - - Shared Use Path
  - - - Further Study Needed

## SunCycle Bike Share Station

- ★ Existing
- ★ Planned

A1	A2			
B1	B2	B3	B4	
C1	C2	<b>C3</b>	C4	
D1	D2	D3		
E1	E2	E3	E4	
F1	F2	F3	F4	F5
	G2	G3	G4	G5
		H3	H4	H5
		I3	I4	

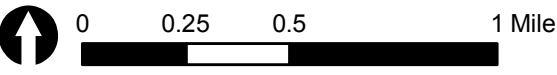

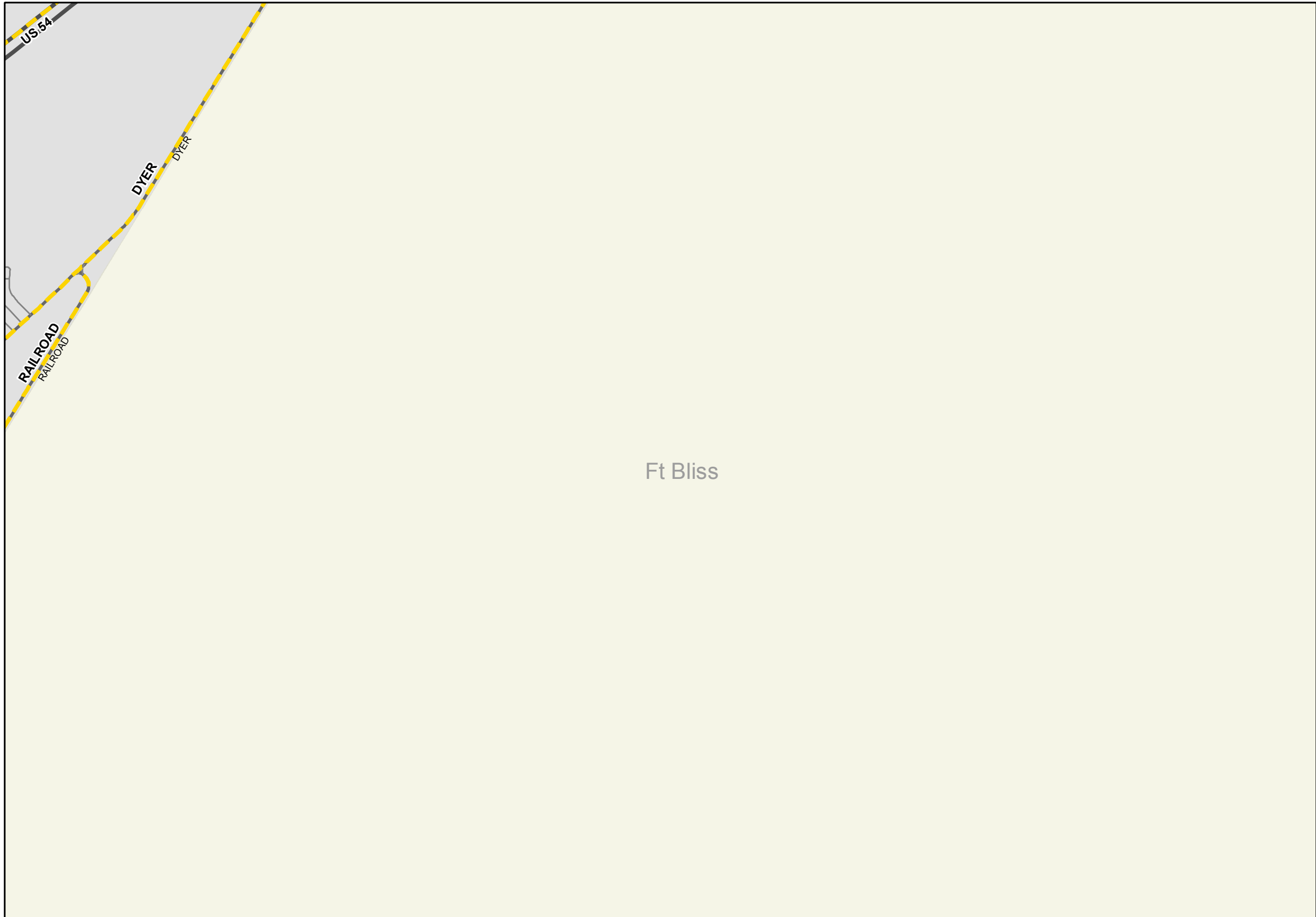

# C4

## Bicycle Facilities

- Existing**
- Shared Lane Markings
  - Shoulder Bikeway
  - Bike Lane
  - Buffered Bike Lane
  - Shared Use Path
- Proposed**
- Signed Shared Roadway
  - Shared Lane Markings
  - Bicycle Boulevard
  - Shoulder Bikeway
  - Bike Lane
  - Buffered Bike Lane
  - Protected Bike Lane / Cycle Track
  - Two-Way Cycle Track
  - Shared Use Path
  - Further Study Needed
- SunCycle Bike Share Station**
- Existing
  - Planned

A1	A2			
B1	B2	B3	B4	
C1	C2	C3	<b>C4</b>	
D1	D2	D3		
E1	E2	E3	E4	
F1	F2	F3	F4	F5
	G2	G3	G4	G5
		H3	H4	H5
		I3	I4	

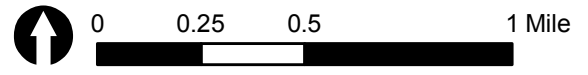

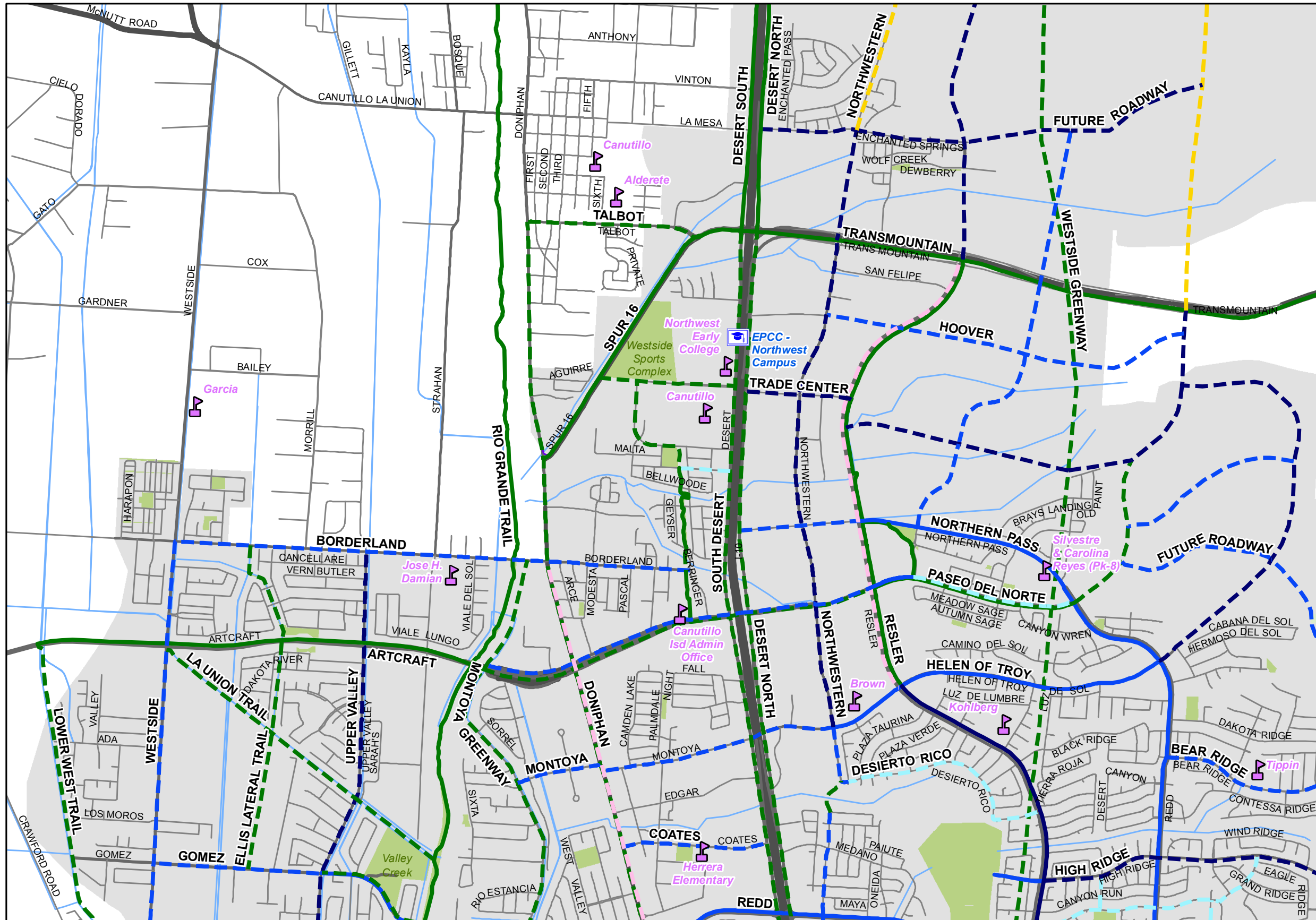

# D1

## Bicycle Facilities

### Existing

- Shared Lane Markings
- Shoulder Bikeway
- Bike Lane
- Buffered Bike Lane
- Shared Use Path

### Proposed

- Signed Shared Roadway
- Shared Lane Markings
- Bicycle Boulevard
- Shoulder Bikeway
- Bike Lane
- Buffered Bike Lane
- Protected Bike Lane / Cycle Track
- Two-Way Cycle Track
- Shared Use Path
- Further Study Needed

### SunCycle Bike Share Station

- Existing
- Planned

A1	A2			
B1	B2	B3	B4	
C1	C2	C3	C4	
<b>D1</b>	D2	D3		
E1	E2	E3	E4	
F1	F2	F3	F4	F5
	G2	G3	G4	G5
		H3	H4	H5
		I3	I4	

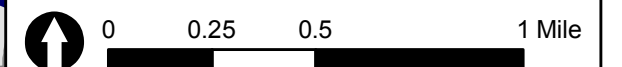



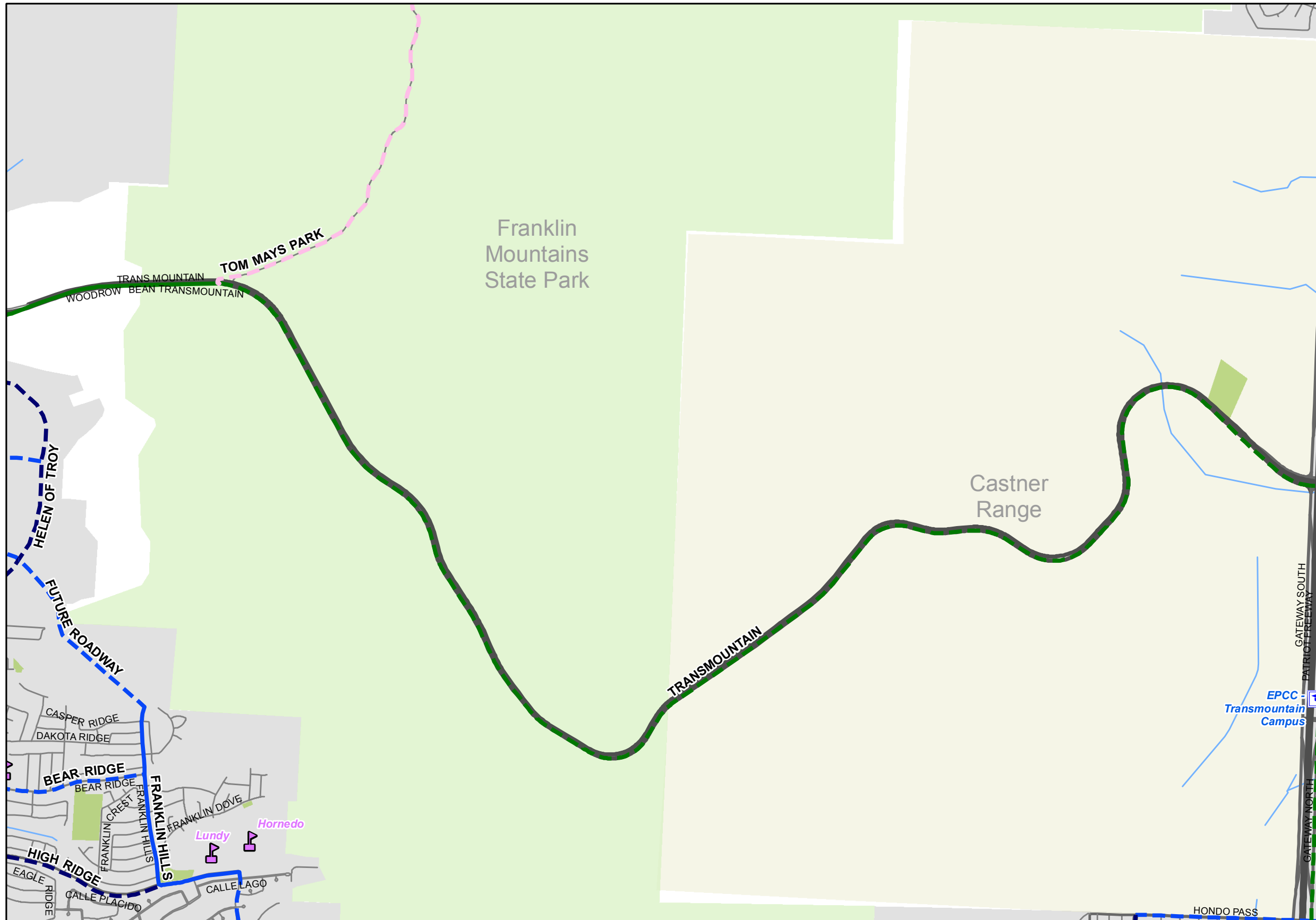

# D2

## Bicycle Facilities

### Existing

- Shared Lane Markings
- Shoulder Bikeway
- Bike Lane
- Buffered Bike Lane
- Shared Use Path

### Proposed

- Signed Shared Roadway
- Shared Lane Markings
- Bicycle Boulevard
- Shoulder Bikeway
- Bike Lane
- Buffered Bike Lane
- Protected Bike Lane / Cycle Track
- Two-Way Cycle Track
- Shared Use Path
- Further Study Needed

### SunCycle Bike Share Station

- Existing
- Planned

A1	A2			
B1	B2	B3	B4	
C1	C2	C3	C4	
D1	<b>D2</b>	D3		
E1	E2	E3	E4	
F1	F2	F3	F4	F5
	G2	G3	G4	G5
		H3	H4	H5
		I3	I4	

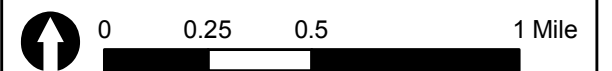

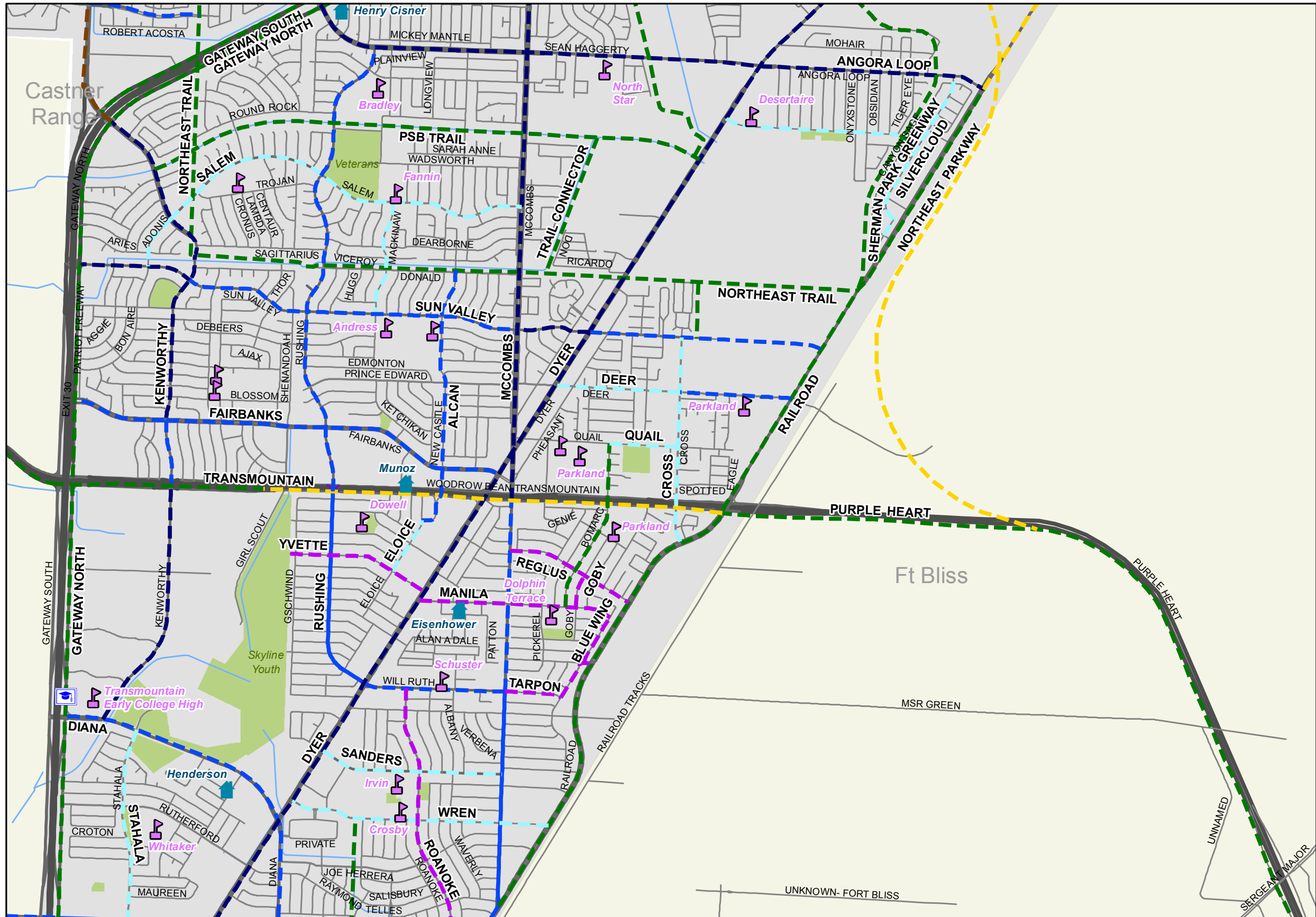

# D3

## Bicycle Facilities

- Existing**
- Shared Lane Markings
  - Shoulder Bikeway
  - Bike Lane
  - Buffered Bike Lane
  - Shared Use Path
- Proposed**
- Signed Shared Roadway
  - Shared Lane Markings
  - Bicycle Boulevard
  - Shoulder Bikeway
  - Bike Lane
  - Buffered Bike Lane
  - Protected Bike Lane / Cycle Track
  - Two-Way Cycle Track
  - Shared Use Path
  - Further Study Needed
- SunCycle Bike Share Station**
- Existing
  - Planned

A1	A2				
B1	B2	B3	B4		
C1	C2	C3	C4		
D1	D2	<b>D3</b>			
E1	E2	E3	E4		
F1	F2	F3	F4	F5	
		G2	G3	G4	G5
			H3	H4	H5
			I3	I4	

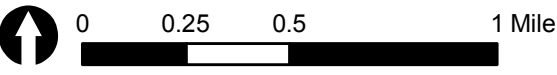



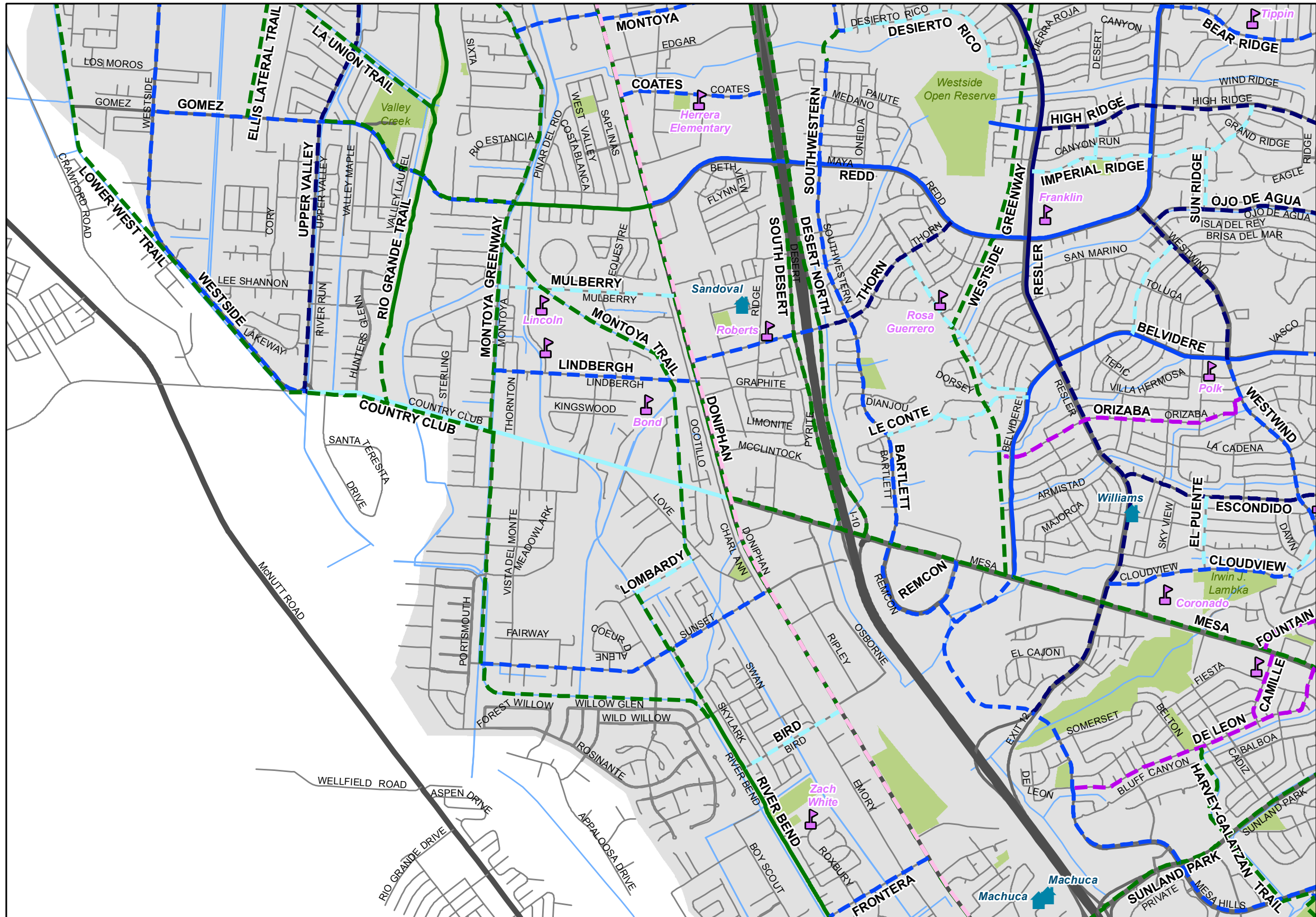

# E1

## Bicycle Facilities

- Existing**
- Shared Lane Markings
  - Shoulder Bikeway
  - Bike Lane
  - Buffered Bike Lane
  - Shared Use Path
- Proposed**
- Signed Shared Roadway
  - Shared Lane Markings
  - Bicycle Boulevard
  - Shoulder Bikeway
  - Bike Lane
  - Buffered Bike Lane
  - Protected Bike Lane / Cycle Track
  - Two-Way Cycle Track
  - Shared Use Path
  - Further Study Needed
- SunCycle Bike Share Station**
- Existing
  - Planned

A1	A2			
B1	B2	B3	B4	
C1	C2	C3	C4	
D1	D2	D3		
<b>E1</b>	E2	E3	E4	
F1	F2	F3	F4	F5
	G2	G3	G4	G5
		H3	H4	H5
		I3	I4	

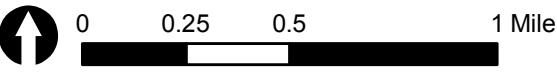

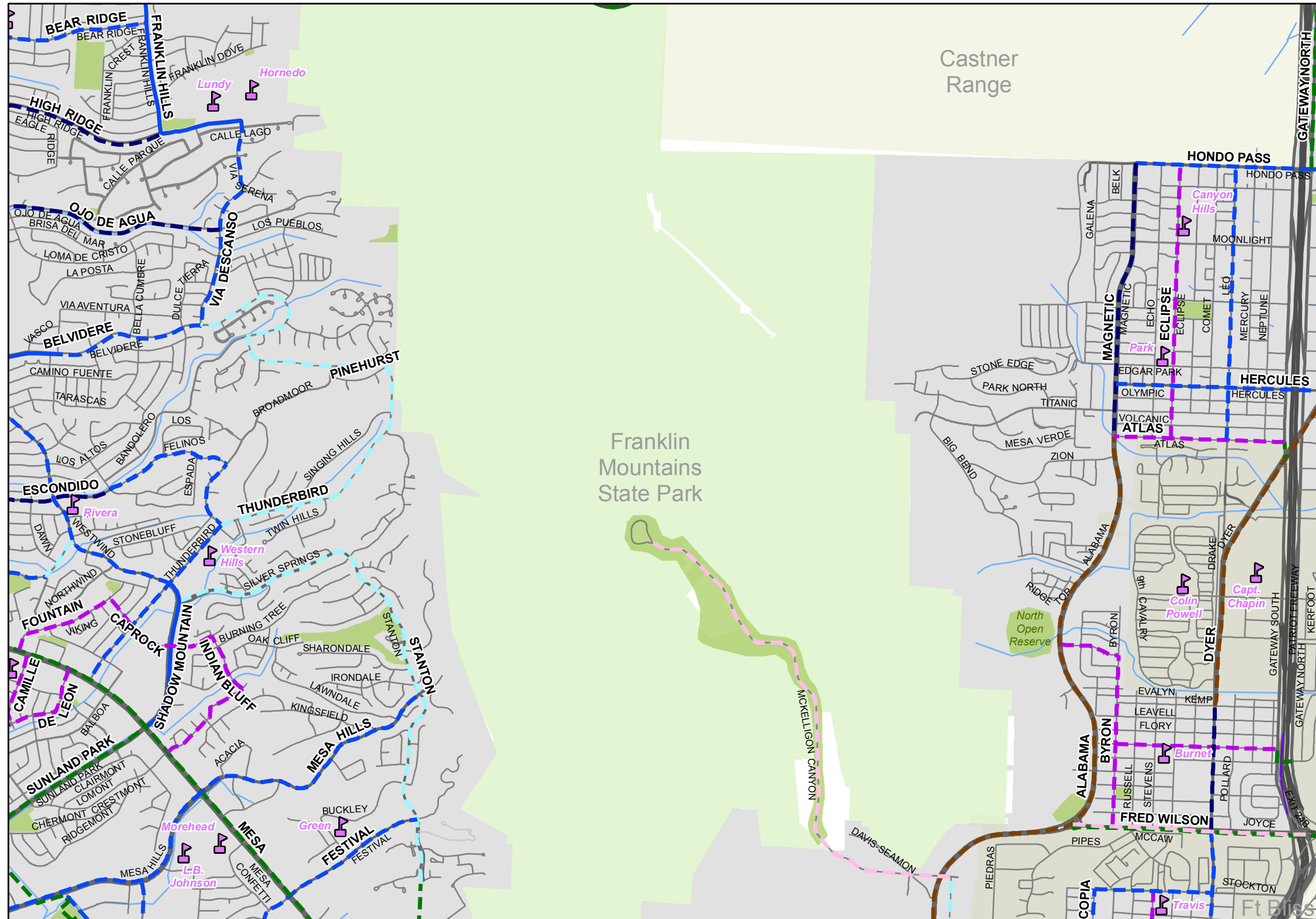

# E2

## Bicycle Facilities

### Existing

- Shared Lane Markings
- Shoulder Bikeway
- Bike Lane
- Buffered Bike Lane
- Shared Use Path

### Proposed

- Signed Shared Roadway
- Shared Lane Markings
- Bicycle Boulevard
- Shoulder Bikeway
- Bike Lane
- Buffered Bike Lane
- Protected Bike Lane / Cycle Track
- Two-Way Cycle Track
- Shared Use Path
- Further Study Needed

### SunCycle Bike Share Station

- Existing
- Planned

A1	A2			
B1	B2	B3	B4	
C1	C2	C3	C4	
D1	D2	D3		
E1	<b>E2</b>	E3	E4	
F1	F2	F3	F4	F5
	G2	G3	G4	G5
		H3	H4	H5
		I3	I4	

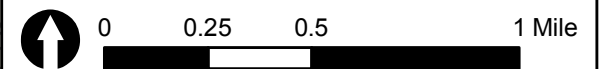



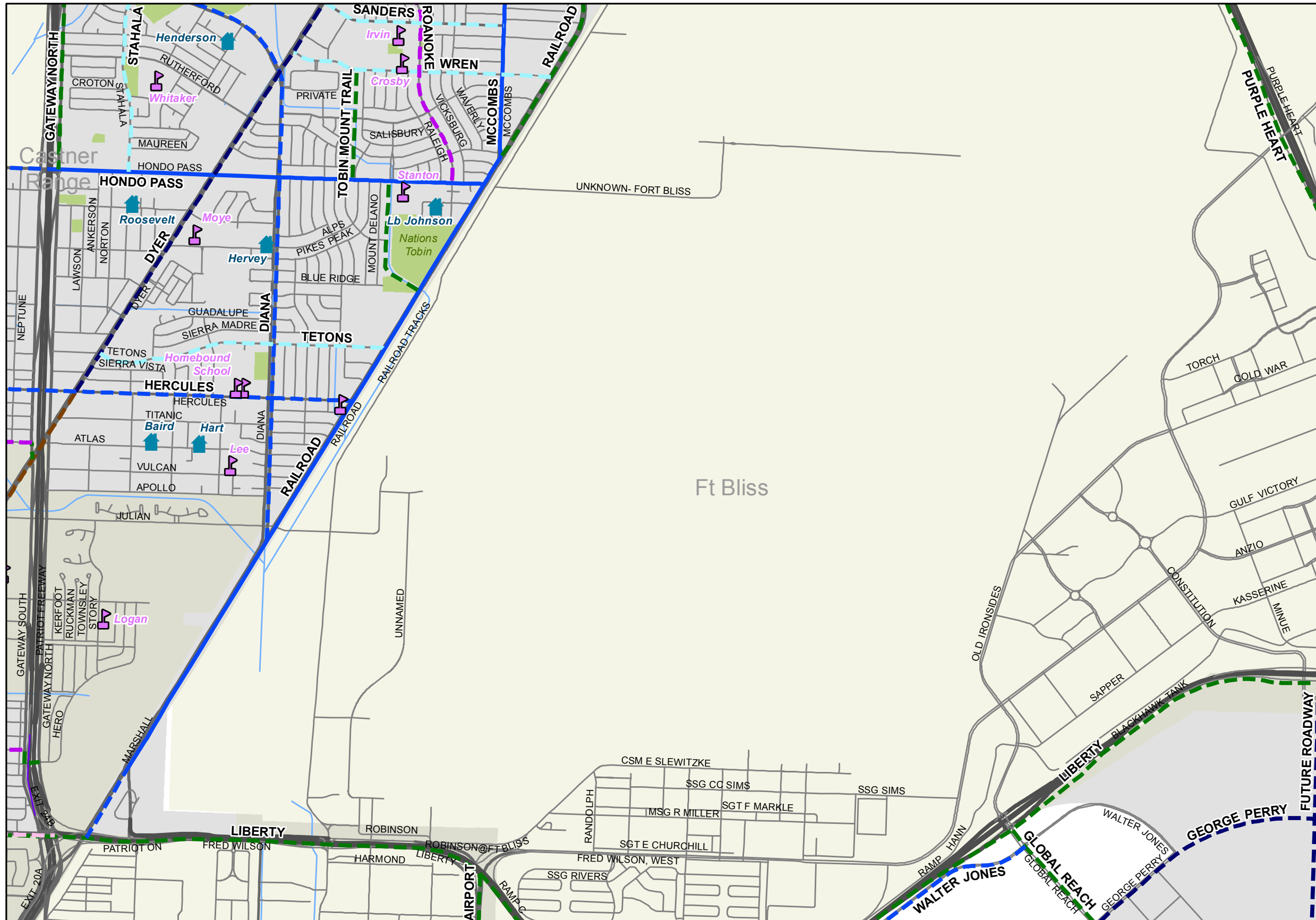

# E3

## Bicycle Facilities

### Existing

- Shared Lane Markings
- Shoulder Bikeway
- Bike Lane
- Buffered Bike Lane
- Shared Use Path

### Proposed

- - - Signed Shared Roadway
- - - Shared Lane Markings
- - - Bicycle Boulevard
- - - Shoulder Bikeway
- - - Bike Lane
- - - Buffered Bike Lane
- - - Protected Bike Lane / Cycle Track
- - - Two-Way Cycle Track
- - - Shared Use Path
- - - Further Study Needed

### SunCycle Bike Share Station

- ★ Existing
- ★ Planned

A1	A2			
B1	B2	B3	B4	
C1	C2	C3	C4	
D1	D2	D3		
E1	E2	E3	E4	
F1	F2	F3	F4	F5
	G2	G3	G4	G5
		H3	H4	H5
		I3	I4	

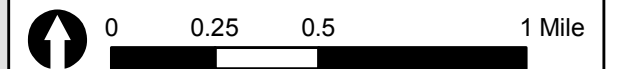

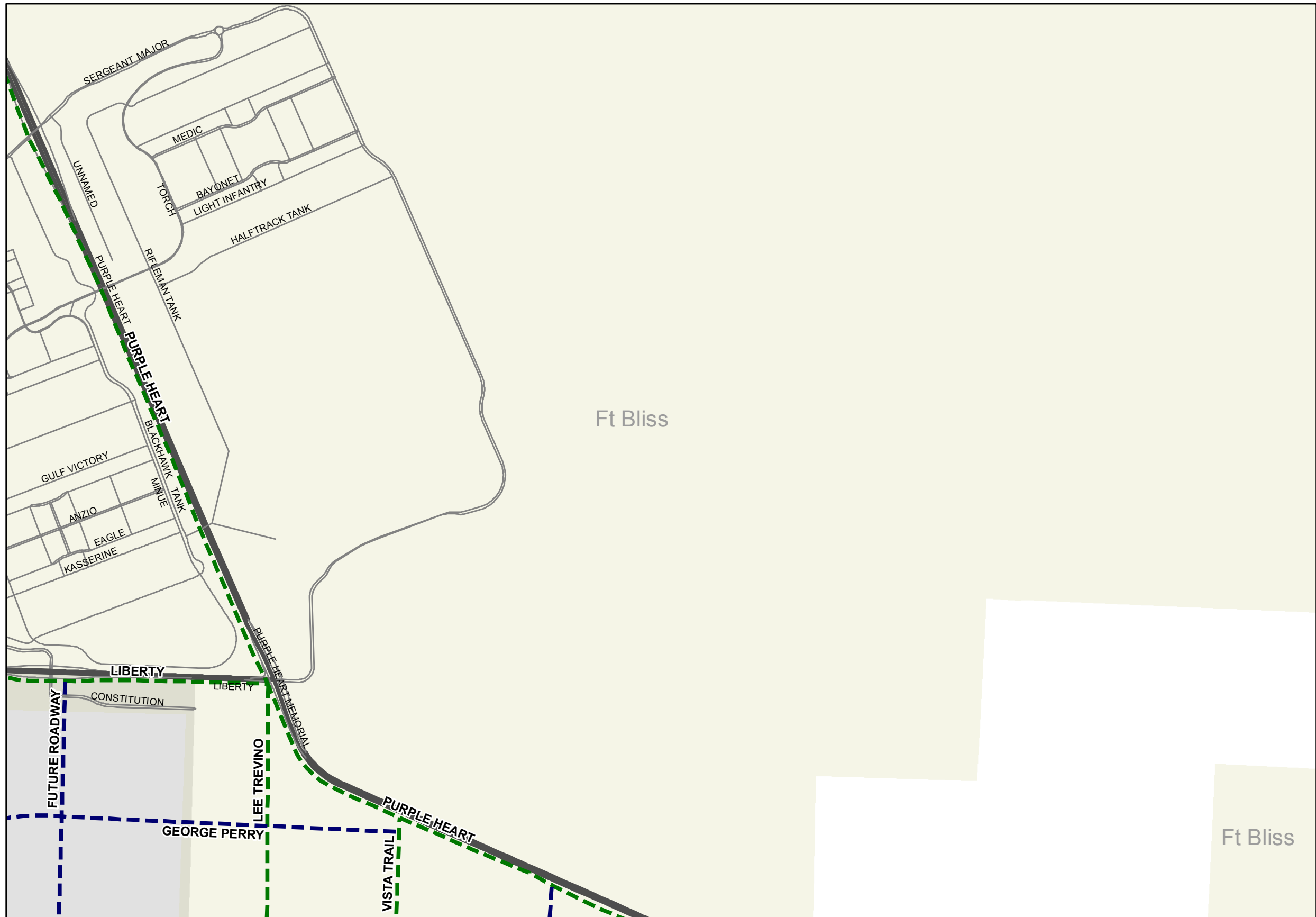

# E4

## Bicycle Facilities

- Existing**
- Shared Lane Markings
  - Shoulder Bikeway
  - Bike Lane
  - Buffered Bike Lane
  - Shared Use Path
- Proposed**
- Signed Shared Roadway
  - Shared Lane Markings
  - Bicycle Boulevard
  - Shoulder Bikeway
  - Bike Lane
  - Buffered Bike Lane
  - Protected Bike Lane / Cycle Track
  - Two-Way Cycle Track
  - Shared Use Path
  - Further Study Needed
- SunCycle Bike Share Station**
- Existing
  - Planned

A1	A2			
B1	B2	B3	B4	
C1	C2	C3	C4	
D1	D2	D3		
E1	E2	E3	<b>E4</b>	
F1	F2	F3	F4	F5
	G2	G3	G4	G5
		H3	H4	H5
		I3	I4	

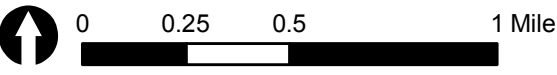

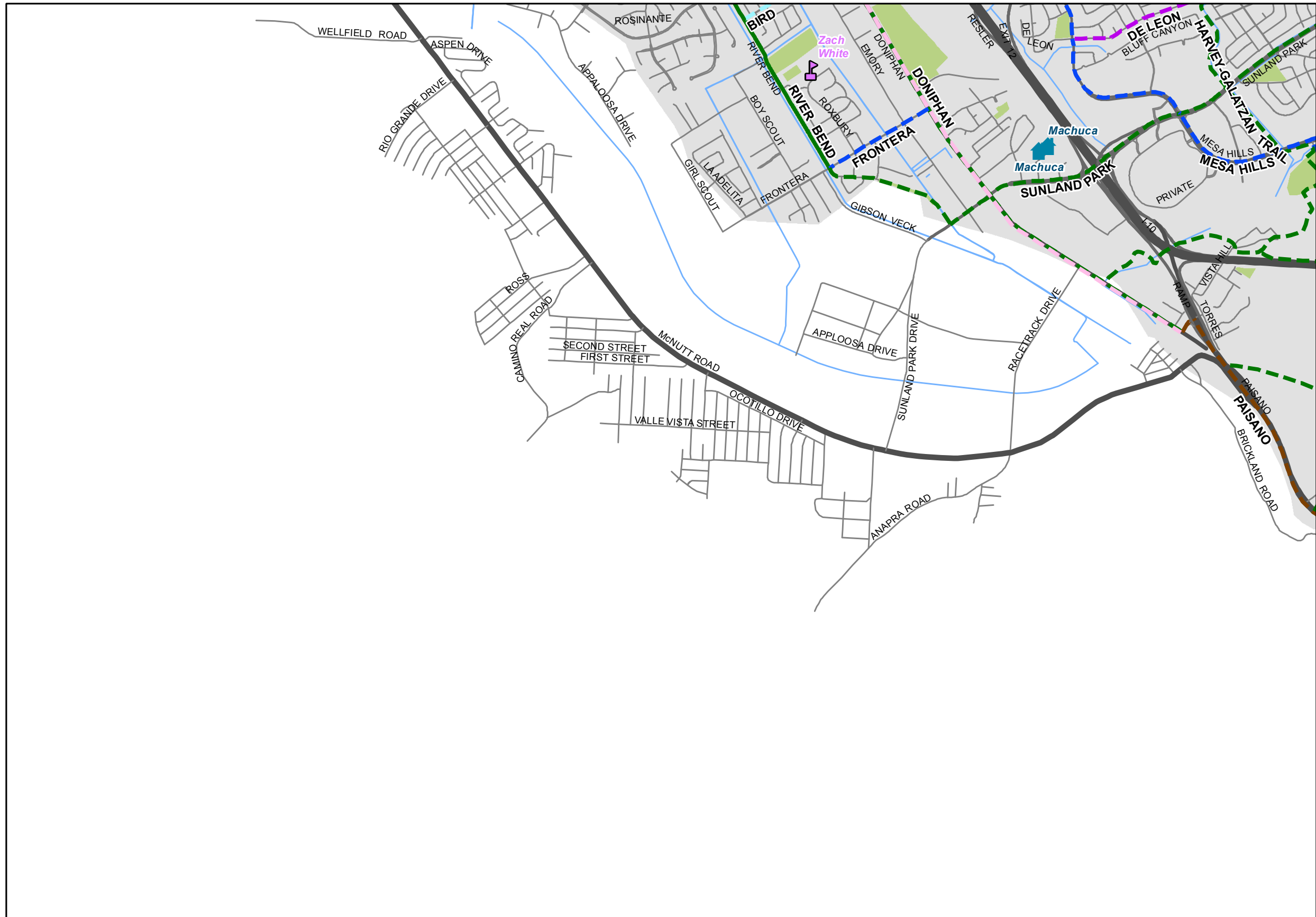

# F1

## Bicycle Facilities

- Existing**
- Shared Lane Markings
  - Shoulder Bikeway
  - Bike Lane
  - Buffered Bike Lane
  - Shared Use Path
- Proposed**
- Signed Shared Roadway
  - Shared Lane Markings
  - Bicycle Boulevard
  - Shoulder Bikeway
  - Bike Lane
  - Buffered Bike Lane
  - Protected Bike Lane / Cycle Track
  - Two-Way Cycle Track
  - Shared Use Path
  - Further Study Needed
- SunCycle Bike Share Station**
- Existing
  - Planned

A1	A2			
B1	B2	B3	B4	
C1	C2	C3	C4	
D1	D2	D3		
E1	E2	E3	E4	
<b>F1</b>	F2	F3	F4	F5
	G2	G3	G4	G5
		H3	H4	H5
		I3	I4	

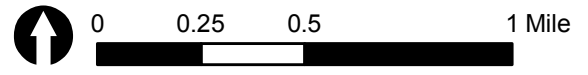



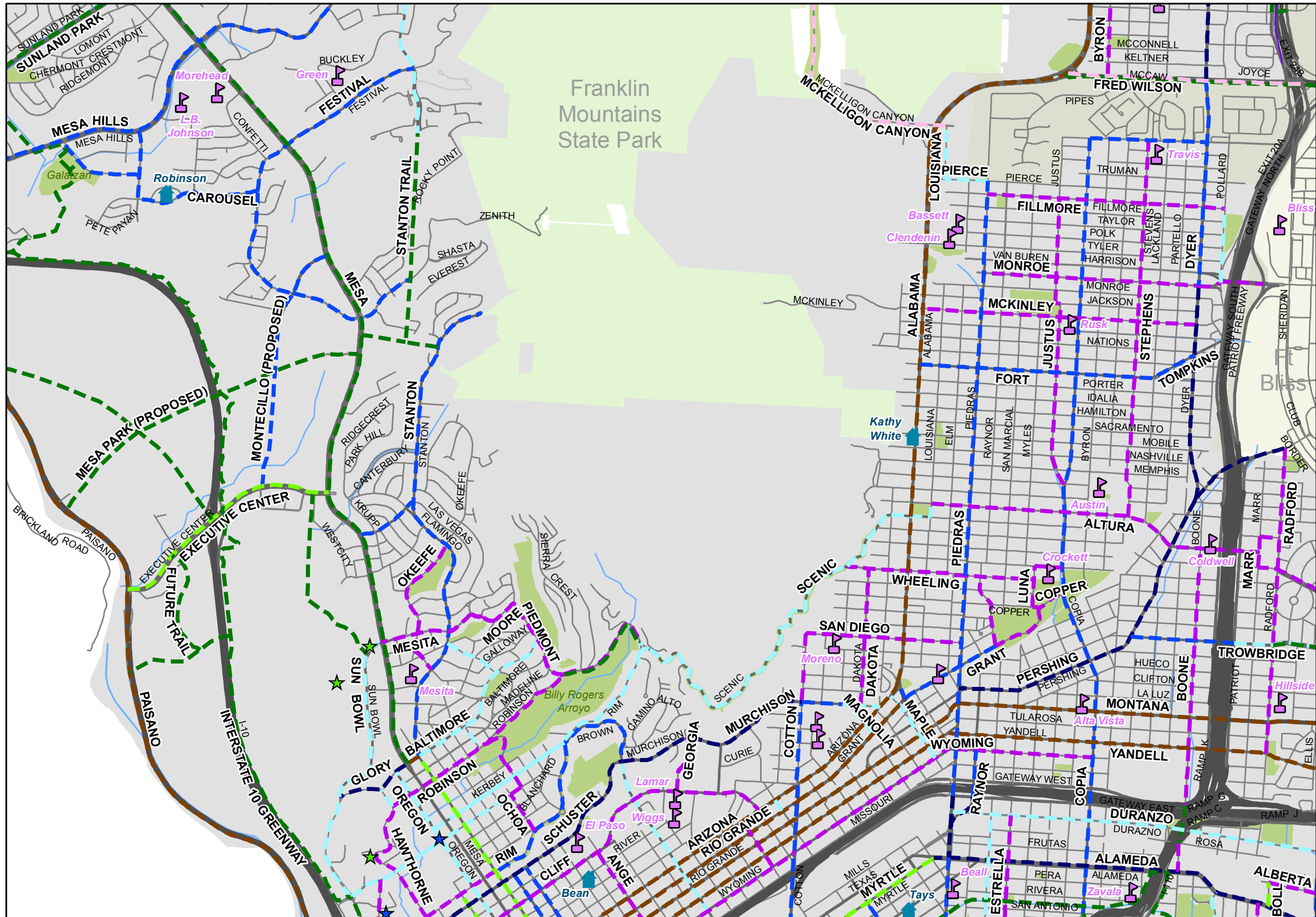

# F2

## Bicycle Facilities

- Existing**
- Shared Lane Markings
  - Shoulder Bikeway
  - Bike Lane
  - Buffered Bike Lane
  - Shared Use Path
- Proposed**
- Signed Shared Roadway
  - Shared Lane Markings
  - Bicycle Boulevard
  - Shoulder Bikeway
  - Bike Lane
  - Buffered Bike Lane
  - Protected Bike Lane / Cycle Track
  - Two-Way Cycle Track
  - Shared Use Path
  - Further Study Needed
- SunCycle Bike Share Station**
- ★ Existing
  - ★ Planned

A1	A2			
B1	B2	B3	B4	
C1	C2	C3	C4	
D1	D2	D3		
E1	E2	E3	E4	
F1	<b>F2</b>	F3	F4	F5
	G2	G3	G4	G5
		H3	H4	H5
		I3	I4	

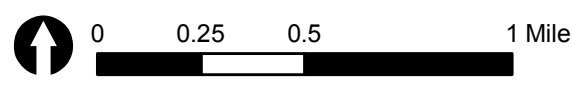



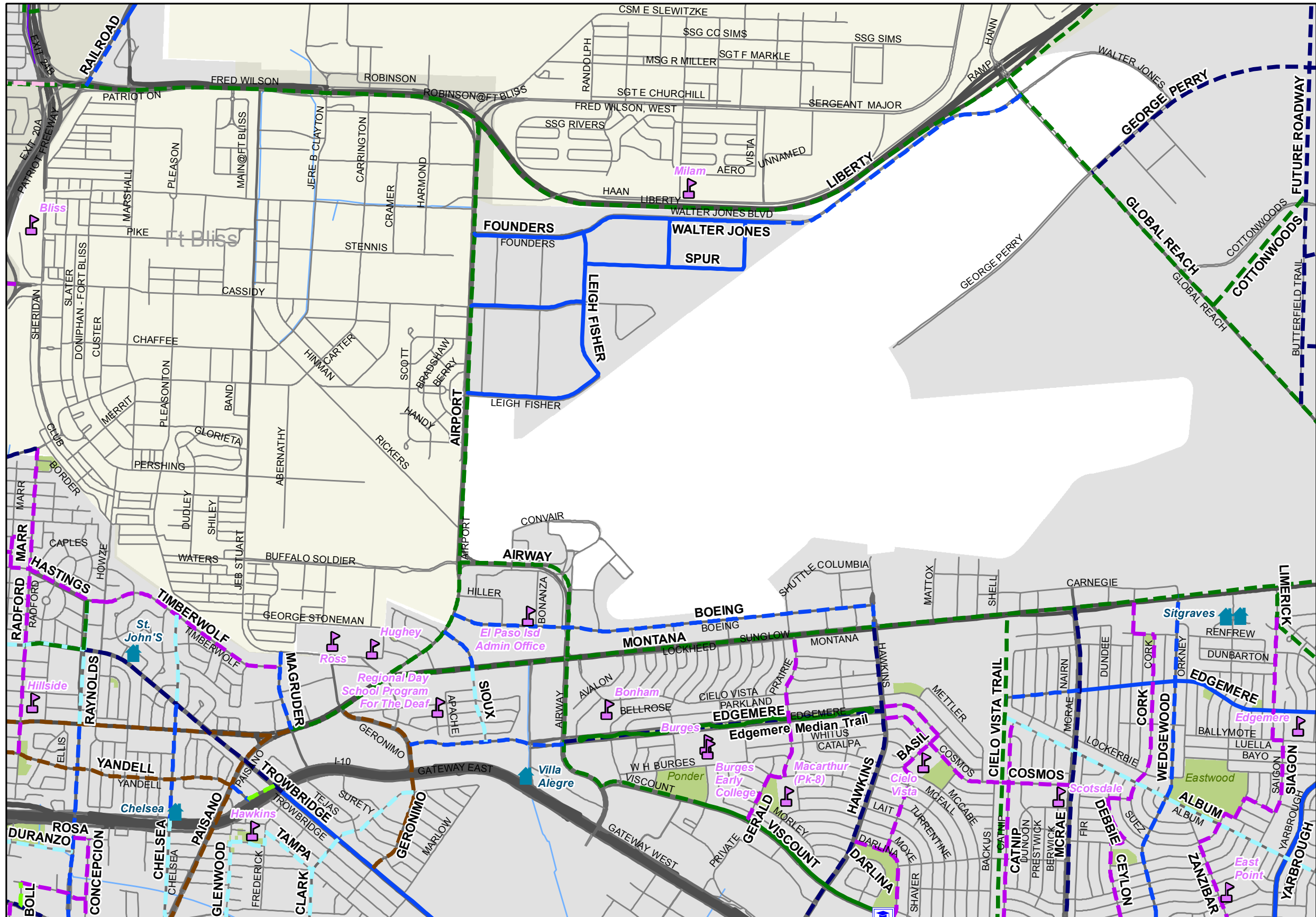

# F3

## Bicycle Facilities

- Existing**
- Shared Lane Markings
  - Shoulder Bikeway
  - Bike Lane
  - Buffered Bike Lane
  - Shared Use Path
- Proposed**
- - - Signed Shared Roadway
  - - - Shared Lane Markings
  - - - Bicycle Boulevard
  - - - Shoulder Bikeway
  - - - Bike Lane
  - - - Buffered Bike Lane
  - - - Protected Bike Lane / Cycle Track
  - - - Two-Way Cycle Track
  - - - Shared Use Path
  - - - Further Study Needed

## SunCycle Bike Share Station

- ★ Existing
- ★ Planned

A1	A2		
B1	B2	B3	B4
C1	C2	C3	C4
D1	D2	D3	
E1	E2	E3	E4
F1	F2	F3	F4
	G2	G3	G4
		H3	H4
		I3	I4

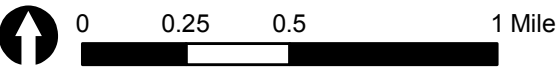

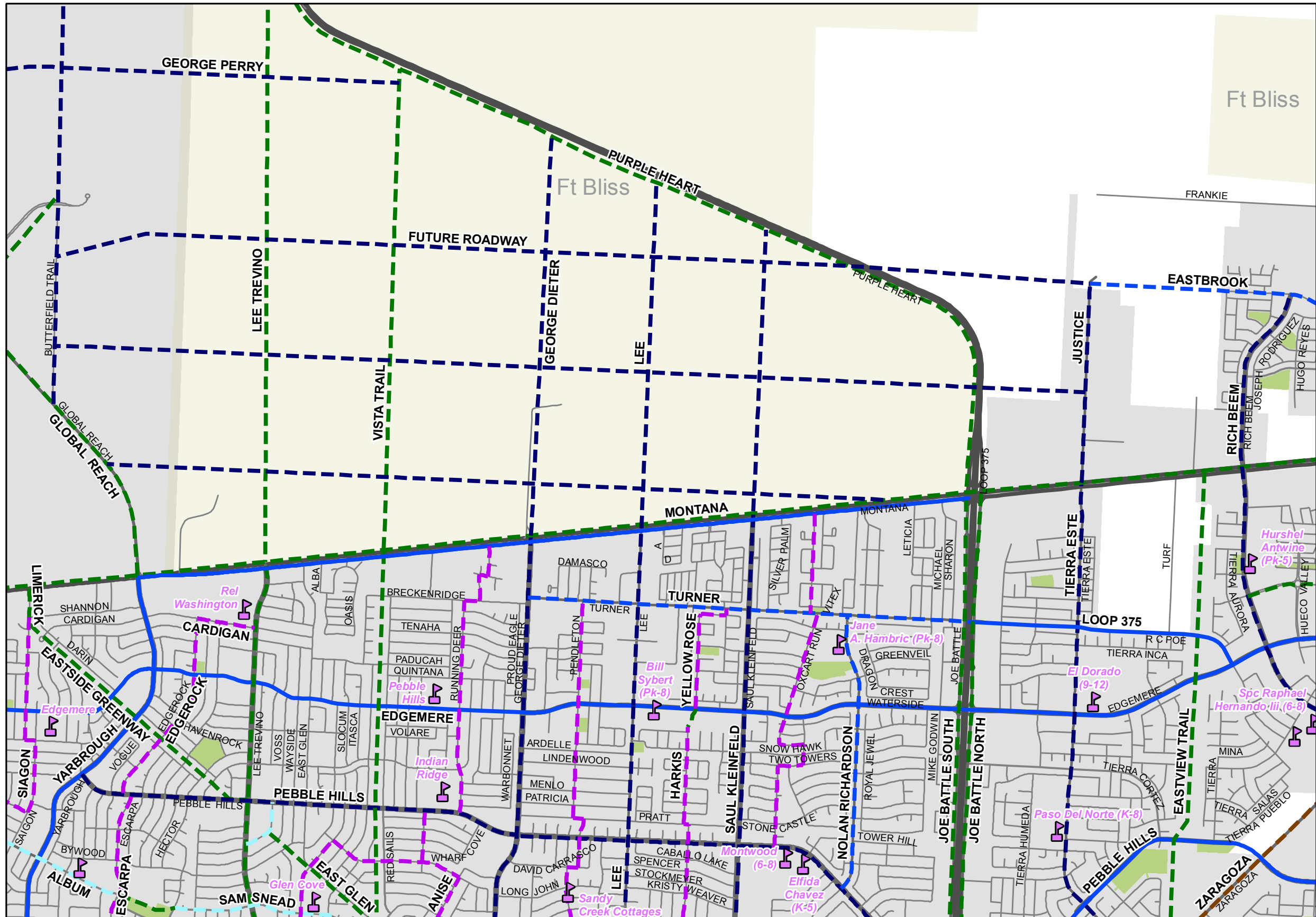

# F4

## Bicycle Facilities

### Existing

- Shared Lane Markings
- Shoulder Bikeway
- Bike Lane
- Buffered Bike Lane
- Shared Use Path

### Proposed

- Signed Shared Roadway
- Shared Lane Markings
- Bicycle Boulevard
- Shoulder Bikeway
- Bike Lane
- Buffered Bike Lane
- Protected Bike Lane / Cycle Track
- Two-Way Cycle Track
- Shared Use Path
- Further Study Needed

### SunCycle Bike Share Station

- Existing
- Planned

A1	A2			
B1	B2	B3	B4	
C1	C2	C3	C4	
D1	D2	D3		
E1	E2	E3	E4	
F1	F2	F3	<b>F4</b>	F5
	G2	G3	G4	G5
		H3	H4	H5
		I3	I4	

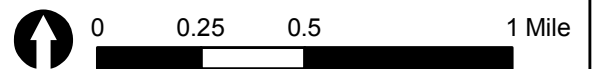





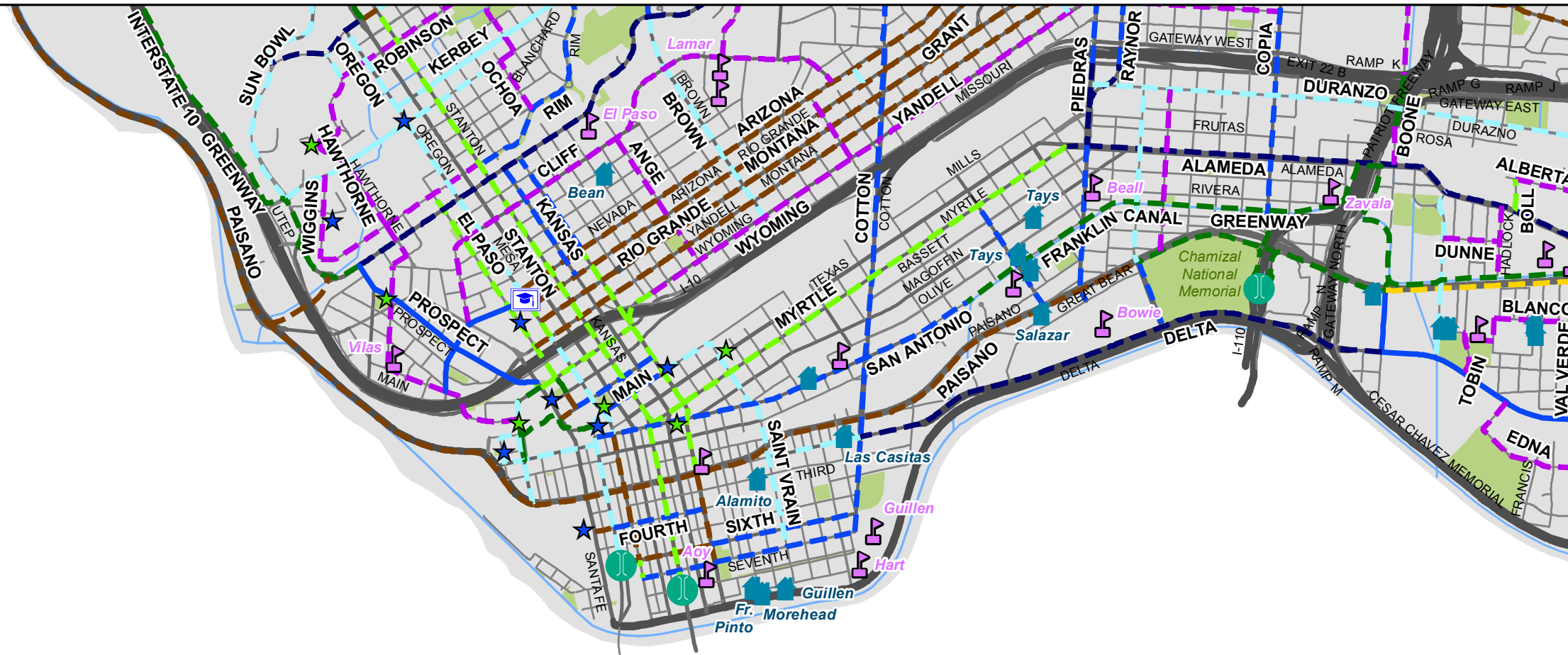

# G2

## Bicycle Facilities

### Existing

- Shared Lane Markings
- Shoulder Bikeway
- Bike Lane
- Buffered Bike Lane
- Shared Use Path

### Proposed

- Signed Shared Roadway
- Shared Lane Markings
- Bicycle Boulevard
- Shoulder Bikeway
- Bike Lane
- Buffered Bike Lane
- Protected Bike Lane / Cycle Track
- Two-Way Cycle Track
- Shared Use Path
- Further Study Needed

### SunCycle Bike Share Station

- Existing
- Planned

A1	A2			
B1	B2	B3	B4	
C1	C2	C3	C4	
D1	D2	D3		
E1	E2	E3	E4	
F1	F2	F3	F4	F5
	<b>G2</b>	G3	G4	G5
		H3	H4	H5
		I3	I4	

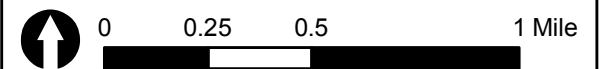



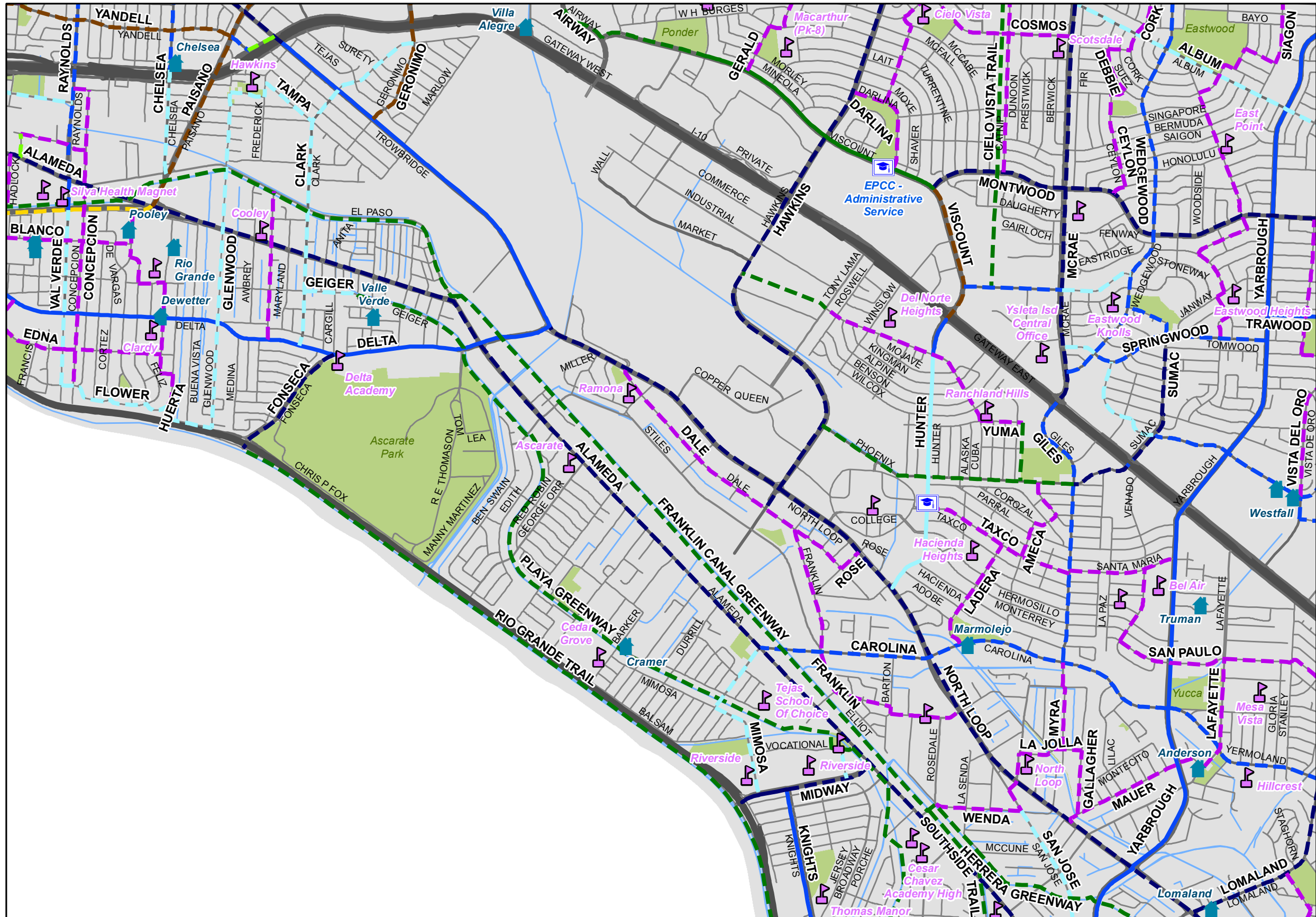

# G3

## Bicycle Facilities

- Existing**
- Shared Lane Markings
  - Shoulder Bikeway
  - Bike Lane
  - Buffered Bike Lane
  - Shared Use Path
- Proposed**
- Signed Shared Roadway
  - Shared Lane Markings
  - Bicycle Boulevard
  - Shoulder Bikeway
  - Bike Lane
  - Buffered Bike Lane
  - Protected Bike Lane / Cycle Track
  - Two-Way Cycle Track
  - Shared Use Path
  - Further Study Needed
- SunCycle Bike Share Station**
- Existing
  - Planned

A1	A2			
B1	B2	B3	B4	
C1	C2	C3	C4	
D1	D2	D3		
E1	E2	E3	E4	
F1	F2	F3	F4	F5
	G2	<b>G3</b>	G4	G5
		H3	H4	H5
		I3	I4	

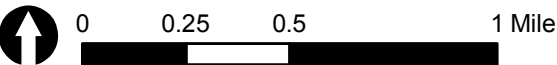



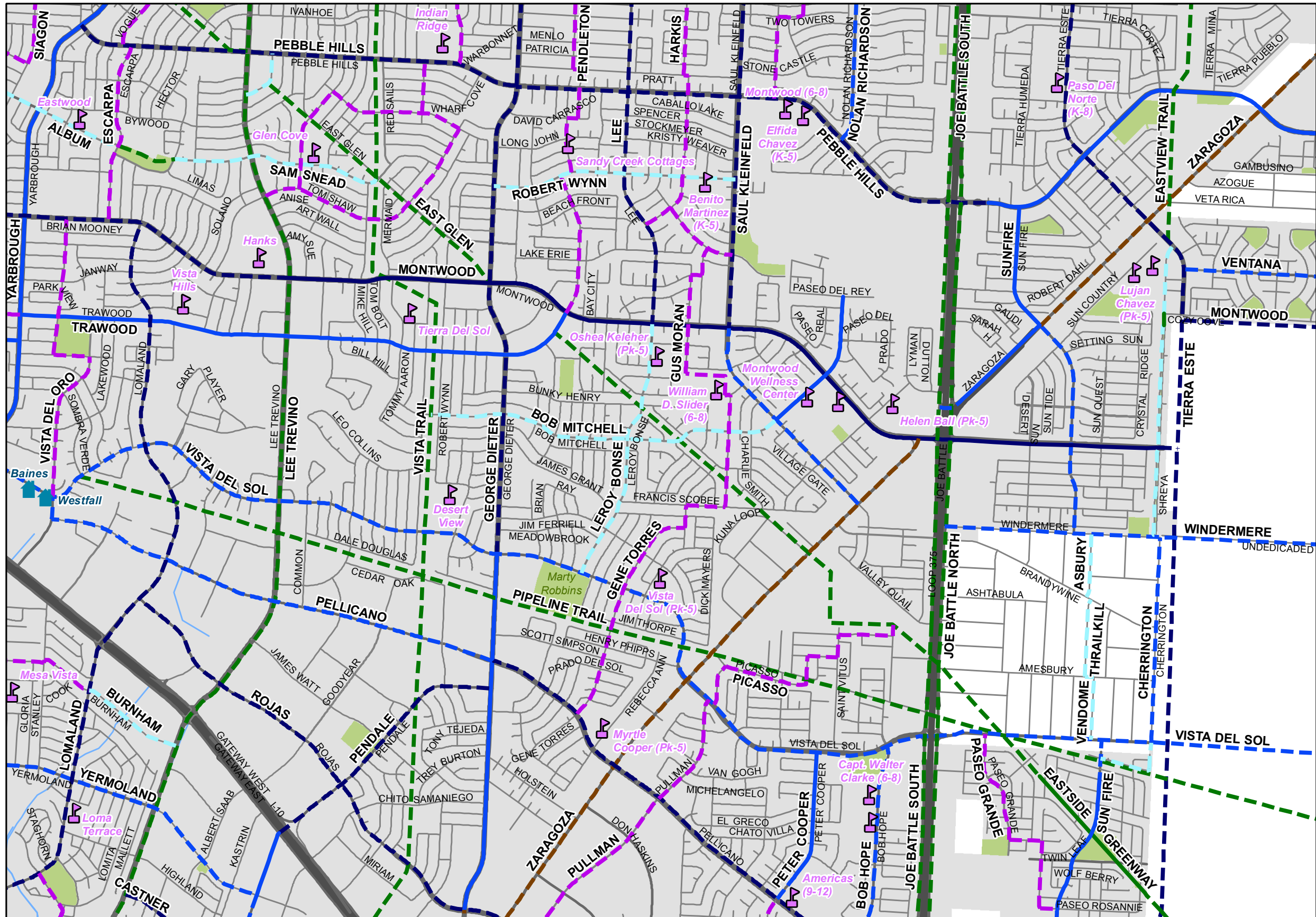

# G4

## Bicycle Facilities

- Existing**
- Shared Lane Markings
  - Shoulder Bikeway
  - Bike Lane
  - Buffered Bike Lane
  - Shared Use Path
- Proposed**
- Signed Shared Roadway
  - Shared Lane Markings
  - Bicycle Boulevard
  - Shoulder Bikeway
  - Bike Lane
  - Buffered Bike Lane
  - Protected Bike Lane / Cycle Track
  - Two-Way Cycle Track
  - Shared Use Path
  - Further Study Needed
- SunCycle Bike Share Station**
- Existing
  - Planned

A1	A2			
B1	B2	B3	B4	
C1	C2	C3	C4	
D1	D2	D3		
E1	E2	E3	E4	
F1	F2	F3	F4	F5
	G2	G3	<b>G4</b>	G5
		H3	H4	H5
		I3	I4	

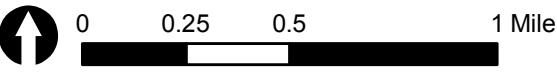



# G5

## Bicycle Facilities

- Existing
- Shared Lane Markings
  - Shoulder Bikeway
  - Bike Lane
  - Buffered Bike Lane
  - Shared Use Path

- Proposed
- Signed Shared Roadway
  - Shared Lane Markings
  - Bicycle Boulevard
  - Shoulder Bikeway
  - Bike Lane
  - Buffered Bike Lane
  - Protected Bike Lane / Cycle Track
  - Two-Way Cycle Track
  - Shared Use Path
  - Further Study Needed

- SunCycle Bike Share Station
- Existing
  - Planned

A1	A2			
B1	B2	B3	B4	
C1	C2	C3	C4	
D1	D2	D3		
E1	E2	E3	E4	
F1	F2	F3	F4	F5
	G2	G3	G4	<b>G5</b>
		H3	H4	H5
		I3	I4	

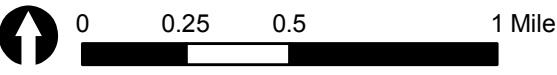



# H3

## Bicycle Facilities

### Existing

- Shared Lane Markings
- Shoulder Bikeway
- Bike Lane
- Buffered Bike Lane
- Shared Use Path

### Proposed

- Signed Shared Roadway
- Shared Lane Markings
- Bicycle Boulevard
- Shoulder Bikeway
- Bike Lane
- Buffered Bike Lane
- Protected Bike Lane / Cycle Track
- Two-Way Cycle Track
- Shared Use Path
- Further Study Needed

### SunCycle Bike Share Station

- Existing
- Planned

A1	A2			
B1	B2	B3	B4	
C1	C2	C3	C4	
D1	D2	D3		
E1	E2	E3	E4	
F1	F2	F3	F4	F5
	G2	G3	G4	G5
		H3	H4	H5
		I3	I4	

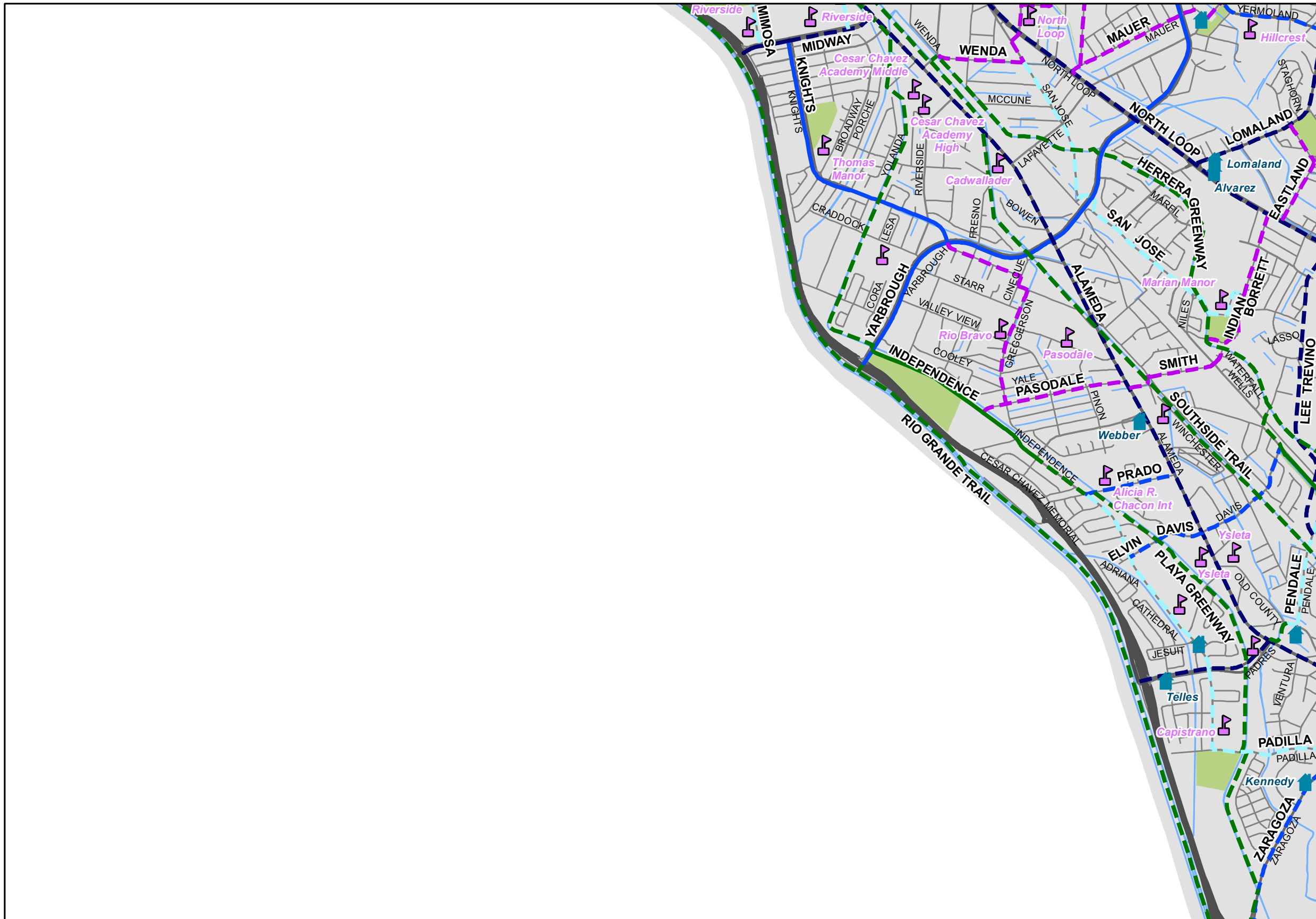
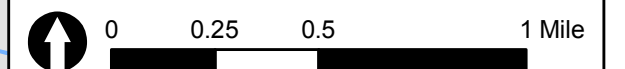



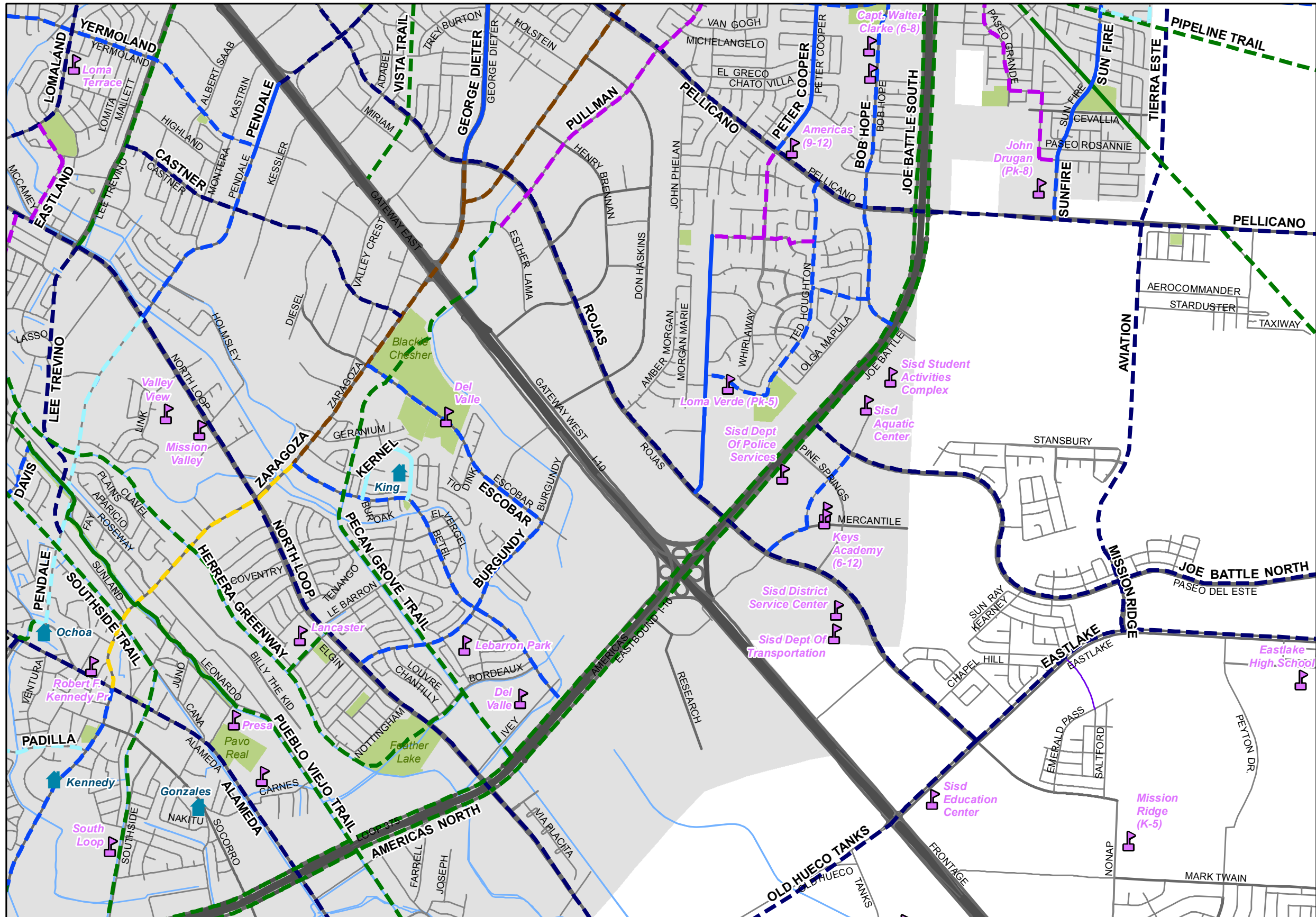

# H4

## Bicycle Facilities

- Existing**
- Shared Lane Markings
  - Shoulder Bikeway
  - Bike Lane
  - Buffered Bike Lane
  - Shared Use Path

- Proposed**
- Signed Shared Roadway
  - Shared Lane Markings
  - Bicycle Boulevard
  - Shoulder Bikeway
  - Bike Lane
  - Buffered Bike Lane
  - Protected Bike Lane / Cycle Track
  - Two-Way Cycle Track
  - Shared Use Path
  - Further Study Needed

- SunCycle Bike Share Station**
- Existing
  - Planned

A1	A2			
B1	B2	B3	B4	
C1	C2	C3	C4	
D1	D2	D3		
E1	E2	E3	E4	
F1	F2	F3	F4	F5
	G2	G3	G4	G5
		H3	H4	H5
		I3	I4	

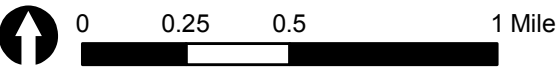

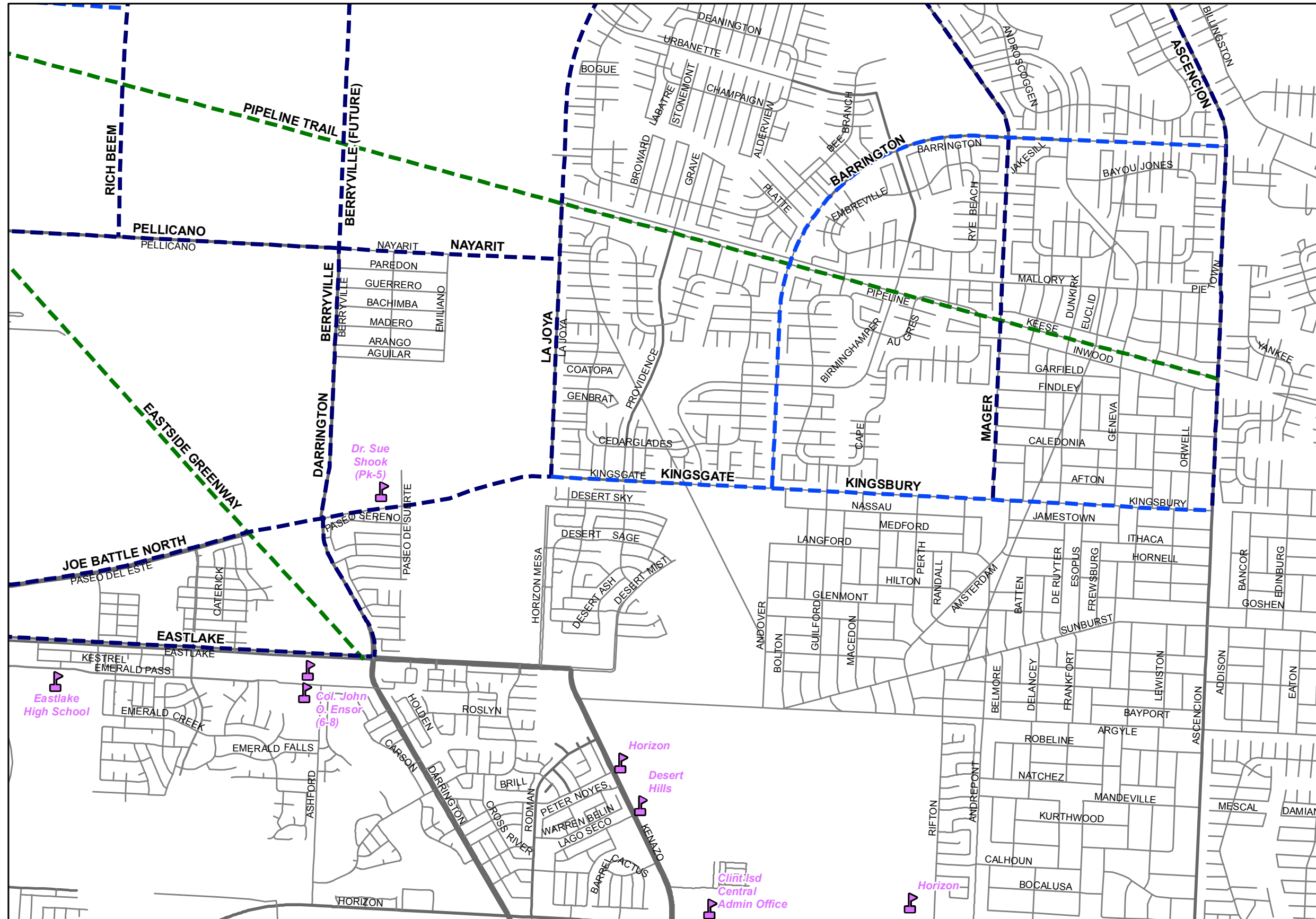

# H5

## Bicycle Facilities

### Existing

- Shared Lane Markings
- Shoulder Bikeway
- Bike Lane
- Buffered Bike Lane
- Shared Use Path

### Proposed

- Signed Shared Roadway
- Shared Lane Markings
- Bicycle Boulevard
- Shoulder Bikeway
- Bike Lane
- Buffered Bike Lane
- Protected Bike Lane / Cycle Track
- Two-Way Cycle Track
- Shared Use Path
- Further Study Needed

### SunCycle Bike Share Station

- Existing
- Planned

A1	A2				
B1	B2	B3	B4		
C1	C2	C3	C4		
D1	D2	D3			
E1	E2	E3	E4		
F1	F2	F3	F4	F5	
		G2	G3	G4	G5
			H3	H4	H5
			I3	I4	

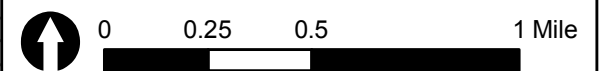

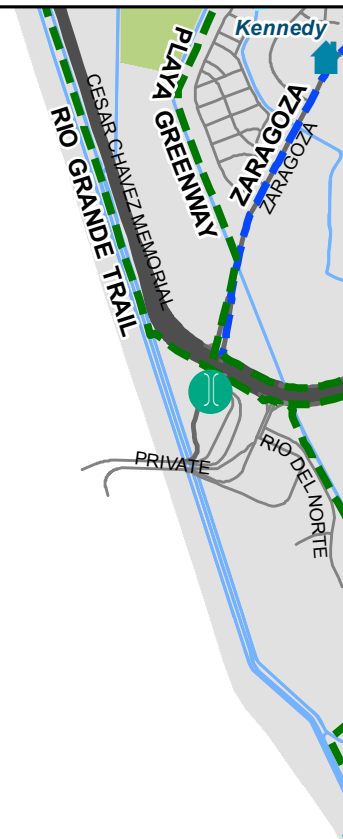

# I3

## Bicycle Facilities

### Existing

- Shared Lane Markings
- Shoulder Bikeway
- Bike Lane
- Buffered Bike Lane
- Shared Use Path

### Proposed

- Signed Shared Roadway
- Shared Lane Markings
- Bicycle Boulevard
- Shoulder Bikeway
- Bike Lane
- Buffered Bike Lane
- Protected Bike Lane / Cycle Track
- Two-Way Cycle Track
- Shared Use Path
- Further Study Needed

### SunCycle Bike Share Station

- Existing
- Planned

A1	A2			
B1	B2	B3	B4	
C1	C2	C3	C4	
D1	D2	D3		
E1	E2	E3	E4	
F1	F2	F3	F4	F5
	G2	G3	G4	G5
		H3	H4	H5
		I3	I4	

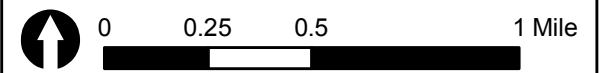



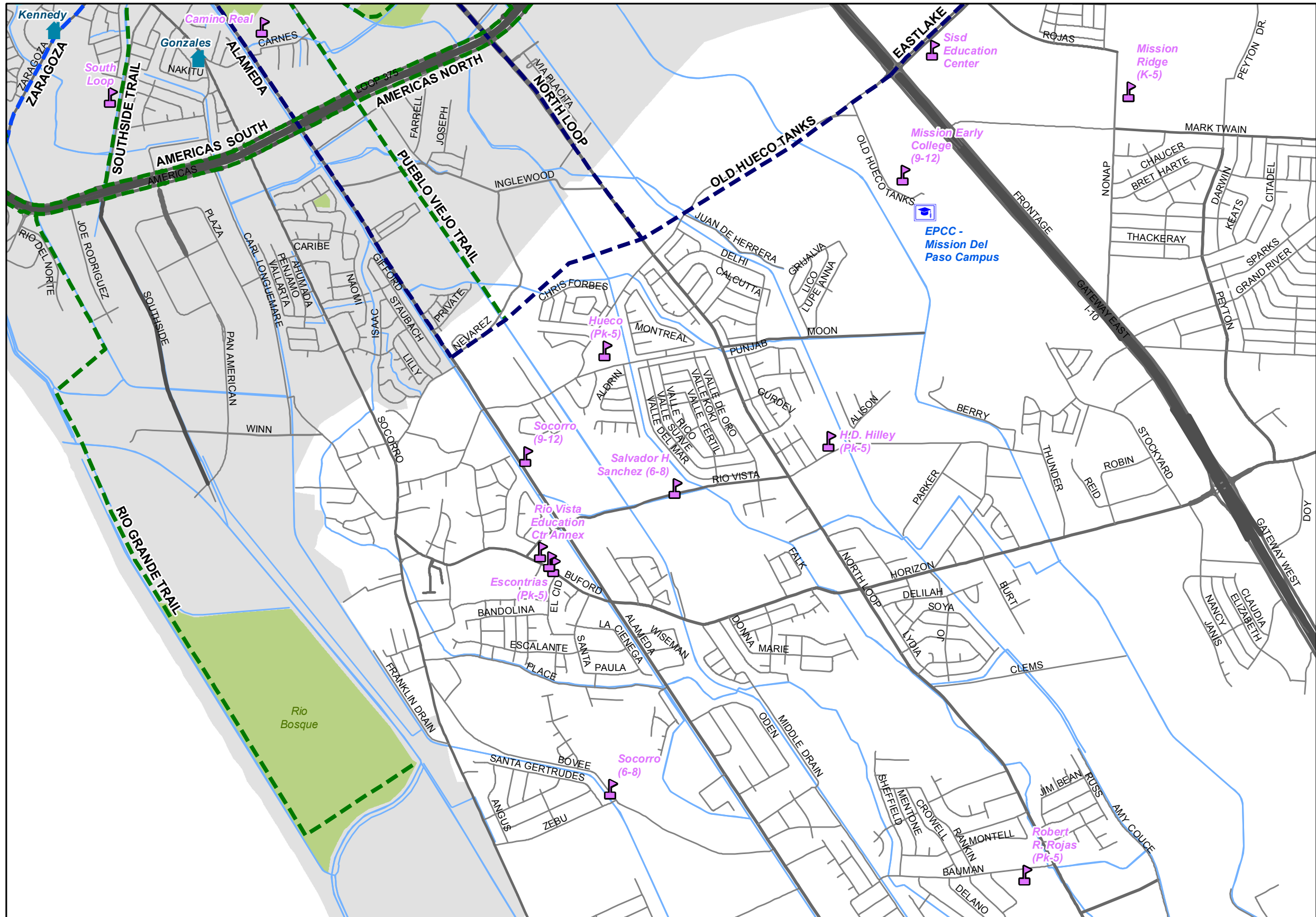

# 14

## Bicycle Facilities

- Existing**
- Shared Lane Markings
  - Shoulder Bikeway
  - Bike Lane
  - Buffered Bike Lane
  - Shared Use Path

- Proposed**
- Signed Shared Roadway
  - Shared Lane Markings
  - Bicycle Boulevard
  - Shoulder Bikeway
  - Bike Lane
  - Buffered Bike Lane
  - Protected Bike Lane / Cycle Track
  - Two-Way Cycle Track
  - Shared Use Path
  - Further Study Needed

- SunCycle Bike Share Station**
- Existing
  - Planned

A1	A2			
B1	B2	B3	B4	
C1	C2	C3	C4	
D1	D2	D3		
E1	E2	E3	E4	
F1	F2	F3	F4	F5
	G2	G3	G4	G5
		H3	H4	H5
		I3	I4	

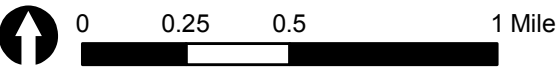





## Appendix C: Design Guidelines

This page left blank intentionally.

## Table of Contents

Bike Box .....	C4
Two-Stage Turn Boxes .....	C6
Bike Lanes at Intersections where Right Turns Are Permitted .....	C8
Bike Lanes at Added Right Turn Lanes . . . .	C10
Bike Lanes at Through Lane to Right Turn Lane Transition .....	C12
Combined Bike Lane/Turn Lane .....	C14
Mixing Zone .....	C16
Protected Bicycle Signal Phase .....	C18
Bike Lanes at Channelized Turn Lanes. . . .	C20
Bike Lanes at Entrance Ramps .....	C22
Bike Lanes at Exit Ramps .....	C24
Bicycle Detection and Actuation .....	C26
Driveways and Minor Streets .....	C28
Bicycle Priority at Signals .....	C30
Bicycle Boulevards .....	C32
Protected Intersections .....	C34



## Bike Box

A bike box is a designated area located at the head of a traffic lane at a signalized intersection that provides bicyclists with a safe and visible space to get in front of queuing traffic during the red signal phase. Motor vehicles must queue behind the white stop line at the rear of the bike box. On a green signal, all bicyclists can quickly clear the intersection.

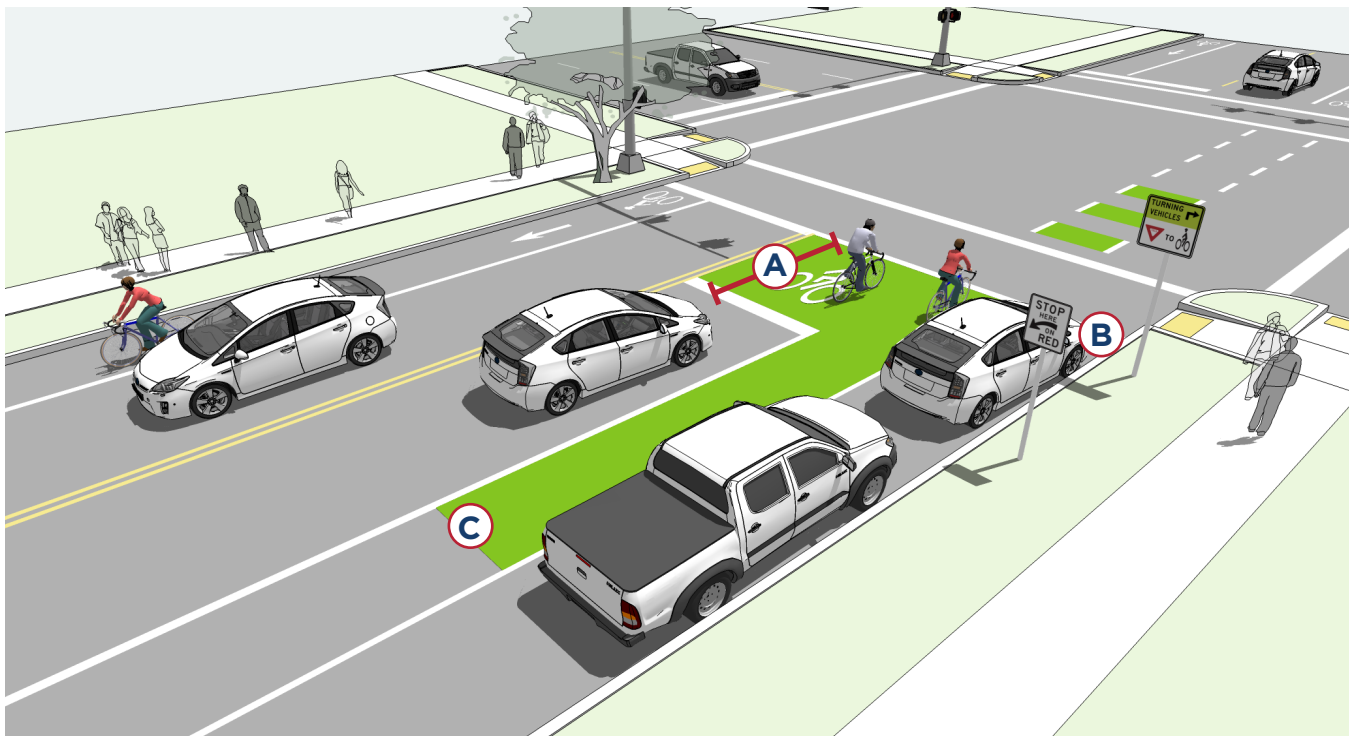

### Typical Application

- At potential areas of conflict between bicyclists and turning vehicles, such as a right or left turn locations
- At signalized intersections with high bicycle volumes
- At signalized intersections with high vehicle volumes

### Design Features

- A** 14 foot minimum depth from back of crosswalk to motor vehicle stop bar. (NACTO, 2012)
- B** A “No Turn on Red” (TMUTCD R10-11) sign shall be installed overhead to prevent vehicles from entering the Bike Box. (Refer to TMUTCD Table 2B-1 for the signage). A “Stop Here on Red” (TMUTCD R10-6) sign should be post mounted at the stop line to reinforce observance of the stop line.
- C** A 50 foot ingress lane should be used to provide access to the box.

Use of green-colored pavement is optional.



*Figure C1. A bike box allows for cyclists to wait in front of queuing traffic, providing high visibility and a head start over motor vehicle traffic.*

## Further Considerations

- This treatment positions bicycles together and on a green signal, all bicyclists can quickly clear the intersection, minimizing conflict and delay to transit or other traffic.
- Pedestrian also benefit from bike boxes, as they experience reduced vehicle encroachment into the crosswalk.
- Bike boxes are currently under experiment in some states.

## Crash Reduction

A study of motorist/bicyclist conflicts at bike boxes indicate a 35 percent decrease in conflicts. (CMF ID: 1718) A study done in Portland in 2010 found that 77 percent of bicyclists felt bicycling through intersections was safer with the bike boxes.<sup>1</sup>

## Construction Costs

Costs will vary due to the type of paint used and the size of the bike box, as well as whether the treatment is added at the same time as other road treatments.

The typical cost for painting a bike box is \$11.50 per square foot.

<sup>1</sup> Monsere, C. & Dill, J. (2010). Evaluation of Bike Boxes at Signalized Intersections. Final Draft. Oregon Transportation Research and education Consortium.

## Two-Stage Turn Boxes

Two-stage turn boxes offer bicyclists a safe way to make turns at multi-lane signalized intersections from a physically separated or conventional bike lane. On physically separated bike lanes, bicyclists are often unable to merge into traffic to turn due to physical separation, making the provision of two-stage turn boxes critical.

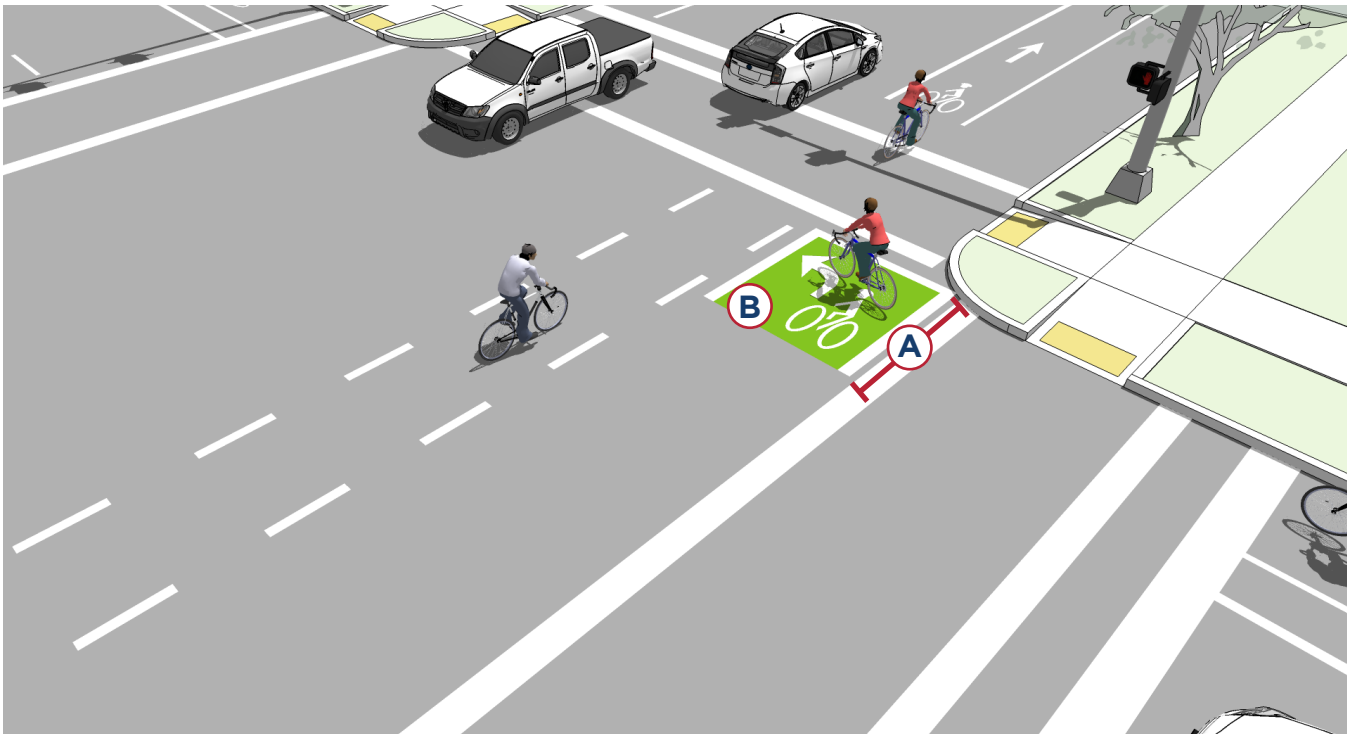

### Typical Application

- Streets with high vehicle speeds and/or traffic volumes.
- At intersections with multi-lane roads with signalized intersections.
- At signalized intersections with a high number of bicyclists making a left turn from a right side facility.

### Design Features

The two-stage turn box shall be placed in a protected area. Typically this is within the shadow of an on-street parking lane or protected bike lane buffer area and should be placed in front of the crosswalk to avoid conflict with pedestrians.

- Ⓐ 8 foot x 6 foot preferred depth of bicycle storage area (6 foot x 3 foot minimum).
- Ⓑ Bicycle stencil and turn arrow pavement markings shall be used to indicate proper bicycle direction and positioning. (NACTO, 2012)

Figure C4. Jughandle Turn Box



Figure C2. This MUTCD compliant design curves a jughandle out of the sidewalk to provide space for waiting bicyclists.

Figure C5. Separated Bike Lane Turn Box



Figure C3. On separated bike lanes, the two-stage turn box can be located in the protected buffer/parking area.

## Further Considerations

- Consider providing a “No Turn on Red” (TMUTCD R10-11) on the cross street to prevent motor vehicles from entering the turn box.
- This design formalizes a maneuver called a “box turn” or “pedestrian style turn.”
- Some two-stage turn box designs are considered experimental by FHWA.
- Design guidance for two-stage turns apply to both bike lanes and separated bike lanes.
- Two-stage turn boxes reduce conflicts in multiple ways; from keeping bicyclists from queuing in a bike lane or crosswalk and by separating turning bicyclists from through bicyclists.
- Bicyclist capacity of a two-stage turn box is influenced by physical dimension (how many bicyclists it can contain) and signal phasing (how frequently the box clears.)

## Crash Reduction

There are no Crash Modification Factors (CMFs) available for this treatment.

## Construction Costs

Costs will vary due to the type of paint used and the size of the two-stage turn box, as well as whether the treatment is added at the same time as other road treatments.

The typical cost for painting a two-stage turn box is \$11.50 per square foot.



## Bike Lanes at Intersections where Right Turns Are Permitted

When a bicycle lane approaches an intersection adjacent to a through/right option lane, the bicycle lane should be designed to permit right turning vehicles to enter the bicycle lane prior to turning.

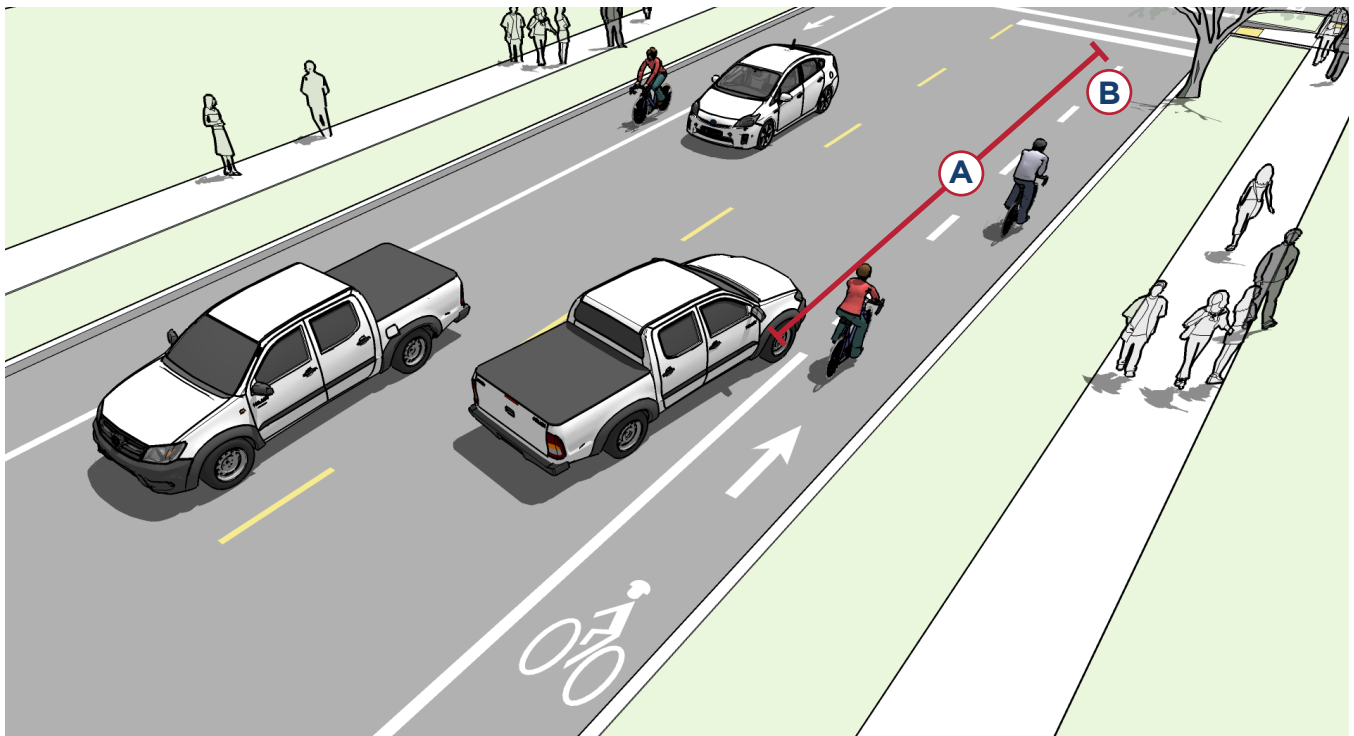

### Typical Application

- Streets with curbside bicycle lanes approaching an intersection where right turns are permitted.
- Streets with curb extensions occupying the parking lane at intersections.
- Consider a Combined Bike Lane/Turn Lane in areas with on-street parking and high turn volumes, but not enough room for a bicycle lane and a right turn only lane.

### Design Features

- A** Where motorist right turns are permitted from the general purpose travel lane, the solid bike lane should be dashed 50 to 200 feet in advance of the intersection.
- B** Dotted striping should be 4 inch-wide lines in 2 foot segments with 6 foot gaps. (Texas Traffic Standard BLPM-10)



*Figure C6. The dashed bike lane line on Lincoln Village Dr signals to drivers that they should enter the bike lane to make their right turn.*

## Further Considerations

- The City of Sacramento is experimenting with dashed green pavement in the approach to intersections.

## Crash Reduction

Studies have shown a 40 percent decrease in crashes at signalized intersections with through/right lanes when compared to sharing the roadway with motor vehicles. (CMF ID: 3255)

## Construction Costs

The cost for installing bicycle lanes will depend on the implementation approach. On roadways with adequate width for reconfiguration or restriping, costs may be negligible when provided as part of routine overlay or repaving projects.

Typical costs are \$16,000 per mile for restriping.





Figure C7. Drivers wishing to enter the right turn lane must transition across the bicycle lane in advance of the turn.

## Further Considerations

- The bicycle lane maintains a straight path, and drivers must weave across, providing clear right-of-way priority to bicyclists.
- Maintaining a straight bicycle path reinforces the priority of bicyclists over turning cars. Drivers must yield to bicyclists before crossing the bike lane to enter the turn only lane.
- Through lanes that become turn only lanes are difficult for bicyclists to navigate and should be avoided.
- The use of dual right-turn-only lanes should be avoided on streets with bike lanes (AASHTO, 2013). Where there are dual right-turn-only lanes, the bike lane should be placed to the left of both right-turn lanes, in the same manner as where there is just one right-turn-only lane.

## Crash Reduction

Studies have shown a 3 percent decrease in crashes at signalized intersections with exclusive right turn lanes when compared to sharing the roadway with motor vehicles. (CMF ID: 3257)

## Construction Costs

The cost for installing bicycle lanes will depend on the implementation approach. On roadways with adequate width for reconfiguration or restriping, costs may be negligible when provided as part of routine overlay or repaving projects.

Typical costs are \$16,000 per mile for restriping.



## Bike Lanes at Through Lane to Right Turn Lane Transition

When a through lane transitions directly into a right turn only lane, bicyclists traveling in a curbside bike lane must move laterally to the left of the right turn lane. Designers should provide the opportunity for bicyclists to accept gaps in traffic and control the transition.

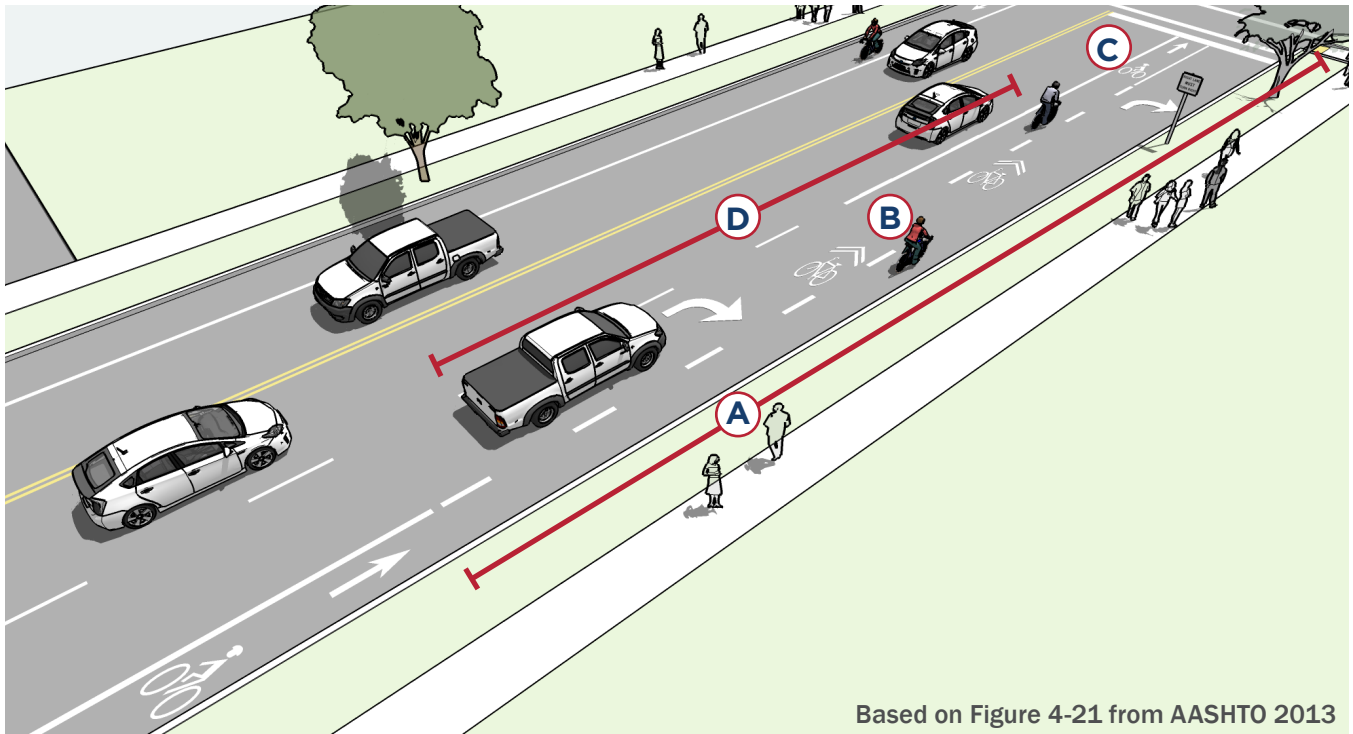

Based on Figure 4-21 from AASHTO 2013

### Typical Application

- Streets with curbside bike lanes where a moderate-high speed ( $\geq 30$  mph) through travel lane transitions into a right turn only lane.
- This treatment functions for skilled riders, but is not appropriate for riders of all ages and abilities. If a low stress crossing is desired in these locations, consider a Protected Bicycle Signal Phase.

### Design Features

- A** End the curbside bike lane with dashed lines at least 125 in advance of the intersection to indicate to bicyclists to enter the general purpose travel lane.
- B** Use Shared Lane markings in the general purpose to raise awareness to the presence of bicyclists in the travel lanes during the transition segment..
- C** Reestablish a standard or wide bicycle lane to the left of the right turn lane.
- D** The transition area should be a minimum of 100 feet long.



*Figure C8. When a through travel lane is “dropped” and transitions directly into a right turn only lane, only confident adult riders can be expected to transition across the lane into the through bike lane. Designers should provide adequate room for bicyclists to take advantage of gaps in traffic, and not prescribe a defined travel path across the turn lane.*

## Further Considerations

The design should not suggest to bicyclists that they do not need to yield to motorists when moving laterally. This differs from added right turn lanes in important details:

- Do not use a R4-4-YIELD TO BIKES sign
- The bike lane line should not be striped diagonally across the travel lane (with or without colored pavement), as this inappropriately suggests to bicyclists that they do not need to yield to motorists when moving laterally.

Right turn only drop lanes should be avoided where possible. Alternative design strategies include roadway reconfigurations to remove the dropped lane, or bicycle signals with a protected signal phase to eliminate turning conflicts.

## Crash Reduction

There are no Crash Modification Factors (CMFs) available for this treatment.

## Construction Costs

The cost for installing bicycle lanes will depend on the implementation approach. On roadways with adequate width for reconfiguration or restriping, costs may be negligible when provided as part of routine overlay or repaving projects.

Typical costs are \$16,000 per mile for restriping.





Figure C9. Shared lane markings and signs indicate that bicyclists should ride on the left side of this right turn only lane.

## Further Considerations

- This treatment is recommended at intersections lacking sufficient space to accommodate both a standard through bike lane and right turn lane.
- Not recommended at intersections with high peak motor vehicle right turn movements.
- Combined bike lane/turn lane creates safety and comfort benefits by negotiating conflicts upstream of the intersection area.

## Crash Reduction

A survey in Eugene, OR found that more than 17 percent of the surveyed bicyclists using the combined turn lane felt that it was safer than the comparison location with a standard-width right-turn lane, and another 55 percent felt that the combined-lane site was no different safety-wise than the standard-width location.<sup>1</sup>

## Construction Costs

The cost for installing a combined turn lane will depend on the implementation approach. On roadways with adequate width for reconfiguration or restriping, costs may be negligible when provided as part of routine overlay or repaving projects.

Typical costs are \$16,000 per mile for restriping. Typical yield lines cost \$10 per square foot or \$320 each. Typical shared lane markings cost \$180 each.

<sup>1</sup> Hunter, W.W. (2000). Evaluation of a Combined Bicycle Lane/Right-Turn Lane in Eugene, Oregon. Publication No. FHWA-RD-00-151, Federal Highway Administration, Washington, DC.



## Mixing Zone

A mixing zone creates a shared travel lane where turning motor vehicles yield to through traveling bicyclists. Geometric design is intended to slow motor vehicles to bicycle speed, provide regulatory guidance to people driving, and require all users to negotiate conflicts upstream of the intersection.

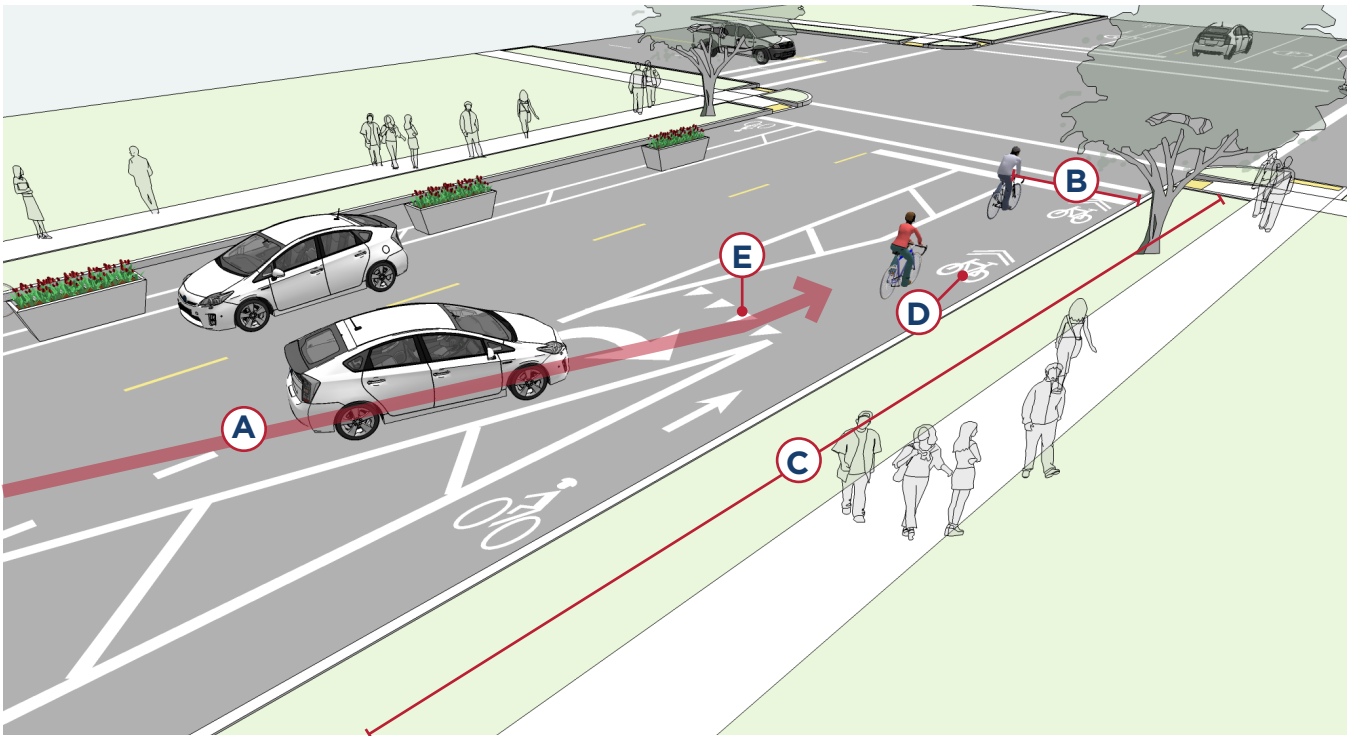

### Typical Application

- Most appropriate in areas with low to moderate right-turn volumes
- Streets with a right turn lane but not enough width to have a standard width bicycle lane at the intersection.

### Design Features

- A** Use short transition taper dimensions and short storage length to promote slow motor vehicle travel speeds.
- B** The width of the mixing zone should be 9 feet minimum and 13 feet maximum.
- C** The transition to the mixing zone should begin 70 feet in advance of the intersection.
- D** Shared lane markings (TMUTCD 9C-9) should be used to illustrate the bicyclist's position within the lane.
- E** A yield line should be used in advance of the intersection.



Figure C10. Mixing Zone (Photo via NACTO)

## Further Considerations

- Not recommended at intersections with high peak motor vehicle right turn movements.
- The zone creates safety and comfort benefits by having the mixing zone upstream of the intersection conflict area.

## Crash Reduction

A survey of separated bike lane users in the United States found the 60-80 percent of respondents agreed with the statement “I generally feel safe when bicycling through the intersections” when asked about intersections with mixing zone approaches.<sup>1</sup>

## Construction Costs

The cost for installing mixing zone will depend on the implementation approach. On roadways with adequate width for reconfiguration or restriping, costs may be negligible when provided as part of routine overlay or repaving projects.

Typical costs are \$16,000 per mile for restriping. Typical yield lines cost \$10 per square foot or \$320 each. Typical shared lane markings cost \$180 each.

<sup>1</sup> NITC. Lessons from the Green Lanes. 2014.

## Protected Bicycle Signal Phase

Protected bicycle lane crossings through signalized intersections can be accomplished through the use of a bicycle signal phase which reduces conflicts with motor vehicles by separating bicycle movements from any conflicting motor vehicle movements. Bicycle signals are traditional three lens signal heads with green, yellow and red bicycle stenciled lenses.

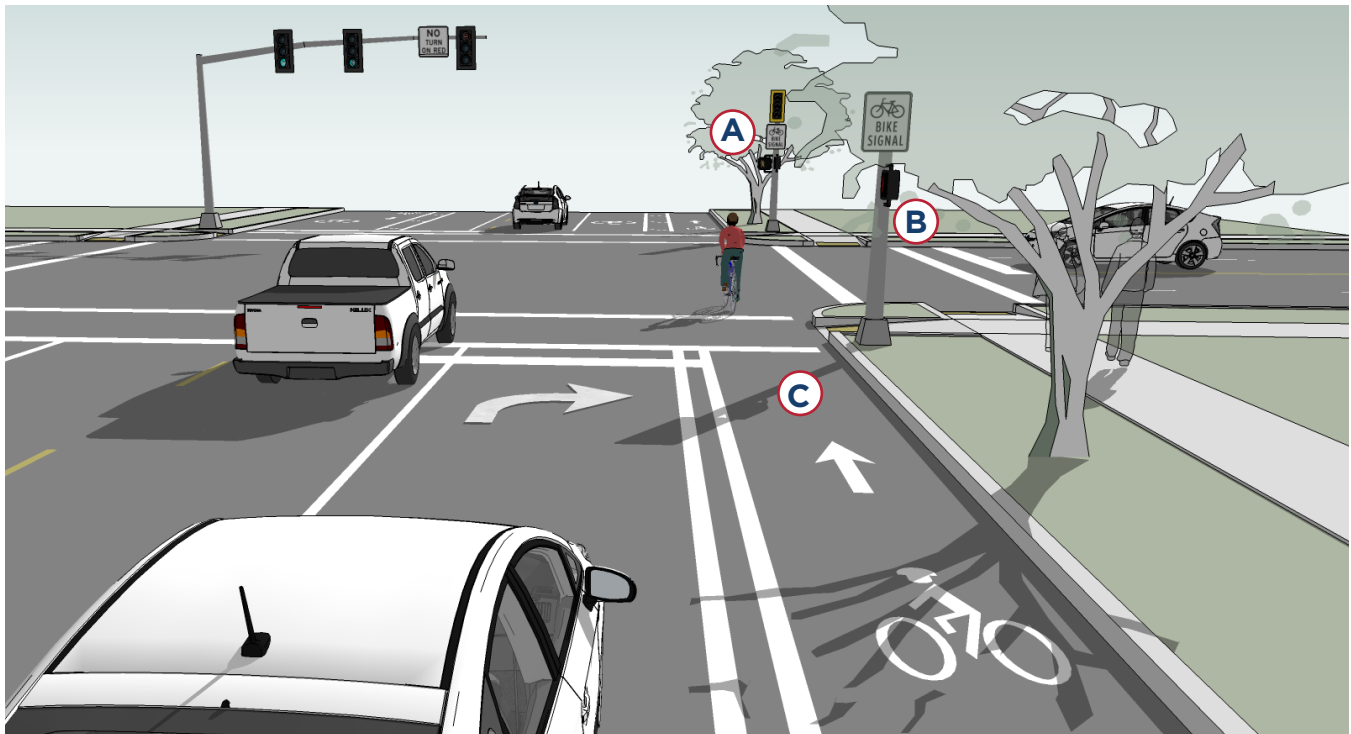

### Typical Application

- Two-way protected bike lanes where contraflow bicycle movement or increased conflict points warrant protected operation.
- Bicyclists moving on a green or yellow signal indication in a bicycle signal shall not be in conflict with any simultaneous motor vehicle movement at the signalized location
- Right (or left) turns on red should be prohibited in locations where such operation would conflict with a green bicycle signal indication.

### Design Features

- **A** An additional “Bicycle Signal” sign should be installed below the bicycle signal head.
- **B** Designs for bicycles at signalized crossings should allow bicyclists to trigger signals and safely maneuver the crossing.
- **C** On bikeways, signal timing and actuation shall be reviewed and adjusted to consider the needs of bicyclists. (TMUTCD 9D.02)



Figure C11. A bicycle signal head at a signalized crossing creates a protected phase for cyclists to safely navigate an intersection.



Figure C12. A bicycle detection system triggers a change in the traffic signal when a bicycle is detected.

## Further Considerations

- A bicycle signal should be considered for use only when the volume/collision or volume/geometric warrants have been met.
- FHWA has approved bicycle signals for use, if they comply with requirements from F.C. Interaction Approval 16 (I.A. 16).
- Bicyclists typically need more time to travel through an intersection than motor vehicles. Green light times should be determined using the bicycle crossing time for standing bicycles.
- Bicycle detection and actuation systems include user-activated buttons mounted on a pole, loop detectors that trigger a change in the traffic signal when a bicycle is detected and video detection cameras, that use digital image processing to detect a change in the image at a location.

## Crash Reduction

A survey of separated bike lane users in the United States found the 92 percent of respondents agreed with the statement “I generally feel safe when bicycling through the intersections” when asked about an intersection with a protected bicycle signal phase.<sup>1</sup>

## Construction Costs

Bicycle signal heads have an average cost of \$12,800.

Video detection camera system costs range from \$20,000 to \$25,000 per intersection.

<sup>1</sup> NITC. Lessons from the Green Lanes. 2014.



## Bike Lanes at Channelized Turn Lanes

Bicycle friendly channelized turn lanes can reduce the risk of potential conflicts between bicyclists and turning vehicles by improving sight lines of turning vehicles, slows turning vehicle speed, and reminding users of bicycle priority in weave areas.

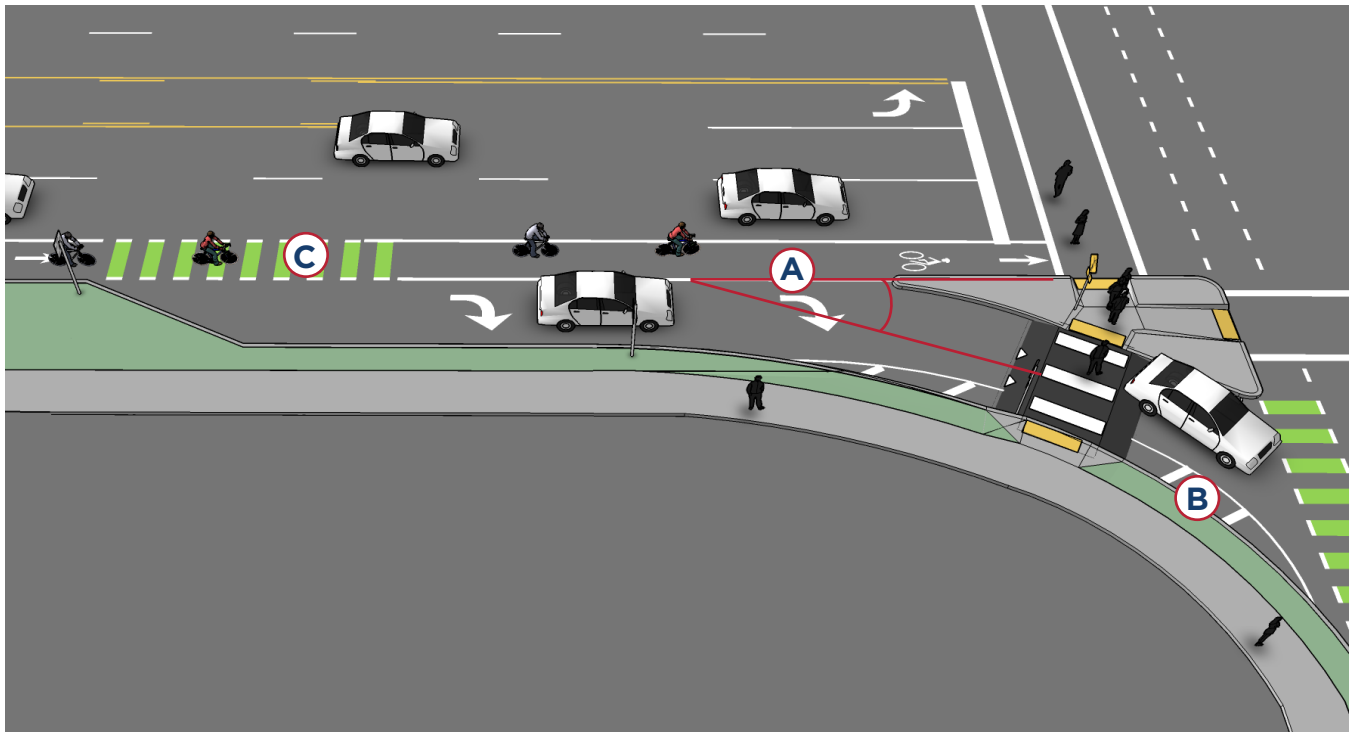

### Typical Application

- At signalized intersections.
- Intersections with high right turn traffic volumes, and very low levels of pedestrian activity.
- Increase intersection efficiency and reduce unnecessary delay at areas with high right-turn traffic volumes.
- Wide streets with long crossing distances.
- As an improvement to intersections with an existing traditional channelized right-turn lane.

### Design Features

- (A) The preferred angle of approach is no more than 15-30 degrees.
- (B) Design the right turn lane to encourage appropriate deceleration in preparation for yielding to crossing pedestrians.
- (C) Colored pavement markings should be used at locations where motor vehicles are directed to weave across bicycle lanes. (NACTO, 2012)



Figure C13. This example uses a raised, mountable apron at the corner to define a tight corner radius for passenger cars.

## Further Considerations

- In locations where a large curb radius is necessary to accommodate large vehicles, use a painted or raised apron to define a secondary curb radius for passenger cars.
- High-speed channelized right turn lanes resulted in the greatest pedestrian delay and risk. High Speed is categorized as a design speed or average observed speed at the crosswalk greater than 20 mph. these locations are good candidates for additional interventions to increase yielding.
- A raised pedestrian crossing may be used to slow driver speeds, encourage yielding, and prioritize crossing pedestrians over turning vehicles. A raised crossing is recommended if the posted speed is 30 mph/hour or less and turn volumes are 6,000 ADT or less.
- If further yielding compliance is needed, active warning beacons such as a Rectangular Rapid Flashing Beacon (RRFB) may be used.<sup>1</sup>

<sup>1</sup> TRB. NCHRP 674: Crossing Solutions at Roundabouts and Channelized Turn Lanes for Pedestrians with Vision Disabilities. 2011.

## Crash Reduction

There are no Crash Modification Factors (CMFs) for this treatment.

NCHRP 562 identifies raised crosswalks, sound strips and rapid flash beacons as methods to improve conditions for pedestrians.

## Construction Costs

The cost for installing bicycle lanes at interchange ramps will depend on the implementation approach. On roadways with adequate width for reconfiguration or restriping, costs may be negligible when provided as part of routine overlay or repaving projects.

## Bike Lanes at Entrance Ramps

Arterials may contain high speed freeway-style designs such as merge lanes which can create difficulties for bicyclists. The entrance lanes typically have intrinsic visibility problems because of low approach angles and feature high speed differentials between bicyclists and motor vehicles.

Low Speed Entrance Ramp (Bicycle Priority)

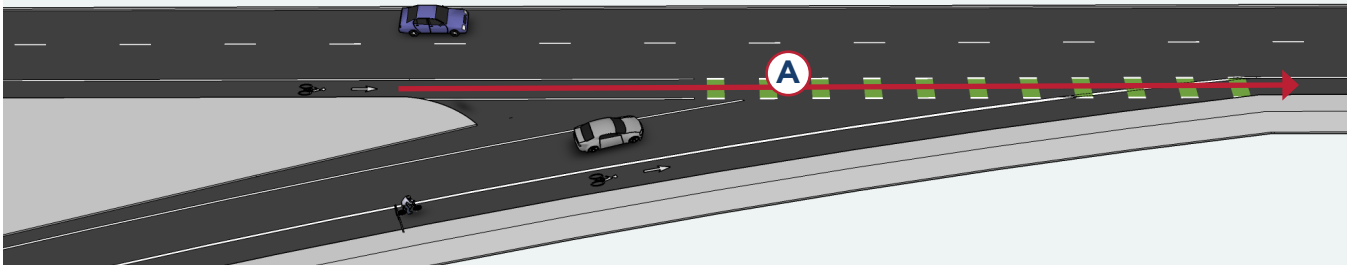

High Speed Entrance Ramp (Motor Vehicle Priority)

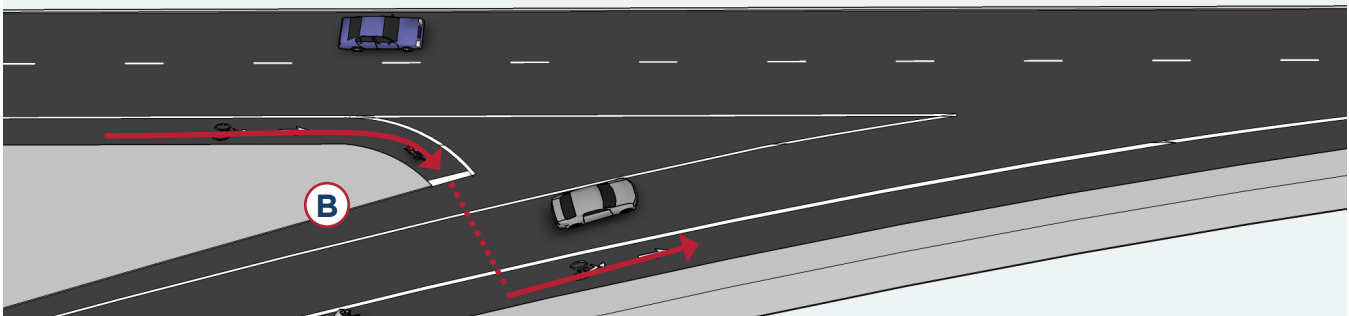

### Typical Application

- Streets with high speed freeway style merge lanes.
- Where users are skilled adult riders.
- Design strategies differ for low-speed and high-speed configurations.

### Design Features

On low-speed entrance ramps ( $\leq 35$  mph) the bike lane should travel straight through the merge area.

- Ⓐ Use dotted lines, colored pavement and signs to define bicyclist priority over merging traffic.

At high-speed entrance ramps ( $\geq 40$  mph), with dedicated receiving lanes, bicyclists should be encouraged to yield to merging traffic and cross when safe.

- Ⓑ Angle the bike lane to increase the approach angle with entering traffic, and position the crossing before the drivers' attention is focused on the upcoming merge.



*Figure C14. Bicyclists are channelized in advance of the crossing to encourage them to yield to entering motor vehicles in this example from Portland, OR.*

## Further Considerations

Even with signage and striping improvements, free-flow ramps present significant challenges for pedestrians and bicyclists; reconfiguring the intersection is the preferred treatment. (Caltrans Complete Intersections, 2010)

## Crash Reduction

There are no Crash Modification Factors (CMFs) available for this configuration.

## Construction Costs

The cost for installing bicycle lanes at interchange ramps will depend on the implementation approach. On roadways with adequate width for reconfiguration or restriping, costs may be negligible when provided as part of routine overlay or repaving projects.

**Proper ramp alignment is easiest to achieve when the intersection is still in the planning phase; once constructed, interchanges are very costly to reconfigure.**



## Bike Lanes at Exit Ramps

Arterials with freeway-style exit ramps can create difficulties for bicyclists. Exit lanes typically have intrinsic visibility problems because of low approach angles and feature high speed differentials between bicyclists and motor vehicles.

Low Speed Exit Ramp (Bicycle Priority)

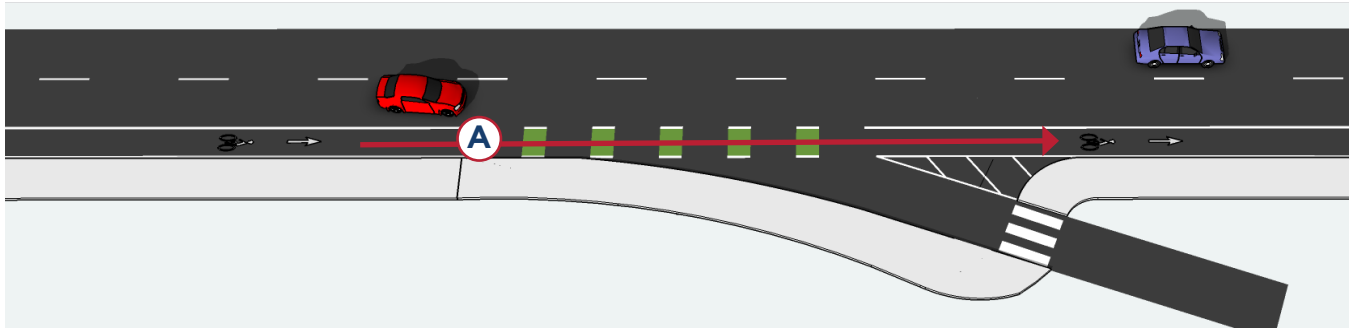

High Speed Exit Ramp (Motor Vehicle Priority)

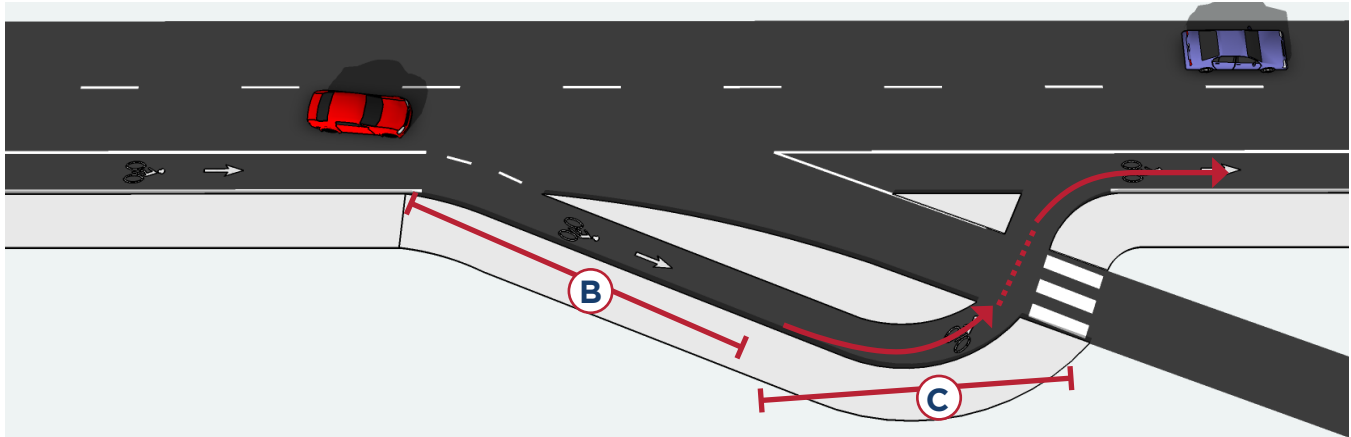

### Typical Application

- Streets with bicycle lanes
- Streets with freeway style exit ramps.
- Where the expected user is a skilled adult rider.

### Design Features

On low-speed exit ramps ( $\leq 40$  mph), the bike lane should travel straight through the merge area.

- A** Use dotted lines, colored pavement and signs to define bicyclist priority.

On high-speed exit ramps ( $\geq 45$  mph), use a jug handle turn to bring bicyclists to a visible location with exiting traffic.

- B** 45 foot (35 foot minimum) taper from roadway.
- C** 45 foot (35 foot minimum) jughandle turn .



*Figure C15. In constrained conditions, bicyclists may exit onto the sidewalk and complete the maneuver with pedestrians in the crosswalk, as in this example from Portland, OR. Bicyclists may choose to exit the bike lane and make a vehicular style transition if they prefer.*

## Further Considerations

Grade separated crossings are preferred over at-grade crossings to offer low-stress crossings of high-speed interchange ramps. Grade separation designs utilizing a bicycle path could be used if the approach ramp elevations are appropriate, and if bicycle volumes are fairly high and motor traffic volumes are high. Standard bicycle path geometric guidelines would be applied to the approaches to a grade separated crossing for a bikeway.

## Crash Reduction

There are no Crash Modification Factors (CMFs) available for this configuration.

## Construction Costs

The cost for installing bicycle lanes at interchange ramps will depend on the implementation approach. On roadways with adequate width for reconfiguration or restriping, costs may be negligible when provided as part of routine overlay or repaving projects.

**Proper ramp alignment is easiest to achieve when the intersection is still in the planning phase; once constructed, interchanges are very costly to reconfigure.**

## Bicycle Detection and Actuation

Proper bicycle detection should meet two primary criteria: 1) accurately detects bicyclists and 2) provides clear guidance to bicyclists on how to actuate detection (e.g., what button to push, where to stand). Bicycle loops and other detection mechanisms can also provide bicyclists with an extended green time before the light turns yellow so that bicyclists of all abilities can reach the far side of the intersection.

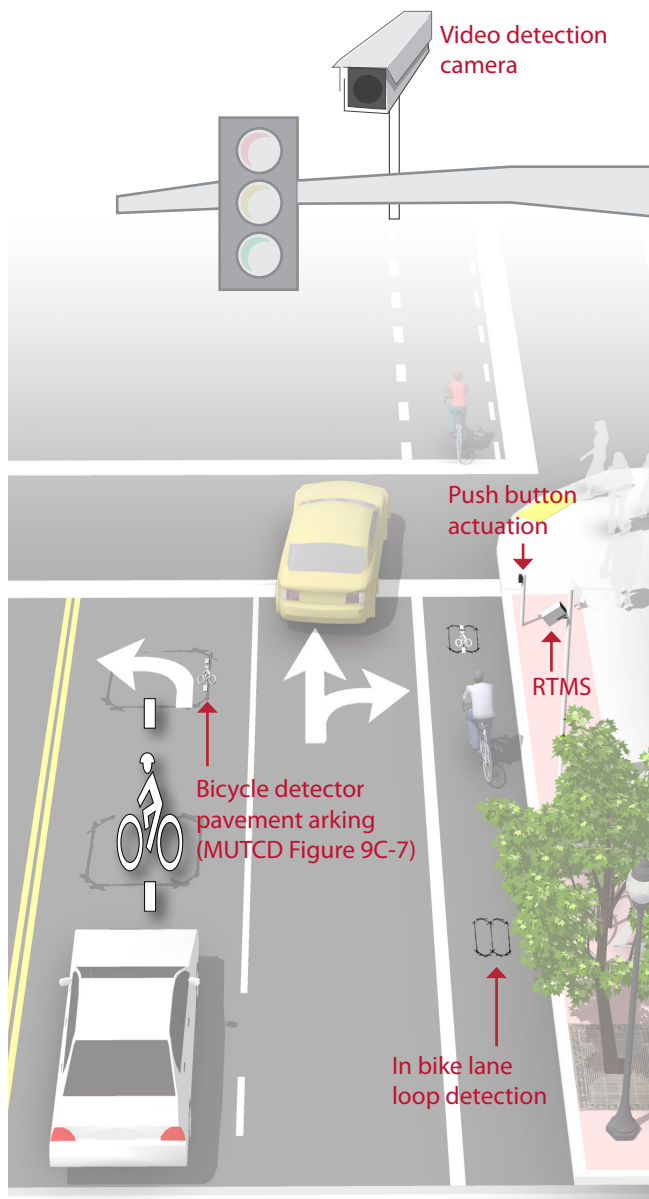

### Typical Application

- All new or modified traffic signals in California must be equipped for bicyclist detection, or be placed on permanent recall or fixed time operation. (CalTrans Traffic Operations Policy Directive (TOPD) 09-06.
- Detection shall be placed where bicyclists are intended to travel and/or wait.
- On bicycle priority corridors with on-street bike lanes or separated bikeways, consider the use of advance detection placed 100-200' upstream of the intersection to provide an early trigger to the signal system and reduce bicyclist delay.

### Design Features

TOPD 09-06 requires push button, in-pavement detectors or video detection systems.

#### Push Button Actuation

User-activated button mounted on a pole facing the street. Device location should not require bicyclists to dismount or be rerouted out of the way or onto the sidewalk to activate the phase.

#### In Pavement Detection (Type D inductive loop)

Bicycle-activated loop detectors are installed within the roadway to allow the presence of a bicycle to trigger a change in the traffic signal. This allows the bicyclist to stay within the lane of travel without having to maneuver to the side of the road to trigger a push button. Loops should be supplemented with pavement markings to instruct bicyclists how to trip them.



Figure C16. Bicycle push button actuators are positioned to allow bicycle riders in roadway to stop traffic on busy cross-streets.

### Further Considerations

- Video detection systems use digital image processing to detect a change in the image at a location. These systems can be calibrated to detect bicycles, although some video detection systems may have problems detecting bicyclists under poor lighting or poor weather conditions.
- It is important for signal timing to account for the differing bicycle start up and clearance time through the intersection. The sum of the minimum green time, plus the yellow change interval plus any red clearance interval should allow a 6 ft bicyclist to clear the last conflicting lane at a speed of 14.7 ft/sec plus an additional start up time of 6 seconds.
- Signal detection and actuation for bicyclists should be maintained with other traffic signal detection and roadway pavement markings. In street detection markings are often placed within the wheel tread of motor vehicles and may be susceptible to early wear.
- Studies have shown limited comprehension of the bicycle detection pavement marking by bicyclists. The MUTCD R10-22 sign may be used to help educate and inform road users.

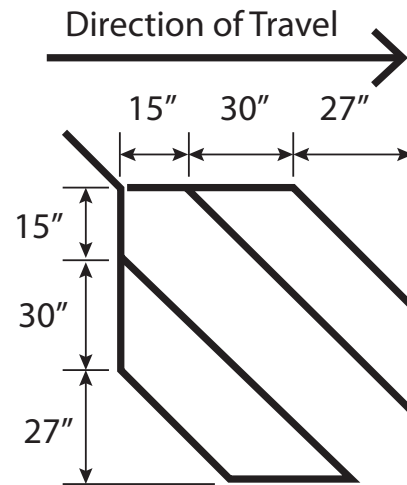

Figure C17. Type D loop detector have been shown to most reliably detect bicyclists at all points over their surface.

### Crash Reduction

Properly designed bicycle detection can help deter red light running and unsafe behaviors by reducing delay at signalized intersections.

### Construction Costs

Costs vary depending on the type of technology used. Embedded in pavement loop detectors have an average cost of \$1,900. Video camera system costs range from \$20,000 to \$25,000 per intersection.



## Driveways and Minor Streets

The added separation provided by protected bike lane creates additional considerations at intersections and driveways when compared to conventional bicycle lanes.

At driveways and crossings of minor streets bicyclists should not be expected to stop at if the major street traffic does not stop.

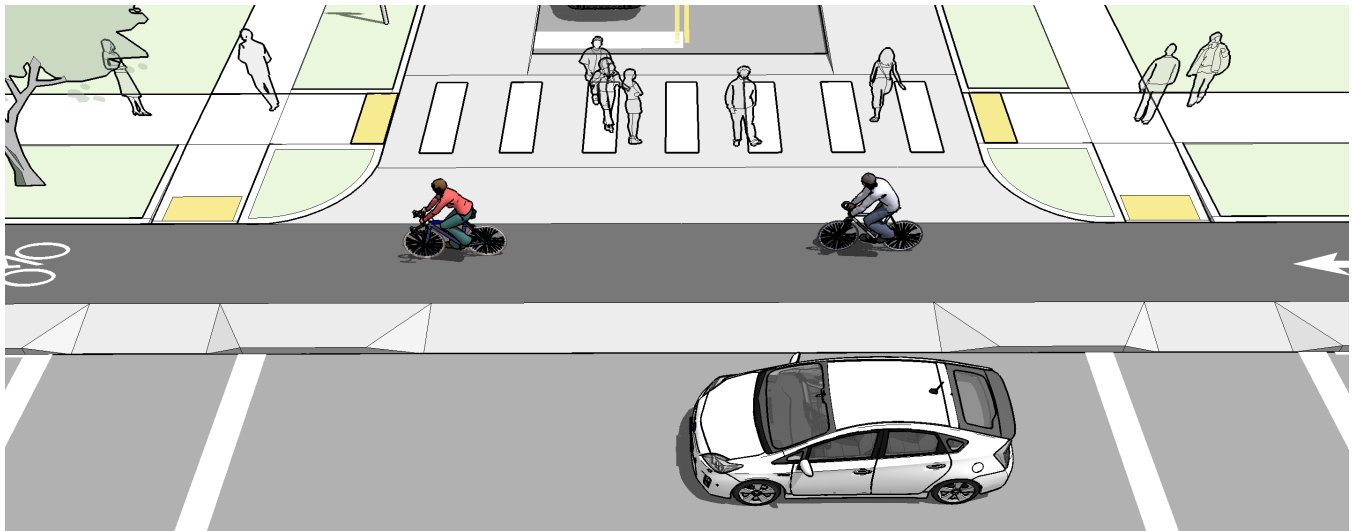

*Figure C18. Prohibiting parking in advance of driveways and intersections is required to create a clear sight triangle for drivers. Faster operating speeds require larger clear sight triangles.*

### Benefits

- Removing obstructions before crossings increases visibility of bicyclists.
- Treatments designed to constrain and slow turning motor vehicle traffic will slow drivers to bicycle-compatible travel speeds prior to crossing the protected bike lane.

### Application Criteria

- If raised, maintain the height of the protected bike lane through the crossing, requiring automobiles to cross over.
- Remove parking 30 feet prior the intersection.
- Use colored pavement markings and/or shared lane markings through the conflict area.
- Place warning signage to identify the crossing.

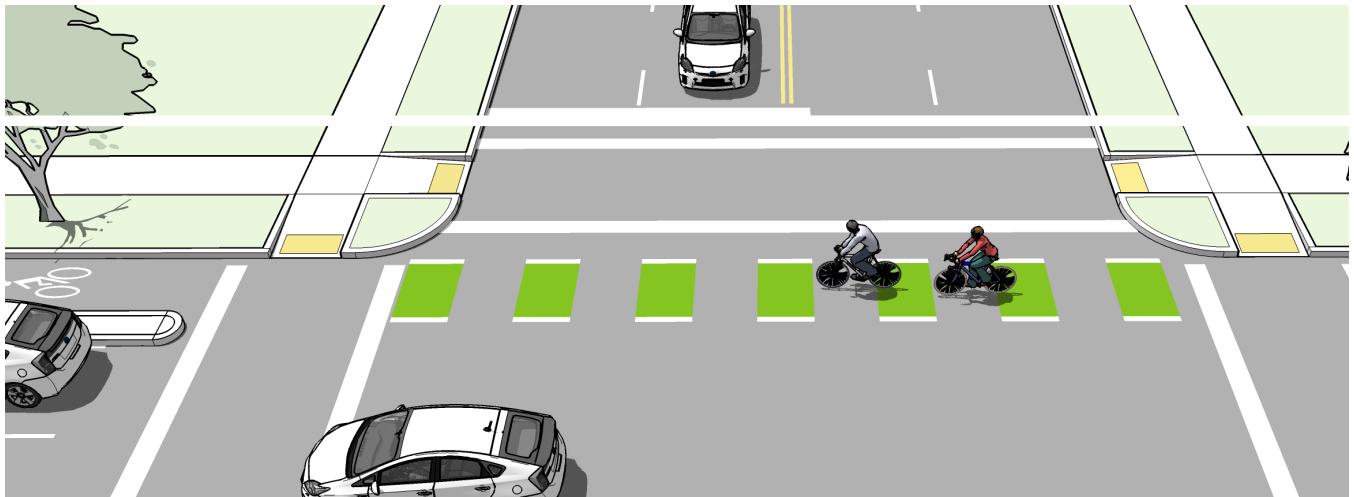
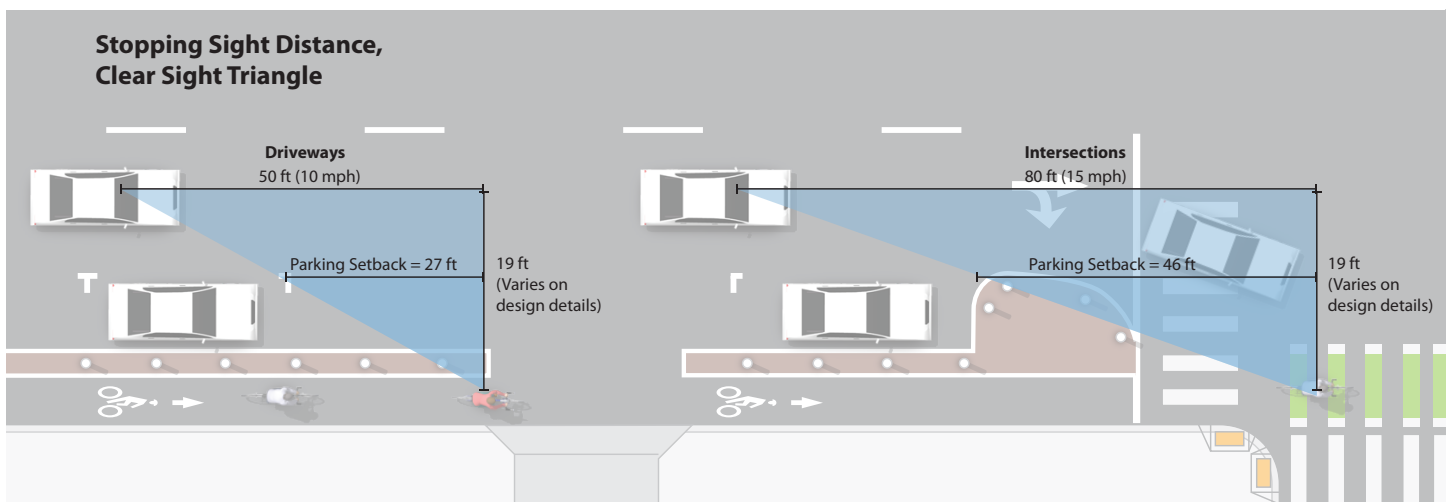

Figure C19. Prohibiting parking in advance of driveways and intersections is required to create a clear sight triangle for drivers. Faster operating speeds require larger clear sight triangles.



## Bicycle Priority at Signals

Bikeway crossings of signalized intersections can be accomplished through the use of a Protected Bicycle Phase, which reduces conflicts with motor vehicles by separating bicycle movements from any conflicting motor vehicle movements, or through a Leading Bicycle Interval, which offers a head start crossing for people riding bicycles.



Figure C20. A bike lane adjacent to double right turn lanes normally requires a stressful, difficult maneuver to avoid conflict. With a bicycle signal, conflict is regulated and the conditions are improved.

### Benefits

- Bicycle signals simplify bicycle movements through complex intersections and clarify operations for all road users.
- A protected bicycle phase eliminates conflicting movements at signalized intersections.
- A leading bicycle interval reduces conflict by prioritizing bicycle movements with a head start over motor vehicle traffic.

### Typical Application

#### Protected Phase

- Two-way or contra-flow (opposite direction) bicycle lanes where unconventional bicycle movement or increased conflict points warrant protected operation.
- Used where right-turn volumes are typically over 150 per hour.

#### Leading Interval

- Appropriate in large intersections.
- Pairs with what would otherwise be permissive conflicting movements.
- 2-3 seconds leading interval allow people riding bicycles to take a primary position within the intersection.

## Signal Phase Diagrams

The diagrams below are examples of signal cycle patterns to accommodate protected or leading bicycle signal phases. These are simple examples that may be combined and overlapped in a variety of ways in response to site specific conditions.

### Protected but Concurrent Bicycle Phase

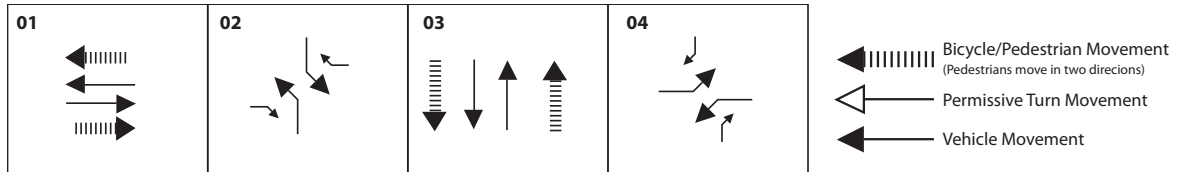

### All-Direction Protected Bicycle Phase (Scramble)

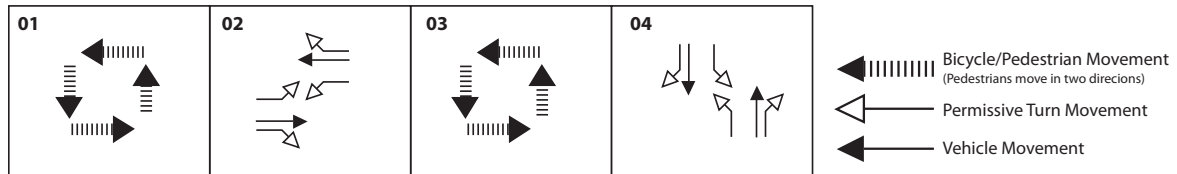

### Leading Bicycle Interval

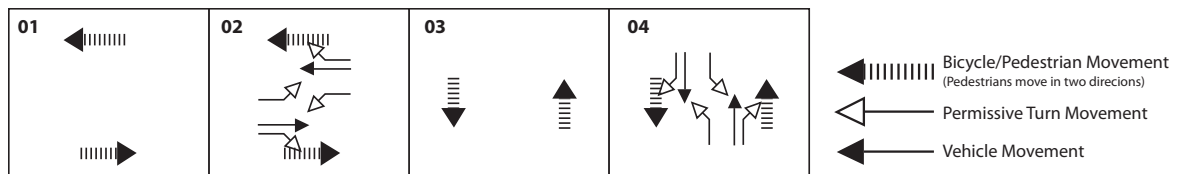

## Bicycle Signal Design Features

- Bicycle signal head shall be placed in a location clearly visible to people approaching by bicycle.
- Supplemental “bicycle signal” sign (MUTCD R10-10b) is required.
- “No Turn on Red” (MUTCD R10-11) is necessary when bicycle signal is green to prevent conflicts and to meet FHWA regulations.
- Signal detection should be reliable, in the form of well placed loop detection, pushbutton or microwave detectors.
- Consider the use of a countdown signal (shown at right) or a detection indicator light for positive indication of bicycle detection.



Figure C21. A countdown signal beside the bicycle signal head informs waiting bicyclists of the time remaining until a green signal.

## Further Considerations

Bicycle signal heads are permitted by FHWA per Interim Approval 16 (IA-16). This approval is compatible with exclusive or protected-but-concurrent bicycle signals, but does not permit leading bicycle intervals or all-direction bicycle phases.

Provide at least 5-7 seconds of green time for bicycle movements. Yellow signals should be between 3-6 seconds, with longer yellows recommended for wider intersections so that people crossing by bicycle are not as worried about being in conflict with cross-traffic.



## Bicycle Boulevards

Bicycle boulevards are low-volume, low-speed streets modified to enhance bicyclists' and pedestrians' experience by using treatments such as signage, pavement markings, traffic calming and/or traffic reduction, and intersection modifications. Bicycle boulevards discourage through trips by motor vehicles, while accommodating local access. Intersection crossing treatments (particularly at arterial crossings) are used to create safer, more comfortable, and convenient bicycle and pedestrian-optimized streets.



Figure C22. Bicycle boulevards incorporate signs, pavement markings, and traffic calming measures to discourage through trips by motor vehicles while accommodating local access.

### Benefits

- Provide people of all ages and abilities with comfortable and attractive places to walk and ride a bicycle.
- Provide arterial street crossing improvements for safer and more comfortable travel
- People riding bicycles feel comfortable bicycling two abreast or “conversation riding” while traveling on bicycle boulevards.

### Application Criteria

- Bicycle boulevards should be developed on streets that improve connectivity to key destinations and provide a direct route for bicyclists.
- Bicycle boulevards parallel to commercial streets improve access for “interested but concerned” bicyclists and complement bike lanes on major roadways.
- Local streets with existing traffic calming, traffic diversions, or signalized crossings of major streets are good candidates, as they tend to be existing bicycle routes and have low motor vehicle speeds and volumes

## Design Elements

- Signs and pavement markings are the minimum treatments necessary to designate a street as a bicycle boulevard. Together, they visibly designate a roadway to both bicyclists and motorists. Signs, and in some cases pavement markings, provide wayfinding to help bicyclists remain on the designated route.
- Common vertical traffic calming elements employed to reduce vehicle speed include speed humps, speed tables and raised crosswalks, which help to slow motor vehicles.
- Horizontal traffic calming elements like curb extensions, chicanes, chokers, and traffic circles cause drivers to slow down by restricting the roadway space or by requiring careful maneuvering. Such measures



Figure C23. A combination of pavement markings and distinct signs distinguish bicycle boulevards from other shared travel lanes.



Figure C25. Traffic circles have proven to be effective intersection treatments for bicycle boulevards.

may reduce the design speed of a street, and can be used in conjunction with reduced speed limits to reinforce the expectation of lowered speeds.

- Intersection improvements are aimed at improving safety for all road users while giving priority to bicycle movements. These include stop signs at cross-streets, traffic circles, curb extensions, bike boxes, median islands, hybrid beacons, and rectangular rapid flashing beacons.
- Traffic diversion measures are designed to reduce motor vehicle traffic volumes, which in turn increase bicyclists' comfort while also decreasing opportunities for conflict. Such traffic diversion measures include partial closures, diagonal diverters, median diverters, and even full closures.



Figure C24. A raised crosswalk doubles as a speed table to reduce motor vehicle speeds.



Figure C26. Traffic diverters allow through bicycle movements while restricting motor vehicle traffic.

## Protected Intersections

Protected intersections use a variety of design elements to create safe, comfortable conditions for bicyclists, illustrated in Figure 28B. While not all of these elements are required in all situations, they make up the typical protected intersection experience. The protected intersection design is applicable at both signalized and stop controlled intersections.

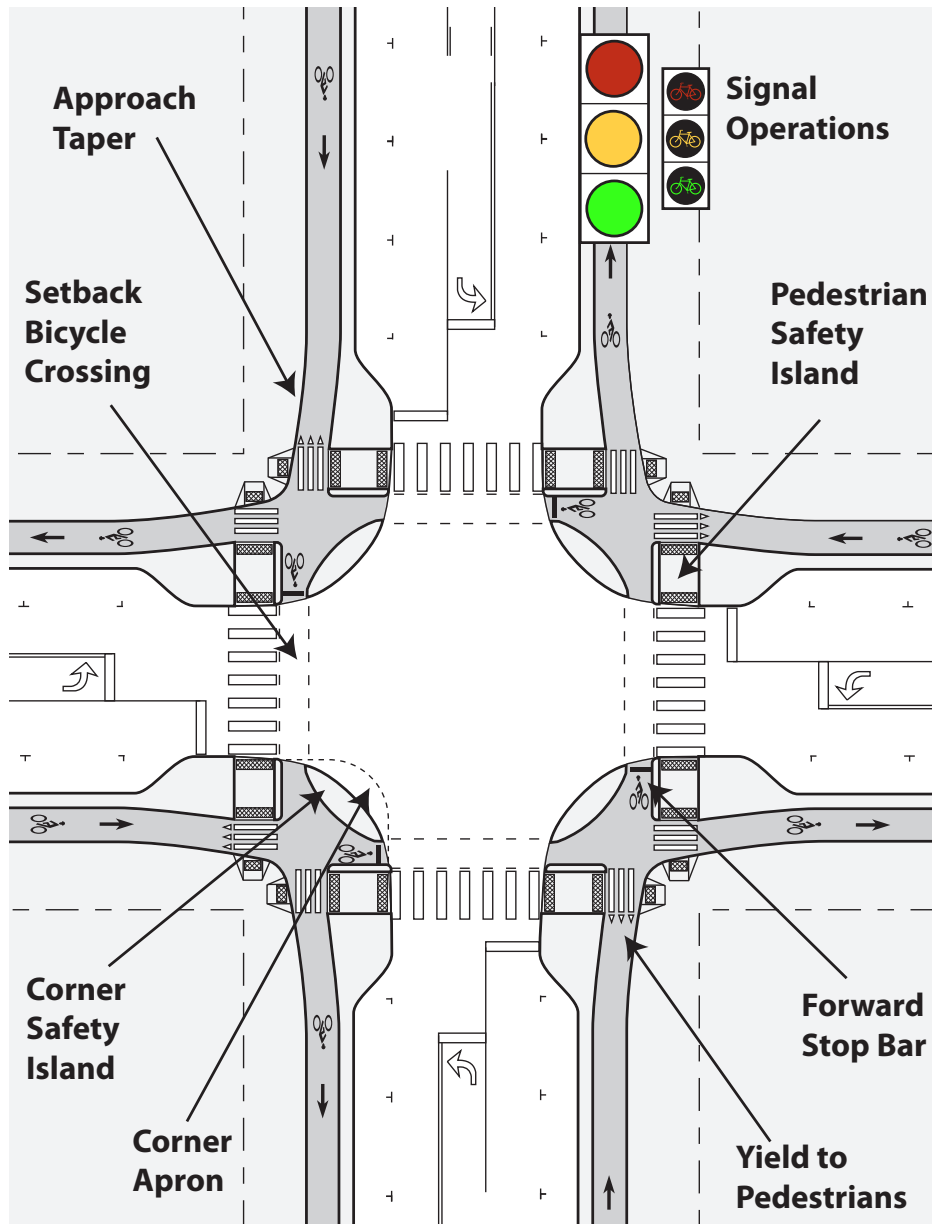

Figure C27. Visual illustration of key protected intersection features

Features	Description
Corner Safety Island	A corner safety island is a raised area that separates the separated bike lane from the general purpose travel lane and defines the corner radius of the intersection. The island provides comfort for waiting bicyclists and may manage the speed of turning vehicles.
Corner Apron	A corner apron is an optional traversable part of the corner safety island that may be needed to accommodate the wheel tracking of large vehicles.
Forward Stop Bar	The forward stop bar marks the location at which bicyclists are intended to stop and wait at a red signal indication.
Approach Taper	The separated bike lane may shift in advance of the intersection to align bicyclists with the setback bicycle crossing. This taper should be subtle to minimize impacts to bicyclists.
Yield for Pedestrians	Bicyclists should yield to crossing pedestrians at the location of pedestrian crosswalks prior to progressing to the forward stop bar. Yield line markings and signs should identify this requirement.
Pedestrian Safety Island	The pedestrian safety island is installed between the separated bike lane and general purpose travel lanes, allowing pedestrians to queue on a DON'T WALK signal and shorten crossing distance of the roadway.
Setback Bicycle Crossing	To improve sightlines and clearly establish priority, the bicycle and pedestrian crossings are set back from that of the adjacent through travel lanes.
Signal Operations	Various signal phasing schemes may be used in combination with geometric design to mitigate or prevent conflict between bicyclists, pedestrians, and turning motor vehicles.

## Further Considerations

When the corner safety island is used to manage permissive turns, the protected intersection designer should pursue all available strategies to minimize the corner radius necessary for vehicle accommodation.

Signalization, lane configuration, and user volumes all have an effect on intersection throughput, delay, and safety. All intersections are unique, and the approaches will need to be adapted to local conditions.

One potential method to mitigate the risk of permissive conflict conditions is to provide a Leading Bicycle Interval (LBI). An LBI is a brief bicycle/pedestrian-only phase that starts a few seconds before the adjacent through movement phase. This allows non-motorized users to establish a presence in the crossing area prior to the arrival of turning vehicles. Turning vehicles must yield to crossing users before proceeding through. Currently, the leading bicycle interval is non-compliant with FHWA IA-16 regulating the use of bicycle signal heads.



This page left blank intentionally.



